



# HILTI S-BT HL SCREW-IN THREADED STUDS

**Hilti S-BT HL Specifications**



## Content

1	Introduction .....	5
1.1	Definition .....	5
1.2	The S-BT HL system .....	6
1.2.1	S-BT HL fastener and designation .....	6
1.2.2	Drilling tool .....	6
1.2.3	Stepped drill bit .....	7
1.2.4	Installation tool .....	7
1.2.5	Stud holder .....	7
1.2.6	Installation temperature and service temperature .....	8
1.3	Fastening mechanism.....	8
1.4	S-BT HL system features and benefits – simplified fastening to steel .....	9
2	Applications .....	10
2.1	Grating fastening system X-FCM.....	10
2.2	Grating fastening system X-FCS-R .....	14
2.3	S-BT HL with MM, MQ and MT installation channel system .....	15
2.4	Fastening instrumentation, junction boxes and lighting.....	16
2.5	Fastening cable / conduit connectors .....	17
2.6	Fastening cable tray supports.....	17
2.7	Electrical connections .....	18
2.7.1	Functional bonding and terminal connection in a circuit .....	19
2.7.2	Protective bonding circuit .....	20
2.7.3	Lightning protection .....	22
3	Technical data .....	24
3.1	Product data.....	24
3.1.1	S-BT HL material specifications and dimensions .....	24
3.1.2	Hilti Coupler material specifications and dimensions .....	25
3.1.3	Standoff adapter material specifications and dimensions .....	25
3.1.4	S-BT HL material properties .....	26
3.1.5	Drilling tool, setting tool, accessories and inserts.....	26
3.2	Load data.....	27
3.2.1	Recommended loads.....	27
3.2.2	Design loads .....	28
3.2.3	Recommended loads S-BT HL with Hilti standoff adapter .....	29
3.2.4	Design loads S-BT HL with Hilti standoff adapter .....	30
3.2.5	Recommended loads S-BT HL with Hilti coupler RC-MF and RC-MR.....	31

3.2.6	Design loads S-BT HL with Hilti coupler RC-MF and RC-MR .....	31
3.2.7	Recommended interaction formula for combined loading – steel and aluminum base materials .....	32
3.2.8	Base material thickness $t_{bl}$ and type of bore hole .....	32
3.2.9	Thickness of fastened material $t_f$ .....	33
3.2.10	Spacing and edge distances .....	34
3.2.11	Installation temperature and service temperature .....	34
3.2.12	Application limit and thickness of base material .....	35
3.2.13	Fastening quality assurance and fastening inspection .....	35
3.2.14	Fastener selection and system recommendation .....	36
3.2.15	Installation details .....	37
4	Performance .....	40
4.1	Nomenclature and symbols .....	40
4.2	Design concepts .....	41
4.3	Static capacity of the S-BT HL threaded stud .....	42
4.3.1	Tensile load deformation behaviour of S-BT HL threaded stud fastenings .....	42
4.3.2	Pull-out strength of S-BT HL threaded stud fastenings .....	44
4.3.3	Shear strength of S-BT HL threaded stud fastenings .....	45
4.4	S-BT HL in stainless steel base material .....	47
4.5	Vibration effects on S-BT HL threaded stud fastenings .....	48
4.6	Resistance of S-BT HL fastenings under dynamic tensile loading .....	55
4.7	Effect of S-BT HL threaded stud fastenings on the fatigue strength of the base material structural steel .....	58
4.8	S-BT-ER (HC) HL and S-BT-EF (HC) HL screw-in threaded studs for electrical connections .....	67
4.8.1	Effect of S-BT-ER HL / S-BT-EF HL studs on integrity of pipe flange .....	68
4.8.2	Permanent current .....	69
4.8.3	Short circuit current .....	70
4.8.4	Lightning current .....	72
4.9	Corrosion resistance .....	74
4.9.1	Selection of a suitable fastener .....	74
4.9.2	Galvanic (contact) corrosion .....	76
4.9.3	Carbon steel S-BT HL studs .....	77
4.9.4	Stainless steel S-BT HL studs .....	78
4.9.5	Conductivity disc of S-BT-ER HL / -EF HL electrical connectors .....	80
4.9.6	Standoff Adapters .....	80
4.9.7	Hilti Coupler RC-MF and RC-MR .....	80
4.9.8	X-FCM grating fasteners .....	81
4.10	Fire resistance .....	82

4.11	Volume swelling of SN 12 sealing washer (stainless steel S-BT HL studs).....	85
5	SPECIAL APPLICATIONS .....	86
5.1	Fastenings to steel with a passive fire protection (PFP) coating.....	86
5.1.1	Multipurpose fastening to steel with a passive fire protection (PFP) coating.....	86
5.1.2	Grating fastening to steel with a passive fire protection (PFP) coating.....	87
5.1.3	Installation details: Fastening S-BT HL threaded studs with standoff adapter to steel with a passive fire protection (PFP) coating.....	88
5.2	Electrical connectors with Hilti standoff adapter to steel with a passive fire protection (PFP) coating .....	89
5.2.1	Electrical connectors S-BT-ER HL with Hilti standoff adapter made of stainless steel to steel with a passive fire protection (PFP) coating (permanent and short circuit current).....	89
5.2.2	Electrical connectors S-BT-ER HL with Hilti standoff adapter made of stainless steel to steel with a passive fire protection (PFP) coating (lightning current) .....	90
5.2.3	Electrical connectors S-BT-ER HL with Hilti High Current standoff adapter M10-HC120 / W10-HC4/0 to steel with a passive fire protection (PFP) coating .....	91
5.3	Applications with standoff adapter e.g. fastening to insulated steel members or insulated bulkheads.....	92
5.4	Installation of S-BT HL with pneumatic tools in e.g. explosive environments .....	93
6	Ordering information.....	95
7	Approvals.....	97
7.1	Offshore and Shipbuilding applications .....	97
7.2	Onshore and Industry applications .....	97

## 1 INTRODUCTION

### 1.1 Definition

The S-BT HL fasteners are threaded studs manufactured from hardened carbon steel 1038 or austenitic-ferritic (Duplex) stainless steel 1.4462 acc. EN 10088-2 (AISI 316L and 318LN equivalent). The S-BT HL threaded studs are fasteners with male threads (metric M8 and M10 or inch W10) for attachment on one end and a threaded tip on the other end for embedment into the structural steel or aluminum. Carbon steel studs are supplied with an aluminum or stainless-steel sealing washer  $\varnothing$  10 mm or  $\varnothing$  12 mm, stainless steel studs are supplied with a stainless-steel sealing washer  $\varnothing$  12 mm, both with a chloroprene rubber sealing ring.

The S-BT HL technology can be used as an alternative to the welds and bolts used to attach materials to structural steel and for fastening applications in shipbuilding environment and offshore structures.

The S-BT HL fastener will be screwed in into a pre-drilled hole. The screw is tapping its own internal mating threads when installed into base material. A special stepped drill bit is needed to ensure an accurately defined pre-drilled hole in terms of borehole depth and diameter. With this system reliable fastenings can be made in steel with a thickness  $3 \text{ mm } [0.12"] \leq t_{II} < 6 \text{ mm } [0.24"]$  and in aluminum with a thickness  $5 \text{ mm } [0.20"] \leq t_{II} < 6 \text{ mm } [0.24"]$  in pre-drilled through holes. For base materials steel and aluminum  $t_{II} \geq 6 \text{ mm } [0.24"]$  the fastener is intended to be set in a pre-drilled blind pilot hole. The benefit of blind holes is no through penetration of the base material. If the real base material thickness  $t_{II}$  exceeds  $6 \text{ mm } [0.24"]$ , no rework of the protective surface coating on the back side is needed. In case of a drill through hole or a pilot hole in thinner base material, rework of the coating on the back side of the plate / profile may be needed. For more details refer to section 3.2.8 "Corrosion information".

#### Note:

The microstructures of duplex stainless steels consist of a mixture of austenite and ferrite phases. Compared to the austenitic stainless steel grades, duplex stainless steels are magnetic. The surface of the S-BT stainless steel fasteners is zinc-coated (anti-friction coating) in order to reduce the thread forming torque when the stud is screwed in into the base material.

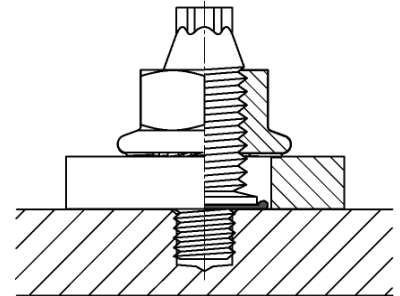

Section of S-BT HL fastener installed in a blind pilot hole

## 1.2 The S-BT HL system

### 1.2.1 S-BT HL fastener and designation

	Stainless steel	Carbon steel
<b>Multipurpose fastening</b>	S-BT-MR M8/7 SN 6 HL	S-BT-MF M8/7 AN 6 HL
	S-BT-MR M8/7 SN 6 HL AL	S-BT-MF M8/15 AN 6 HL
	S-BT-MR M8/15 SN 6 HL	S-BT-MF M10/15 AN 6 HL
	S-BT-MR M8/15 SN 6 HL AL	S-BT-MF W10/15 AN 6 HL
	S-BT-MR M10/15 SN 6 HL	S-BT-MF MT M10/15 AN 6 HL
	S-BT-MR M10/15 SN 6 HL AL	S-BT-MF MT W10/15 AN 6 HL
	S-BT-MR W10/15 SN 6 HL	
	S-BT-MR W10/15 SN 6 HL AL	
<b>Grating fastening</b>	S-BT-GR M8/7 SN 6 HL	S-BT-GF M8/7 AN 6 HL
	S-BT-GR M8/7 SN 6 HL AL	
<b>Electrical connections</b>	S-BT-ER M8/15 SN 6 HL	S-BT-EF M8/15 AN 6 HL
	S-BT-ER M10/15 SN 6 HL	S-BT-EF M10/15 AN 6 HL
	S-BT-ER W10/15 SN 6 HL	S-BT-EF W10/15 AN 6 HL
	S-BT-ER M10 HC120 HL	S-BT-EF M10 HC120 HL
	S-BT-ER W10 HC4/0 HL	S-BT-EF W10 HC4/0 HL

S	Indication of Product of Hilti Business Area <b>S</b> crew Fastening
BT	<b>B</b> lunt Tip
M, G, E	Indication of application. <b>M</b> ultipurpose fastening, <b>G</b> rating fastening, <b>E</b> lectrical connections
R, F	Indication of material or coating. <b>R</b> (Rostfrei = Stainless), <b>F</b> (Duplex coated)
MT	<b>M</b> echanical Trade
M8, M10, W10	Thread type and size
15, 7	Fastening material thickness [mm]
HC	<b>H</b> igh Current
SN, AN	Washer type, SN <b>S</b> tainless steel <b>N</b> eoprene, AN <b>A</b> luminum <b>N</b> eoprene
6	Minimum base material thickness for installation in a blind pilot hole
HL	<b>H</b> igh Load. Second generation of S-BT fasteners with higher resistance values.
AL	Indication of type of base material (AL = <b>A</b> luminum)

### 1.2.2 Drilling tool

Designation	Item Description	Application
SBT 6-22	UCD tool with drill assist	Drilling / Setting

Regarding the drilling time and the bore hole quality, a special tool with optimized revolutions per minute is needed. The cordless drill driver SBT 6-22 is optimized for the drilling and setting process in this application. The SBT 6-22 tool with drill assist in gear 2, BT mode, reduces the speed of the tool automatically when the hole is drilled to the correct depth.



SBT 6-22 drilling / setting tool

### 1.2.3 Stepped drill bit

Designation	Item Description	Application
TS-BT 5.3-65 S	Stepped drill bit for steel base material	Drilling in steel
TS-BT 5.3-95 S	Stepped drill bit for steel base material	Drilling in steel
TS-BT 5.5-74 AL	Stepped drill bit for aluminum base material	Drilling in aluminum
TS-BT 5.3 HC	Stepped drill bit for high current electrical connectors	Drilling in steel

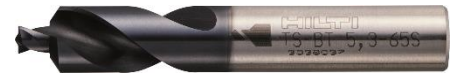

TS-BT 5.3-65 S stepped drill bit

A stepped drill prevents the perforation of the base material ( $t \geq 6\text{mm}$  [0.24"]) and ensures a proper drilling depth and an accurate bore hole in terms of diameter. The front part generates the blind pilot hole in the base material in which the self-tapping thread will be set. The step (increased diameter) prevents the drill bit from further movement and through-penetration. Furthermore, the step will create a "shiny-ring" around the hole which allows the installer to recognize the end of the drilling process.



Shiny ring around the bore hole

Each S-BT HL sales box includes the corresponding TS-BT stepped drill bit. The stepped drill bit typically resists at least 100 bore holes with a constant geometry.

Hilti recommends disposing of the used TS-BT stepped drill bit once the complete sales packaging S-BT HL studs are consumed. Hilti then advises using the new stepped drill bit out of the new sales packaging.

### 1.2.4 Installation tool

Designation	Item Description	Application
SBT 6-22	UCD tool with installation algorithm	Drilling / Setting

The SBT 6-22 cordless drill driver with installation assist fulfill the requirements for the installation process. The torque limiter trips when the stud reaches the correct screw-in depth.



SBT 6-22 drilling / setting tool

### 1.2.5 Stud holder

Designation	Item Description	Application
S-SH BT M8	Stud holder for S-BT M8	Setting
S-SH BT M10/W10	Stud holder for S-BT M10/W10	Setting

The new SBT 6-22 drill driver is equipped with special software algorithm that assists the installer in drilling the holes and screwing in the S-BT HL threaded studs.



S-SH BT stud holder

For the **drilling process** select the following settings on the SBT 6-22: Clamp the appropriate TS-BT drill bit in the keyless chuck, select forward rotation. Set the gear selector switch to 2 and BT clutch setting. Speed of the tool reduces automatically when the hole is drilled to the correct depth. A shiny ring should be visible around the borehole after the drilling process.



Hilti SBT 6-22 using "drill assist" mode.

For the **setting process** select the following settings on the SBT 6-22: Clamp the appropriate stud holder S-SH BT in the keyless chuck, select forward rotation. Set the gear selector switch to 1 and BT clutch setting. Insert the S-BT HL stud into the stud holder. The torque limiter trips when the stud reaches the correct depth.



Hilti SBT 6-22 using “fasten S-BT stud” mode.

The installer is responsible for the correct setting of the S-BT HL studs. The S-IC BT inspection card can be used to check the standoff in cases where the washer compression of the S-BT HL is assessed as incorrect (over or under compressed).

### 1.2.6 Installation temperature and service temperature

The **installation temperature** is the temperature at which the S-BT HL studs are installed. A distinction is made between the temperature of the base material and the temperature of the S-BT HL studs, drilling and installation tools and accessories. Concerning the temperature range of the drilling and setting tools see the respective operating instructions. Provided the tools are operated within their allowed range, fasteners can be installed into materials down to -40 °C base steel temperature. Condition here is, that the toughness specification of such base steels allows material use in that low temperature range. The installation temperature range can be found in the table below.

The **service temperature** is the temperature at which the S-BT HL studs operate. The S-BT HL studs will operate effectively and without any loss in performance (loads, sealing function, etc.) within the specified service temperature range. The recommended service temperature in marine atmospheres amounts between -40 °C to +60 °C. The use up to +100 °C ambient temperature is possible when the specific environmental conditions for these cases are taken into account. Those limits are determined by the sealing function of the rubber material of the sealing washer of the S-BT threaded studs. Outside this temperature range the S-BT HL studs may fail.

	Installation temperature		Service temperature	
	min	max	min	max
Base material	-40 °C	+60 °C	-40 °C	+60 °C
S-BT HL studs	-10 °C	+60 °C	-40 °C	+60 °C
Drilling & installation tools and accessories	-10 °C	+60 °C	n.a.	n.a.

**Note:**

- The service temperature range of the connected cable lugs and cables has to be observed. For details, please contact the supplier of the cable lugs and cables.
- When using Hilti S-BT HL fasteners in combination with fire rated boundaries in Shipbuilding facilities, the maximum service temperature for a period of 60 minutes is higher. For more details refer to section 4.10 “Fire resistance”.

### 1.3 Fastening mechanism

The S-BT HL fastener will be screwed in into a pre-drilled hole. The threaded stud is tapping its own internal mating threads when installed into base material. The S-BT HL fasteners are anchored in the base material by way of a keying effect, i.e. self-tapping screws form a thread in the base material. The ground cross-sections of an S-BT HL fastener in steel shows the thread of the fastener engaged with the base material.

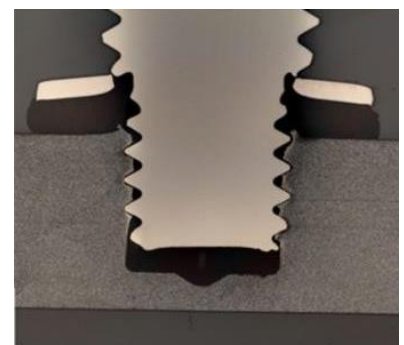

Fastening mechanism S-BT HL stud



#### 1.4 S-BT HL system features and benefits – simplified fastening to steel

##### **No rework for base material thickness $t_{II} \geq 6 \text{ mm}$ [0.24"]:**

Stud welding or through-bolting, for example, may require reworking of the protective surface coating. With the S-BT HL system, the stud is set into a small pre-drilled pilot hole. In case of a blind hole the drill entry point is then completely sealed by the stud washer during setting. If the real base material thickness  $t_{II}$  exceeds 6 mm [0.24"], no rework of the protective surface coating on the back side is needed.

##### **Simple and fast:**

A minimal amount of training is all that is required for a user to be able to install up to 100 studs per hour.

##### **High corrosion resistance:**

The stainless steel S-BT HL fasteners are made from the duplex stainless steel type 1.4462, which is equivalent to AISI 316L (A4) and 318LN steel grade and suitable for aggressive environments like in coastal and offshore applications.

The coating of the carbon steel S-BT HL fasteners consists of an electroplated Zn-alloy for cathodic protection and a top coat for chemical resistance (Duplex-coating). The use of this coating is limited to the corrosion category C1, C2 and C3 according to the standard EN ISO 9223. Refer to section 0 for selection of the suitable fastener in terms of corrosion.

##### **High tension and shear load values:**

S-BT HL delivers performance comparable to methods such as stud welding. See load data tables in section 3.2 for details.

##### **Fasten to all steel shapes:**

Unlike clamps, which are limited by the configuration of the base steel, the S-BT HL is ideal for use on hollow sections, channel sections, wide flanges and angles.

##### **Fasten to thin steel and aluminum:**

In addition to fastening to standard construction steel  $t_{II} \geq 6 \text{ mm}$  [0.24"] (blind hole), the S-BT HL can also be used to fasten to aluminum  $t_{II} \geq 6 \text{ mm}$  [0.24"] (blind hole) and  $5 \text{ mm}$  [0.20"]  $\leq t_{II} < 6 \text{ mm}$  [0.24"] (drill through hole). Furthermore, fastening in thin steel  $3 \text{ mm}$  [0.12"]  $\leq t_{II} < 6 \text{ mm}$  [0.24"] (drill through hole) is possible. In case of a drill through hole, rework of the coating on the back side of the plate / profile may be needed.

##### **Cordless and portable:**

The cordless drilling and installation tools eliminate the need for electrical cords and heavy welding equipment. All drilling and installation steps can be performed with only one cordless drill driver.



Rework



Corrosion



Loosening

## 2 APPLICATIONS

### 2.1 Grating fastening system X-FCM

**X-FCM, X-FCM-F, X-FCM-F L and X-FCM-F NG grating discs (carbon steel) for use with S-BT-GF M8/7 AN 6 HL or S-BT-GR M8/7 SN 6 HL**

**X-FCM-R, X-FCM-R HL, X-FCM-R L and X-FCM-R NG grating discs (stainless steel) for use with S-BT-GR M8/7 SN 6 HL**

A fastening system designed for attaching metal or fiberglass grating to coated steel

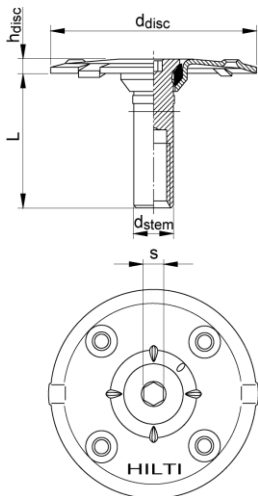

**X-FCM, X-FCM-F, X-FCM-R**  
grating discs

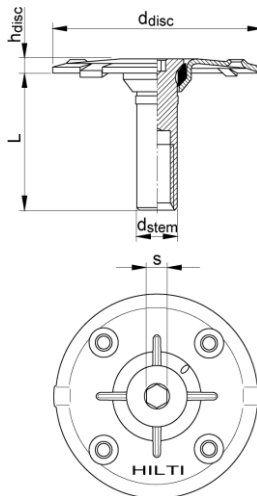

**X-FCM-R HL**  
grating disc

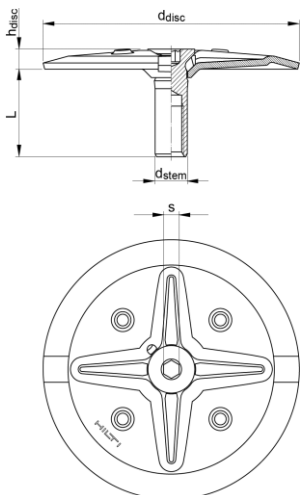

**X-FCM-F L, X-FCM-R L**  
grating discs

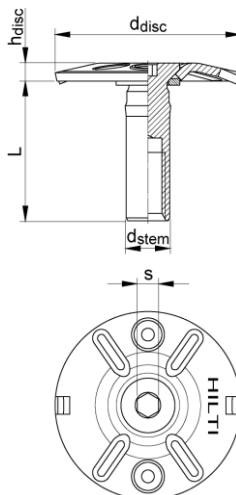

**X-FCM-F NG, X-FCM-R NG**  
grating disc

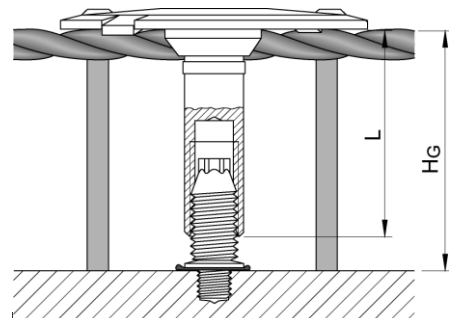
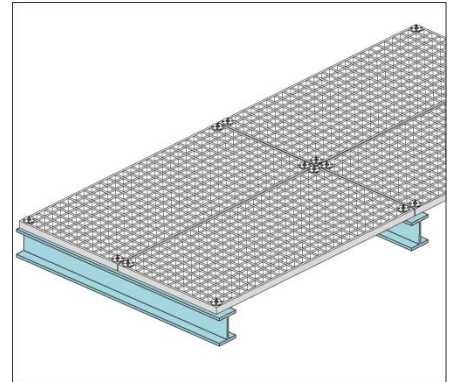

**Important:** The X-FCM, X-FCM-F, X-FCM-F L, X-FCM-F NG, X-FCM-R, X-FCM-R HL, X-FCM-R L and X-FCM-R NG systems are not designed or intended to resist shear loads.

**X-SEA-R 30 M8 and X-SEA-F 30 M8 extension adapter**

For fastening of grating with a height in excess of 53 mm [2.08"].

X-SEA-R 30 M8 for use with S-BT HL and X-FCM made of stainless steel and X-SEA-F 30 M8 for use with S-BT HL and X-FCM made of coated carbon steel.

Designation	Grating element length L [mm/in.]	Grating height HG [mm/in.]	Grating height with X-SEA-R 30 M8 [mm/in.]
X-FCM 23/28 X-FCM-F 23/28 X-FCM-F NG 23/28	18/0.71	23-28/0.91-1.10	53-58/2.08-2.28
X-FCM 28/33 X-FCM-F 28/33 X-FCM-F L 28/33 X-FCM-F NG 28/33	23/0.91	28-33/1.10-1.30	58-63/2.28-2.48
X-FCM 32/37 X-FCM-F 32/37 X-FCM-F L 32/37 X-FCM-F NG 32/37	27/1.06	32-37/1.26-1.45	62-67/2.44-2.64
X-FCM 38/43 X-FCM-F 38/43 X-FCM-F L 38/43 X-FCM-F NG 38/43	33/1.30	38-43/1.49-1.69	68-73/2.68-2.87
X-FCM 48/53 X-FCM-F 48/53 X-FCM-F L 48/53 X-FCM-F NG 48/53	43/1.69	48-53/1.89-2.08	78-83/3.07-3.27
X-FCM-R 23/28 X-FCM-R HL 23/28 X-FCM-R NG 23/28	18/0.71	23-28/0.91-1.10	53-58/2.08-2.28
X-FCM-R 28/33 X-FCM-R HL 28/33 X-FCM-R L 28/33 X-FCM-R NG 28/33	23/0.91	28-33/1.10-1.30	58-63/2.28-2.48
X-FCM-R 32/37 X-FCM-R HL 32/37 X-FCM-R L 32/37 X-FCM-R NG 32/37	27/1.06	32-37/1.26-1.45	62-67/2.44-2.64
X-FCM-R 38/43 X-FCM-R HL 38/43 X-FCM-R L 38/43 X-FCM-R NG 38/43	33/1.30	38-43/1.49-1.69	68-73/2.68-2.87
X-FCM-R 48/53 X-FCM-R HL 48/53 X-FCM-R L 48/53 X-FCM-R NG 48/53	43/1.69	48-53/1.89-2.08	78-83/3.07-3.27

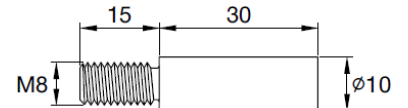

**X-SEA-R 30 M8 extension adaptor**

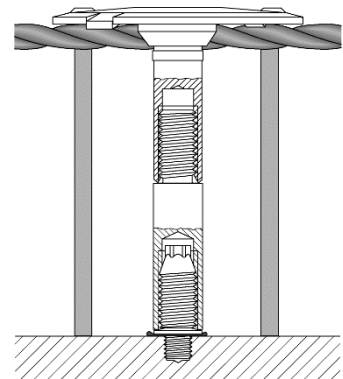

Installation instructions X-FCM

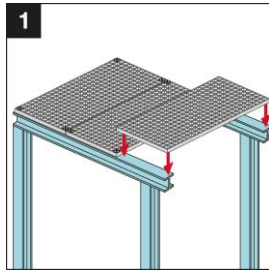

1 Lay grating section in final position.

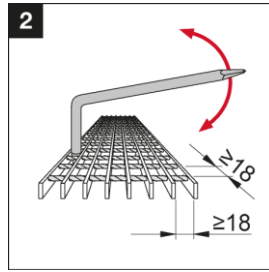

2 Expand grating openings if necessary.

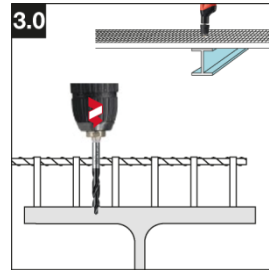

3.0 Pre-drill with **TS-BT 5.3-95 S** stepped drill bit.

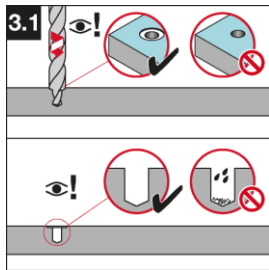

3.1 Pre-drill until shoulder grinds a shiny ring. The drilled hole and the area around drilled hole must be clean and free from liquids and debris.

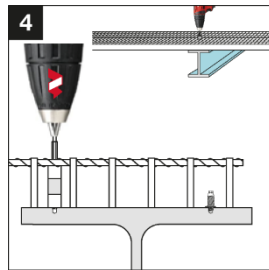

4 Screw-in S-BT HL studs into drilled hole.

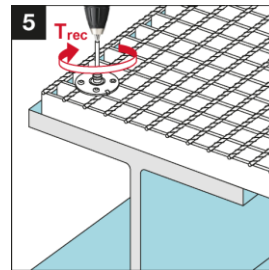

5 Tighten X-FCM discs with 5 mm Allen-type bit with the suited installation torque.

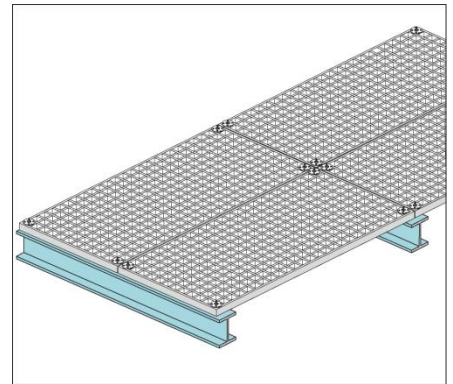

**Important notes:**

These are abbreviated instructions which may vary by application. ALWAYS review / follow the instructions for use (IFU) accompanying the product. In case of a **drill through hole**, rework of the coating on the back side of the plate / profile may be needed.

**Recommended tightening torque for tightening grating elements**

Designation	Base material	Base material thickness $t_{II}$	Tightening torque $T_{rec}$
X-FCM X-FCM-F X-FCM-F L X-FCM-R X-FCM-R L	Steel	$t_{II} \geq 3 \text{ mm [0.12" ]}$	8 Nm [5.9 lbft]
X-FCM-R HL	Steel	$3 \text{ mm [0.12" ]} \leq t_{II} < 5 \text{ mm [0.20" ]}$	8 Nm [5.9 lbft]
		$t_{II} \geq 5 \text{ mm [0.20" ]}$	16 Nm [11.8 lbft]

Installation instructions X-FCM NG

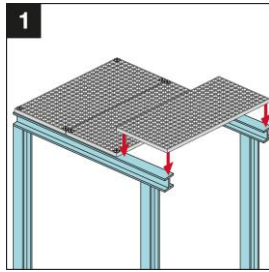

1 Lay grating section in final position.

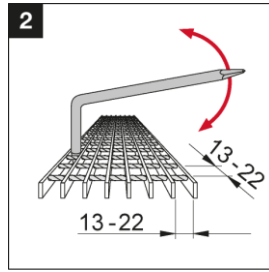

2 Expand grating openings if necessary.

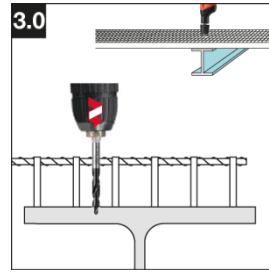

3.0 Pre-drill with **TS-BT 5.3-95 S** stepped drill bit.

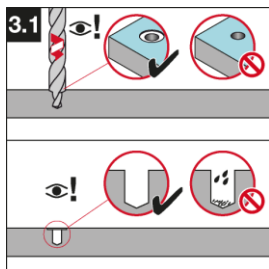
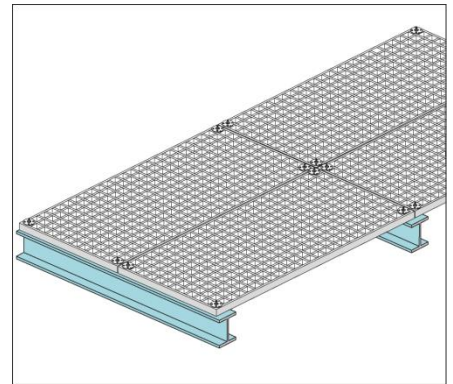

3.1 Pre-drill until shoulder grinds a shiny ring. The drilled hole and the area around drilled hole must be clean and free from liquids and debris.

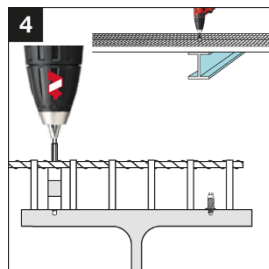

4 Screw-in S-BT HL studs into drilled hole.

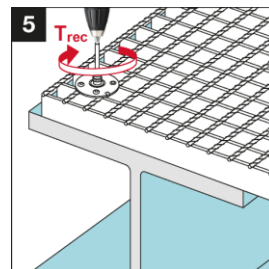

5 Tighten X-FCM NG discs with 5 mm Allen-type bit with the suited installation torque.

**Important notes:**

These are abbreviated instructions which may vary by application. ALWAYS review / follow the instructions for use (IFU) accompanying the product. In case of a **drill through hole**, rework of the coating on the back side of the plate / profile may be needed.

**Recommended tightening torque for tightening grating elements**

Designation	Base material	Base material thickness $t_{II}$	Tightening torque $T_{rec}$
X-FCM-F NG	Steel	$t_{II} \geq 3 \text{ mm [0.12" ]}$	5 Nm [3.7 lbft]
X-FCM-R NG		$t_{II} \geq 3 \text{ mm [0.12" ]}$	8 Nm [5.9 lbft]

## 2.2 Grating fastening system X-FCS-R

### X-FCS-R grating fastener for use with S-BT-GR M8/7 HL

The X-FCS-R system is a fastening system for grating fastening with tensile and shear resistance capability (shear relevant zones).

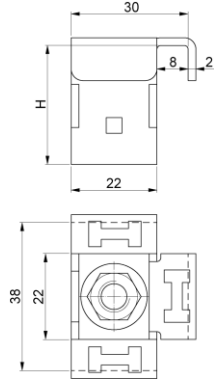

X-FCS-R-3-25 grating fastener

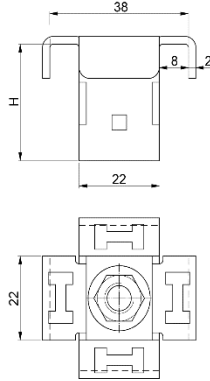

X-FCS-R-4-25 grating fastener

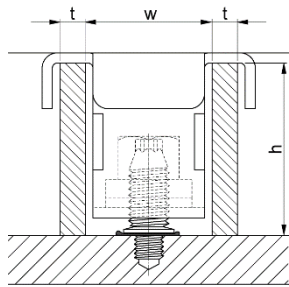
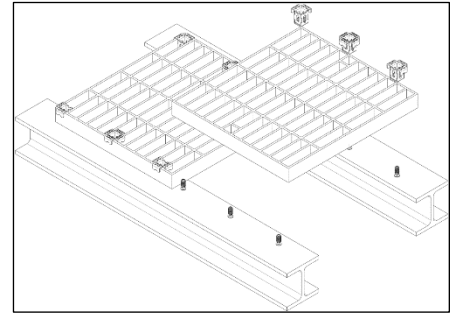

X-FCS-R-4-25 grating fastener

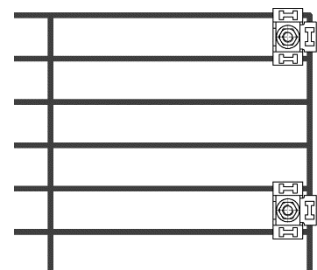
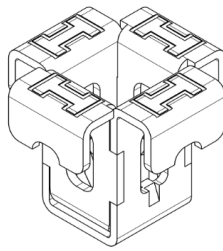

X-FCS-R-3-25 for rectangular gratings

#### Fastener Selection

Designation	Fastener height H [mm/in.]	Grating height h, range [mm/in.]
X-FCS-R-3-25 31/35	30.5/1.20	31-35/1.22-1.38
X-FCS-R-3-25 37/41	36.5/1.44	37-41/1.46-1.61
X-FCS-R-4-25 31/35	30.5/1.20	31-35/1.22-1.38
X-FCS-R-4-25 37/41	36.5/1.44	37-41/1.46-1.61

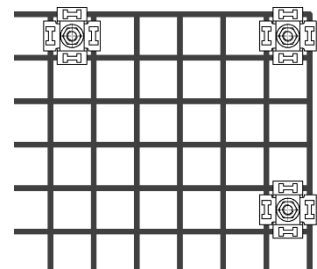

X-FCS-R-4-25 for square gratings

**Important:** The X-FCS-R system is suitable for rectangular gratings and square gratings with a bar spacing  $w = 25 \text{ mm}$  [0.98"] and bar thickness  $t = 5 \text{ mm}$  [0.20"].

#### Recommended tightening torque for tightening grating elements

Designation	Base material	Base material thickness $t_{II}$	Tightening torque $T_{rec}$
X-FCS-R	Steel	$3 \text{ mm}$ [0.12"] $\leq t_{II} < 5 \text{ mm}$ [0.20"]	8 Nm [5.9 lbf]t
		$t_{II} \geq 5 \text{ mm}$ [0.20"]	16 Nm [11.8 lbf]t

2.3 S-BT HL with MM, MQ and MT installation channel system

MM channel system for use with S-BT-MF HL or S-BT-MR HL

MQ and MT channel system for use with S-BT-MF MT M10 HL, S-BT-MF MT W10 HL or S-BT-MR HL

Installation instructions

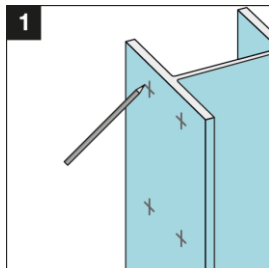

1 Mark location of each fastening.

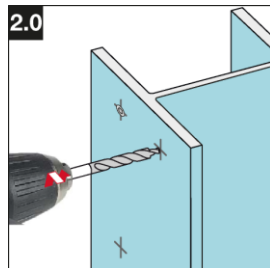

2.0 Pre-drill with **TS-BT 5.3-65 S** stepped drill bit.

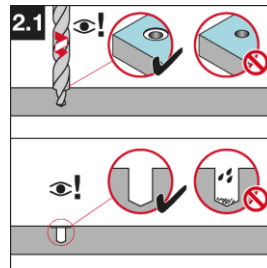

2.1 Pre-drill until shoulder grinds a shiny ring. The drilled hole and the area around drilled hole must be clean and free from liquids and debris.

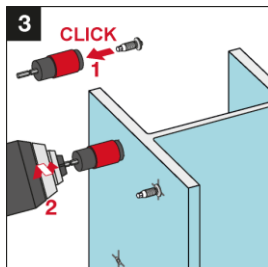
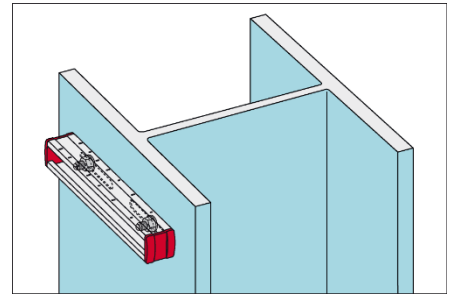

3 Screw-in S-BT HL studs into drilled hole.

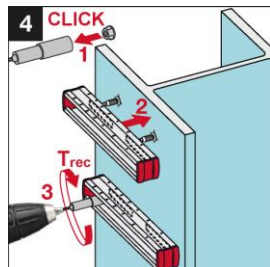

4 Position channel on S-BT HL studs and hold in place. Tighten the nuts with the suited installation torque.

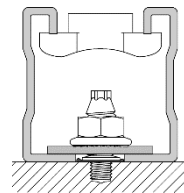

**Note:** In case of applied shear load, the S-BT HL should be placed according to illustration (end of slotted hole)

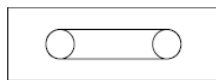

Two S-BT HL studs in one slotted hole



One S-BT HL stud in each slotted hole

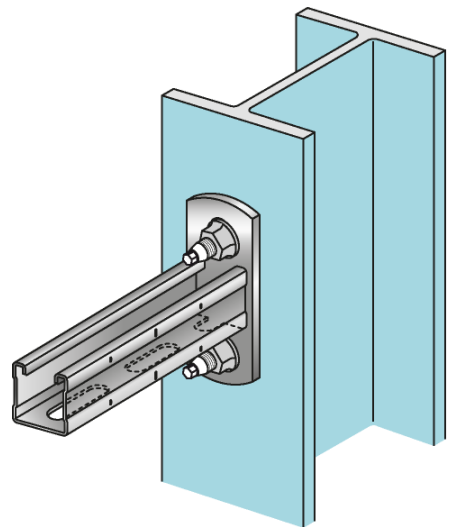

2.4 Fastening instrumentation, junction boxes and lighting

S-BT HL screw-in threaded studs for attaching instrumentation, junction boxes and lighting to coated steel

Installation instructions

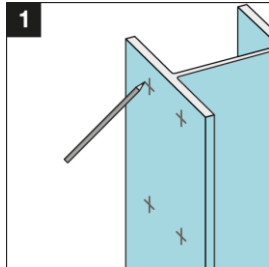

1 Mark location of each fastening.

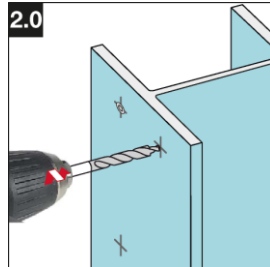

2.0 Pre-drill with **TS-BT 5.3-65 S** stepped drill bit.

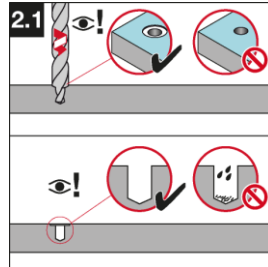

2.1 Pre-drill until shoulder grinds a shiny ring. The drilled hole and the area around drilled hole must be clean and free from liquids and debris.

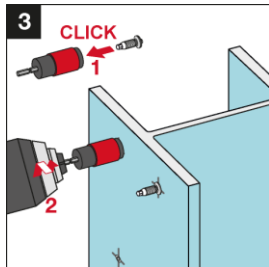

3 Screw-in S-BT HL studs into drilled hole.

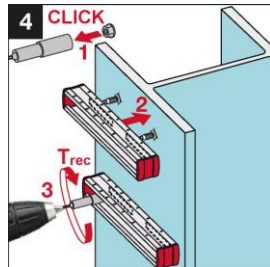

4 Position channel on S-BT HL studs and hold in place. Tighten the nuts with the suited installation torque.

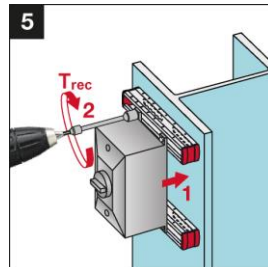

5 Fasten the accessory on the channel with the suited installation torque.

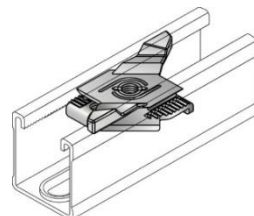
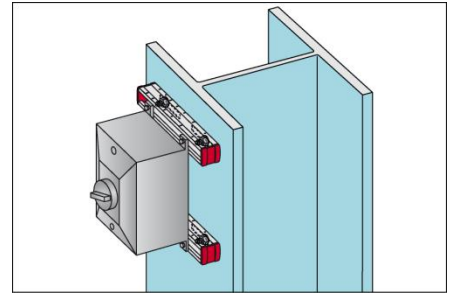

MM Channel System with wing nut M6, M8, M10

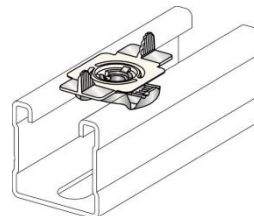

MQ Channel System with wing nut M6, M8, M10, M12, 1/4", 3/8"

For fastening the accessory on the Hilti channel or bracket always use the suitable Hilti wing nut in combination with a proper bolt. The instruction for use (IFU) accompanying the sales packaging of the Hilti wing nuts comprises detailed information about the installation of the wing nut and the tightening torque  $T_{rec}$ .

**Important notes:**

These are abbreviated instructions which may vary by application. ALWAYS review / follow the instructions for use (IFU) accompanying the product. In case of a **drill through hole**, rework of the coating on the back side of the plate / profile may be needed.



## 2.5 Fastening cable / conduit connectors

Stainless steel and carbon steel S-BT HL screw-in threaded studs for fastening cable and conduit connectors (T-bars) to coated steel.

### Installation instructions

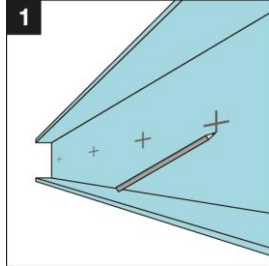

1  
Mark location of each fastening.

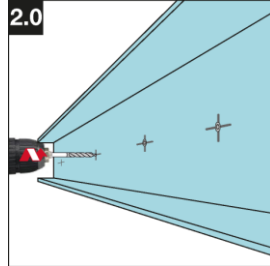

2.0  
Pre-drill with **TS-BT 5.3-65 S** stepped drill bit.

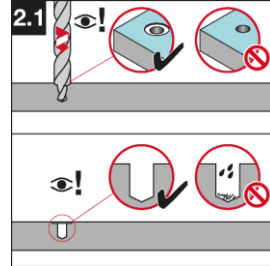

2.1  
Pre-drill until shoulder grinds a shiny ring. The drilled hole and the area around drilled hole must be clean and free from liquids and debris.

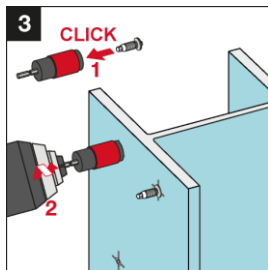
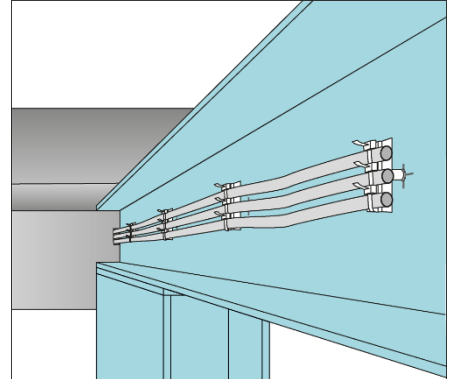

3  
Screw-in S-BT HL studs into drilled hole.

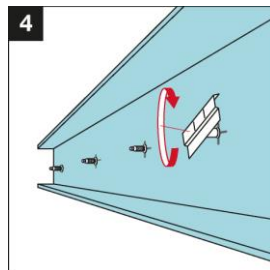

4  
Screw on the connector and hand tighten.

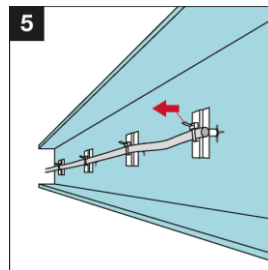

5  
Align connectors. Fasten the cable / conduit on the connector.

## 2.6 Fastening cable tray supports

Stainless steel and carbon steel S-BT HL screw-in threaded studs for fastening cable trays to coated steel.

### Installation instructions

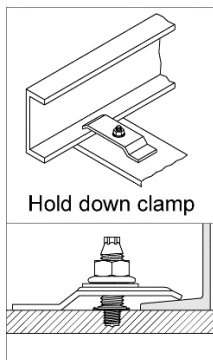

Hold down clamp

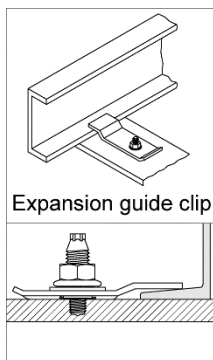

Expansion guide clip

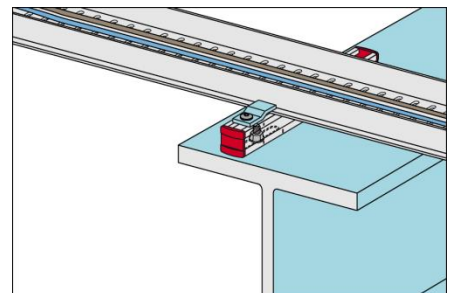
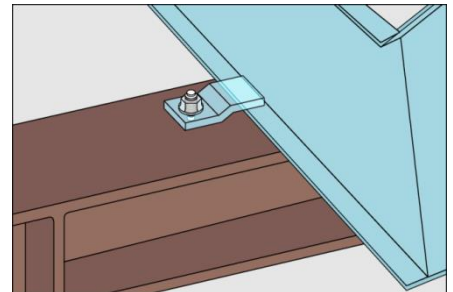

#### Important notes:

These are abbreviated instructions which may vary by application. ALWAYS review / follow the instructions for use (IFU) accompanying the product. In case of a **drill through hole**, rework of the coating on the back side of the plate / profile may be needed.

2.7 Electrical connections

	Stainless steel S-BT-ER HL	Carbon steel S-BT-EF HL
Threaded shank	○ Stainless steel S31803, AISI 318LN, (1.4462)	○ Carbon steel 1038
Washer	zinc-coated ○ SN 12-R Ø 12mm [0.47"] Stainless steel S31603, AISI 316L, (1.4404)	duplex-coated ○ AN 10-F Ø 10mm [0.39"] Aluminum EN AW-5754
Nut	○ Stainless steel grade A4 – AISI 316 material	○ Carbon steel HDG
Lock washer	○ Stainless steel grade A4 – AISI 316 material	○ Carbon steel HDG
Conductivity disc	⊙ Ø 32mm [1.260"] (HC 120 / HC 4/0) Copper alloy CuSn8 (tin-coated) with sealing ring	
Sealing ring of sealing washer	Chloroprene rubber CR 3.1107 black, resistant to UV, salt water, water, ozone, oils, etc.	
Sealing ring of Conductivity disc	FKM, resistant to UV, salt water, water, ozone, oils, etc.	

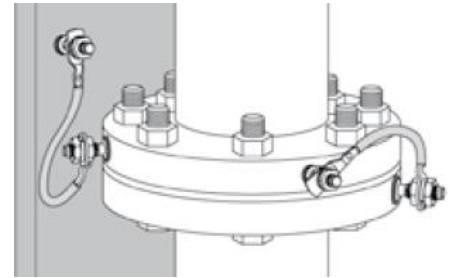

Functional and protective bonding of pipes<sup>\*)</sup> (outer diameter of installed surface ≥ 150mm)

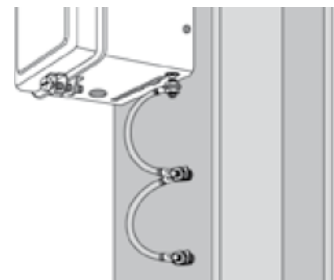

Protective bonding circuit – Double point connection

Fasteners

S-BT-ER M10/15 SN 6 HL  
S-BT-ER W10/15 SN 6 HL  
S-BT-EF M10/15 AN 6 HL  
S-BT-EF W10/15 AN 6 HL

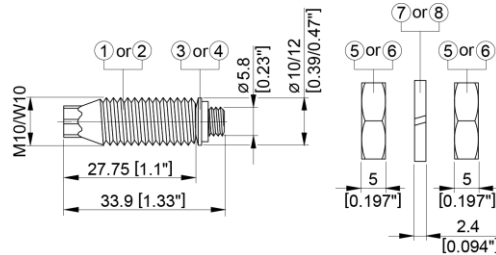

S-BT-ER M8/15 SN 6 HL  
S-BT-EF M8/15 AN 6 HL

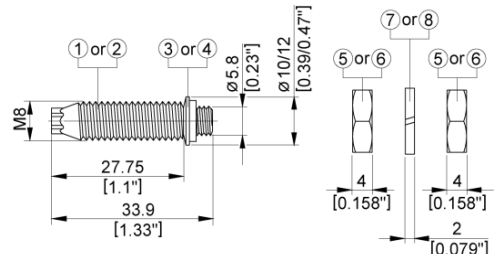

S-BT-ER M10 HC 120 HL  
S-BT-ER W10 HC 4/0 HL  
S-BT-EF M10 HC 120 HL  
S-BT-EF W10 HC 4/0 HL

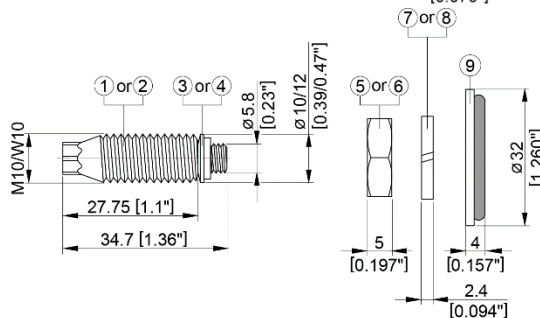

Please refer to section 4.8.1 for additional technical information with regards to the effect of S-BT-ER HL / S-BT-EF HL fasteners on integrity of pipe flange.

<sup>\*)</sup> only for Type A cable connections

### 2.7.1 Functional bonding and terminal connection in a circuit

For permanent current (leakage current) due to static charge built up in pipes or when closing an electrical circuit.

#### Single point connection:

Recommended electrical connectors:

Maximum allowable permanent current

Connection configuration

Type A connection

- S-BT-ER M10/15 SN 6 HL
- S-BT-ER W10/15 SN 6 HL
- S-BT-EF M10/15 AN 6 HL
- S-BT-EF W10/15 AN 6 HL
- S-BT-ER M8/15 SN 6 HL
- S-BT-EF M8/15 AN 6 HL

$I_{th} = 57 \text{ A}$

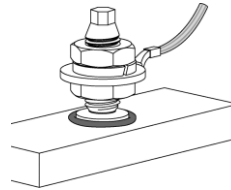

Type A connection

- with Hilti standoff Adapter M8-MR, M10-MR, W10-MR
- S-BT-ER M8/15 SN 6 HL
- S-BT-ER M10/15 SN 6 HL
- S-BT-ER W10/15 SN 6 HL

$I_{th} = 57 \text{ A}$

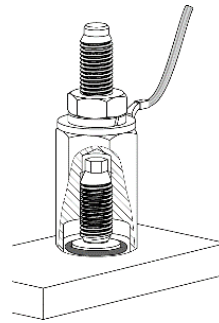

Type A connection

- with Hilti standoff Adapter M10-HC120, W10-HC4/0
- S-BT-ER M10/15 SN 6 HL
- S-BT-ER W10/15 SN 6 HL

$I_{th} = 269 \text{ A}$

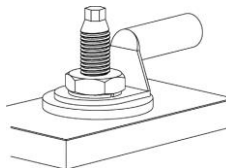

Type B connection

- S-BT-ER M10 HC 120 HL
- S-BT-ER W10 HC 4/0 HL
- S-BT-EF M10 HC 120 HL
- S-BT-EF W10 HC 4/0 HL

$I_{th} = 269 \text{ A}$

#### Note:

- Recommended maximal cross section of connected cable according IEC 60947-7-2 and IEC 60947-7-1:  
 10 mm<sup>2</sup> (8 AWG) copper (tested permanent current  $I_{th} = 57 \text{ A}$ )  
 120 mm<sup>2</sup> (4/0 AWG) copper (tested permanent current  $I_{th} = 269 \text{ A}$ )
- Fastening of thicker cable is acceptable, if the maximum allowable permanent current  $I_{th}$  is not exceeded and the provisions on cable lug thickness  $t_{cl}$  are observed.

### 2.7.2 Protective bonding circuit

For discharging short circuit current while protecting electrical equipment or earth / ground cable trays and ladders.

#### Single point connection:

Recommended electrical connectors:

Type A connection

S-BT-ER M10/15 SN 6 HL  
 S-BT-ER W10/15 SN 6 HL  
 S-BT-EF M10/15 AN 6 HL  
 S-BT-EF W10/15 AN 6 HL  
 S-BT-ER M8/15 SN 6 HL  
 S-BT-EF M8/15 AN 6 HL

Max. short circuit current according to IEC and UL

$I_{cw} = 1.20 \text{ kA (IEC)}$   
 $I_{cw} = 0.75 \text{ kA (UL)}$

Connection configuration

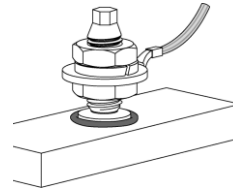

Type A connection

with Hilti standoff Adapter M8-MR, M10 MR, W10 MR  
 S-BT-ER M8/15 SN 6 HL  
 S-BT-ER M10/15 SN 6 HL  
 S-BT-ER W10/15 SN 6 HL

$I_{cw} = 1.20 \text{ kA (IEC)}$   
 $I_{cw} = 0.75 \text{ kA (UL)}$

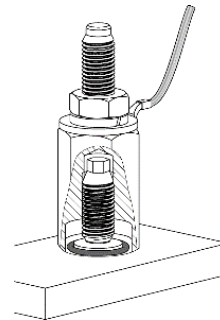

Type A connection with Hilti standoff Adapter M10-HC120, W10-HC4/0  
 S-BT-ER M10/15 SN 6 HL  
 S-BT-ER W10/15 SN 6 HL

$I_{cw} = 14.40 \text{ kA (IEC)}$   
 $I_{cw} = 10.10 \text{ kA (UL)}$

Type B connection

S-BT-ER M10 HC 120 HL  
 S-BT-ER W10 HC 4/0 HL  
 S-BT-EF M10 HC 120 HL  
 S-BT-EF W10 HC 4/0 HL

$I_{cw} = 14.40 \text{ kA (IEC)}$   
 $I_{cw} = 10.10 \text{ kA (UL)}$

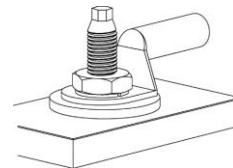

#### Note:

- Recommended maximal cross section of connected cable according **IEC 60947-7-2 and IEC 60947-7-1**:  
 10 mm<sup>2</sup> (8 AWG) copper (tested short circuit current  $I_{cw} = 1.20 \text{ kA}$  for 1 s)  
 120 mm<sup>2</sup> (4/0 AWG) copper (tested short circuit current  $I_{cw} = 14.40 \text{ kA}$  for 1 s)  
 according **UL 467**:  
 10 AWG copper (tested short circuit current  $I_{cw} = 0.75 \text{ kA}$  for 4 s)  
 4/0 AWG copper (tested short circuit current  $I_{cw} = 10.10 \text{ kA}$  for 9 s)
- Fastening of thicker cable is acceptable, if the maximum short circuit current  $I_{cw}$  and the exposure time is not exceeded and the provisions on cable lug thickness  $t_{cl}$  are observed.

**Double point connection:**

Recommended electrical connectors:

Type A connection

- S-BT-ER M10/15 SN 6 HL
- S-BT-ER W10/15 SN 6 HL
- S-BT-EF M10/15 AN 6 HL
- S-BT-EF W10/15 AN 6 HL
- S-BT-ER M8/15 SN 6 HL
- S-BT-EF M8/15 AN 6 HL

Max. short circuit current according to IEC

$I_{cw} = 1.92 \text{ kA (IEC)}$

Connection configuration

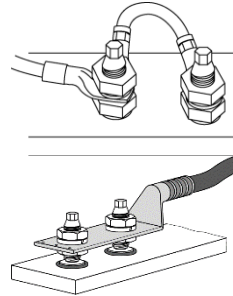

**Note:**

- Recommended maximal cross section of connected cable according **IEC 60947-7-2 and IEC 60947-7-1**:  
16 mm<sup>2</sup> (6 AWG) copper (tested short circuit current  $I_{cw} = 1.92 \text{ kA}$  for 1 s)
- Fastening of thicker cable is acceptable, if the maximum short circuit current  $I_{cw}$  and the exposure time is not exceeded and the provisions on cable lug thickness  $t_{cl}$  are observed.

### 2.7.3 Lightning protection

For high temporary current due to lightning.

#### Single point connection.

Classification acc. IEC 62561-1:2023-03 (Edition 3.0):

- **Class N** for normal duty
- Connection configuration: B4 – T connector
- Including permanent and non-permanent connections
- Installation location<sup>\*)</sup>:  
S-BT-ER: a, b, c, d, e  
S-BT-EF: b, d, e
- Not intended to withstand a static mechanical stress

Recommended electrical connectors:

S-BT-ER M10/15 SN 6 HL  
S-BT-ER W10/15 SN 6 HL  
S-BT-EF M10/15 AN 6 HL  
S-BT-EF W10/15 AN 6 HL  
S-BT-ER M8/15 SN 6 HL  
S-BT-EF M8/15 AN 6 HL

S-BT-ER M8/15 SN 6 HL  
with Hilti standoff adapter  
M8-MR

S-BT-ER M10/15 SN 6 HL  
with Hilti standoff adapter  
M10-MR

S-BT-ER W10/15 SN 6 HL  
with Hilti standoff adapter  
W10-MR

Maximum lightning current

$I_{imp} = 50 \text{ kA}$  for  $\leq 5 \text{ ms}$   
(according to IEC 62561-1)

$I_{imp} = 50 \text{ kA}$  for  $\leq 5 \text{ ms}$   
(according to IEC 62561-1)

Connection configuration

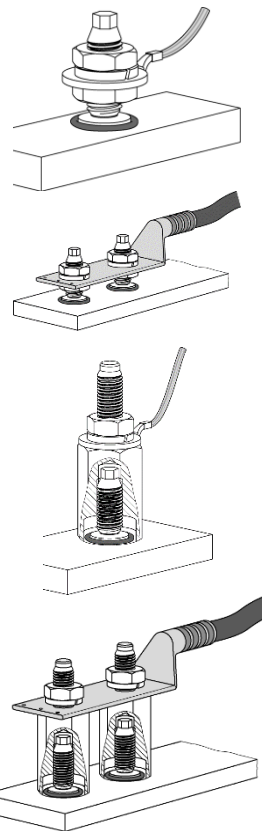

<sup>\*)</sup> Installation location:

a) outdoors; b) indoors; c) buried in ground; d) embedded in concrete; e) embedded in materials with thermal insulation

#### Important notes:

For the connection type "Single point connection with adapter" the adapter must be in direct contact with non-coated base material. Coating has to be removed with the TS-BT 5.3 HC 95 coating removal drill bit.

**Single point connection.**

**Classification acc. IEC 62561-1:2023-03 (Edition 3.0):**

- **Class H** for heavy duty
- Connection configuration: B4 – T connector
- Including permanent and non-permanent connections
- Installation location<sup>\*)</sup>:  
S-BT-ER: a, b, c, d, e  
S-BT-EF: b, d, e
- Not intended to withstand a static mechanical stress

Recommended electrical connectors:

Maximum lightning current

Connection configuration

S-BT-ER M10 HC 120 HL  
S-BT-ER W10 HC 4/0 HL  
S-BT-EF M10 HC 120 HL  
S-BT-EF W10 HC 4/0 HL

$i_{imp} = 100 \text{ kA}$  for  $\leq 5 \text{ ms}$   
(according to IEC 62561-1)

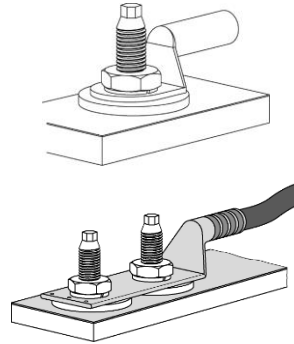

S-BT-ER M10/15 SN 6 HL with Hilti standoff adapter M10-HC120  
S-BT-ER W10/15 SN 6 HL with Hilti standoff adapter W10-HC4/0

$i_{imp} = 100 \text{ kA}$  for  $\leq 5 \text{ ms}$   
(according to IEC 62561-1)

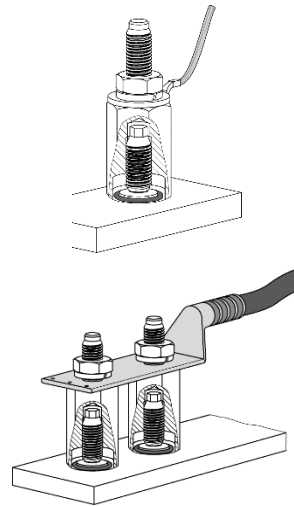

<sup>\*)</sup> Installation location:

a) outdoors; b) indoors; c) buried in ground; d) embedded in concrete; e) embedded in materials with thermal insulation

**Important notes:**

For both connection types the conductivity disc or the adapter must be in direct contact with non-coated base material. Coating has to be removed with the TS-BT 5.3 HC 95 coating removal drill bit.

### 3 TECHNICAL DATA

#### 3.1 Product data

##### 3.1.1 S-BT HL material specifications and dimensions

	<b>Stainless steel</b>	<b>Carbon steel</b>
	<b>S-BT-MR HL</b>	<b>S-BT-MF HL</b>
	<b>S-BT-GR HL</b>	<b>S-BT-GF HL</b>
Threaded shank	① Stainless steel S31803, (1.4462) zinc-coated	② Carbon steel 1038 duplex-coated
Washer	③ SN 12-R Ø 12mm [0.47"]	④ AN 10-F Ø 10mm [0.39"] or Ø 12mm [0.47"] ***)
Serrated flange nut	Stainless steel S31603 (1.4404) ⑤ Stainless steel grade A4-70/80	Aluminum (EN AW-5754) ⑥ Carbon steel HDG, grade 8
Sealing washer	③ or ④ Chloroprene rubber CR 3.1107, black, resistant to UV, salt water, water, ozone, oils, etc.	

- S-BT-MR M10/15 SN 6 HL
- S-BT-MR W10/15 SN 6 HL
- S-BT-MR M10/15 SN 6 HL AL\*\*)
- S-BT-MR W10/15 SN 6 HL AL\*\*)
- S-BT-MF M10/15 AN 6 HL
- S-BT-MF MT M10/15 AN 6 HL\*\*\*)
- S-BT-MF W10/15 AN 6 HL
- S-BT-MF MT W10/15 AN 6 HL\*\*\*)

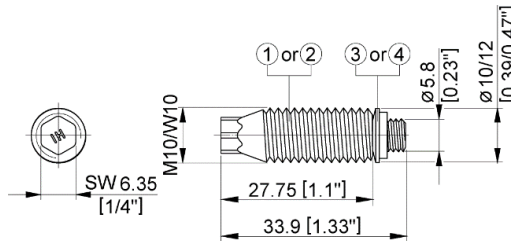

- S-BT-MR M8/7 SN 6 HL
- S-BT-MR M8/7 SN 6 HL AL\*\*)
- S-BT-GR M8/7 SN 6 HL\*)
- S-BT-GR M8/7 SN 6 HL AL\*\*\*)
- S-BT-MF M8/7 AN 6 HL
- S-BT-GF M8/7 AN 6 HL\*)

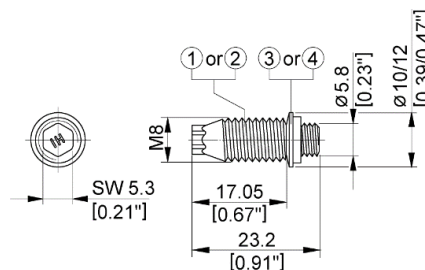

- S-BT-MR M8/15 SN 6 HL
- S-BT-MR M8/15 SN 6 HL AL\*\*)
- S-BT-MF M8/15 AN 6 HL

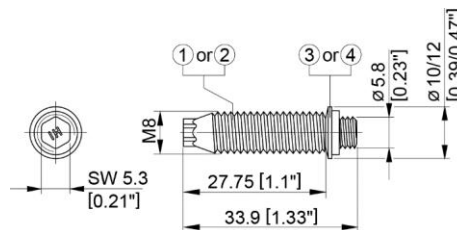

\*) Package does not include serrated flange nuts  
 \*\*) for use in aluminum base material  
 \*\*\*) S-BT-MF MT studs are equipped with a Ø 12mm [0.47"] aluminum washer

#### Serrated flange nut

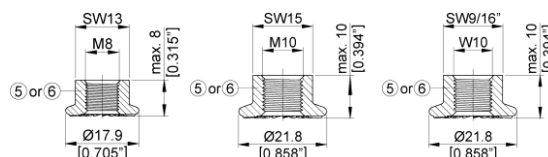



### 3.1.2 Hilti Coupler material specifications and dimensions

	<b>Stainless steel</b>	<b>Carbon steel</b>
	<b>MR M8, MR M10</b>	<b>MF M8, MF M10</b>
Hilti Coupler	Stainless steel (X5CrNiMo17-12-2) 1.4401-AISI 316 or (X2CrNiMo17-12-2) 1.4404-AISI 316L	Carbon steel (11SMnPb37+C) duplex-coated

RC-MF-M8  
RC-MR-M8

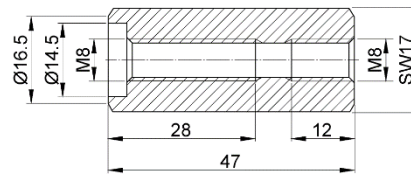

RC-MF-M10  
RC-MR-M10

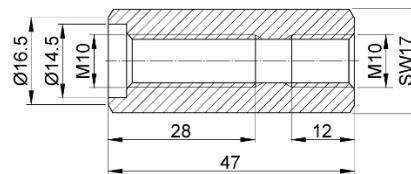

### 3.1.3 Standoff adapter material specifications and dimensions

	<b>Stainless steel</b>	<b>Carbon steel</b>
	<b>MR 25/50/75/100</b>	<b>MF 25/50/75/100</b>
Adapter	① Stainless steel (X5CrNiMo17-12-2) 1.4401-AISI 316	② Carbon steel (11SMnPb37+C) duplex-coated

Adapter M8-MR 25  
Adapter M8-MR 50  
Adapter M8-MR 75  
Adapter M8-MR 100  
Adapter M8-MF 25  
Adapter M8-MF 50  
Adapter M8-MF 75  
Adapter M8-MF 100

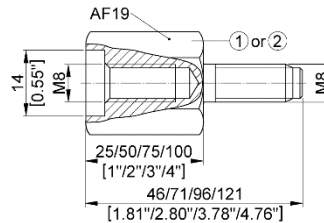

Adapter M10-MR 50  
Adapter M10-MR 75  
Adapter M10-MR 100  
Adapter M10-MF 50  
Adapter W10-MR 50  
Adapter W10-MR 75  
Adapter W10-MR 100  
Adapter W10-MF 50

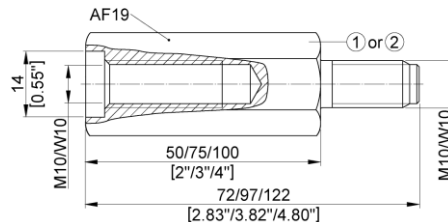

**3.1.4 S-BT HL material properties**

	<b>Stainless steel</b>	<b>Carbon steel</b>
	S-BT-MR S-BT-GR S-BT-ER	S-BT-MF S-BT-GF S-BT-EF
<b>Thermal conductivity <math>\lambda</math></b>	18,9 W/(m•K)	56,7 W/(m•K)
<b>Specific heat capacity <math>c_p</math></b>	550 J/(kg•K)	524 J/(kg•K)
<b>Electrical conductivity <math>\sigma</math></b>	1,24•10 <sup>6</sup> S/m	5,16•10 <sup>6</sup> S/m

**3.1.5 Drilling tool, setting tool, accessories and inserts**

For more details refer to section 3.2.14 “Fastener selection and system recommendation”.

**Approvals and Listings:**

EOTA: ETA-23/0001, ICC-ES: ESR-4185, ABS: 23-2361769-PDA,  
 DNV: TAS00003NW, LR: 23161857TA, BV: 74271/A0 BV,  
 RINA: FPE035023CS/001



For the S-BT HL fastening system Hilti has applied for several Type Approvals internationally valid for the ship-building and off-shore industry. These approvals will be issued by international classification bodies relevant for these industries.

These bodies are:

- ABS - American Bureau of Shipping
- DNV - Det Norske Veritas
- LR – Lloyd’s Register
- BV - Bureau Veritas
- RINA Services S.p.A.

The UL-listing (File E257069) addresses the use of S-BT-ER HL / -EF HL, S-BT-ER HC HL / -EF HC HL and X-BT-ER as grounding and bonding equipment.

The ETA-23/0001 and ESR-4185 address the use of S-BT-MR HL / -MF HL and S-BT-GR HL / -GF HL for on-shore and industry applications.

Approvals are subject to continuous changes related to code developments, product portfolio updates and new research results. Current approvals can be downloaded from Hilti website or from the websites of most Certification Bodies.

3.2 Load data

3.2.1 Recommended loads

S-BT-MR HL / S-BT-GR HL made of stainless steel					
Base material thickness	$t_{II} \geq 5 \text{ mm}$ $t_{II} \geq 0.20''$			$3 \text{ mm} \leq t_{II} < 5 \text{ mm}$ $0.12'' \leq t_{II} < 0.20 \text{ mm}$	
Base material type	<b>Steel</b> S235 A36	<b>Steel</b> S355 to S500 Grade 50	<b>Aluminum</b> $R_m \geq 270$ N/mm <sup>2</sup>	<b>Steel</b> S235 A36	<b>Steel</b> S355 to S500 Grade 50
Tension, $N_{rec}$ [kN/lb]	3.6 / 810	4.3 / 970	2.1 / 470	2.3 / 520	2.8 / 625
Shear, $V_{rec}$ [kN/lb] For edge distance $c \geq 6 \text{ mm}$ [0.24"]	4.1 / 920		3.0 / 675	4.0 / 895	
Moment, $M_{rec}$ [Nm/lbft]	11.1 / 8.0				

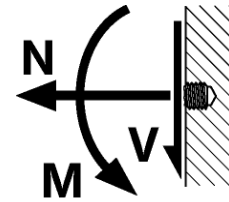

S-BT-MF HL / S-BT-GF HL made of duplex-coated carbon steel					
Base material thickness	$t_{II} \geq 5 \text{ mm}$ $t_{II} \geq 0.20''$			$3 \text{ mm} \leq t_{II} < 5 \text{ mm}$ $0.12'' \leq t_{II} < 0.20 \text{ mm}$	
Base material type	<b>Steel</b> S235 A36	<b>Steel</b> S355 to S500 Grade 50	<b>Aluminum</b> $R_m \geq 270$ N/mm <sup>2</sup>	<b>Steel</b> S235 A36	<b>Steel</b> S355 to S500 Grade 50
Tension, $N_{rec}$ [kN/lb]	4.0 / 900	4.8 / 1080	n.a.	2.3 / 520	2.8 / 625
Shear, $V_{rec}$ [kN/lb] For edge distance $c \geq 6 \text{ mm}$ [0.24"]	2.8 / 625		n.a.	2.8 / 625	
Moment, $M_{rec}$ [Nm/lbft]	6.7 / 5.0		n.a.	6.7 / 5.0	

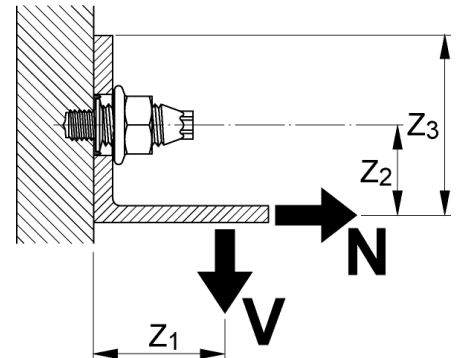

S-BT-MF MT M10/15 (W10/15) AN 6 HL made of duplex coated carbon steel					
Base material thickness	$t_{II} \geq 5 \text{ mm}$ $t_{II} \geq 0.20''$			$3 \text{ mm} \leq t_{II} < 5 \text{ mm}$ $0.12'' \leq t_{II} < 0.20 \text{ mm}$	
Base material type	<b>Steel</b> S235 A36	<b>Steel</b> S355 to S500 Grade 50	<b>Aluminum</b> $R_m \geq 270$ N/mm <sup>2</sup>	<b>Steel</b> S235 A36	<b>Steel</b> S355 to S500 Grade 50
Tension, $N_{rec}$ [kN/lb]	4.0 / 900	4.8 / 1080	n.a.	2.3 / 520	2.8 / 625
Shear, $V_{rec}$ [kN/lb] For edge distance $c \geq 6 \text{ mm}$ [0.24"]	4.0 / 900		n.a.	4.0 / 900	
Moment, $M_{rec}$ [Nm/lbft]	6.7 / 5.0		n.a.	6.7 / 5.0	

**3.2.2 Design loads**

S-BT-MR HL / S-BT-GR HL made of stainless steel					
Base material thickness	$t_{II} \geq 5 \text{ mm}$ $t_{II} \geq 0.20''$			$3 \text{ mm} \leq t_{II} < 5 \text{ mm}$ $0.12'' \leq t_{II} < 0.20 \text{ mm}$	
Base material type	<b>Steel</b> S235 A36	<b>Steel</b> S355 to S500 Grade 50	<b>Aluminum</b> $R_m \geq 270$ N/mm <sup>2</sup>	<b>Steel</b> S235 A36	<b>Steel</b> S355 to S500 Grade 50
Tension, $N_{Rd}$ [kN/lb]	5.1 / 1145	6.1 / 1370	3.0 / 670	3.3 / 740	3.9 / 875
Shear, $V_{Rd}$ [kN/lb] For edge distance $c \geq 6 \text{ mm}$ [0.24"]	5.7 / 1280		4.2 / 940	5.6 / 1255	
Moment, $M_{Rd}$ [Nm/lbft]	15.6 / 12.0				

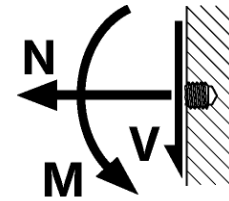

S-BT-MF HL / S-BT-GF HL made of duplex-coated carbon steel					
Base material thickness	$t_{II} \geq 5 \text{ mm}$ $t_{II} \geq 0.20''$			$3 \text{ mm} \leq t_{II} < 5 \text{ mm}$ $0.12'' \leq t_{II} < 0.20 \text{ mm}$	
Base material type	<b>Steel</b> S235 A36	<b>Steel</b> S355 to S500 Grade 50	<b>Aluminum</b> $R_m \geq 270$ N/mm <sup>2</sup>	<b>Steel</b> S235 A36	<b>Steel</b> S355 to S500 Grade 50
Tension, $N_{Rd}$ [kN/lb]	5.7 / 1280	6.8 / 1525	n.a.	3.3 / 740	3.9 / 875
Shear, $V_{Rd}$ [kN/lb] For edge distance $c \geq 6 \text{ mm}$ [0.24"]	3.9 / 875		n.a.	3.9 / 875	
Moment, $M_{Rd}$ [Nm/lbft]	9.4 / 7.0		n.a.	9.4 / 7.0	

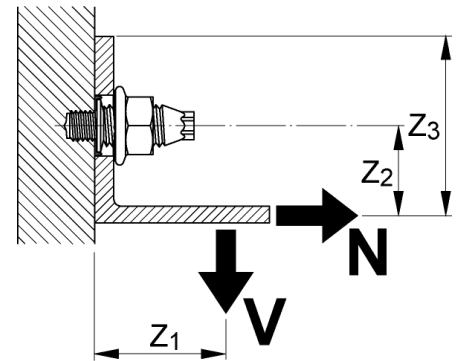

S-BT-MF MT M10/15 (W10/15) AN 6 HL made of duplex coated carbon steel					
Base material thickness	$t_{II} \geq 5 \text{ mm}$ $t_{II} \geq 0.20''$			$3 \text{ mm} \leq t_{II} < 5 \text{ mm}$ $0.12'' \leq t_{II} < 0.20 \text{ mm}$	
Base material type	<b>Steel</b> S235 A36	<b>Steel</b> S355 to S500 Grade 50	<b>Aluminum</b> $R_m \geq 270$ N/mm <sup>2</sup>	<b>Steel</b> S235 A36	<b>Steel</b> S355 to S500 Grade 50
Tension, $N_{Rd}$ [kN/lb]	5.7 / 1280	6.8 / 1525	n.a.	3.3 / 740	3.9 / 875
Shear, $V_{Rd}$ [kN/lb] For edge distance $c \geq 6 \text{ mm}$ [0.24"]	5.6 / 1255		n.a.	5.6 / 1255	
Moment, $M_{Rd}$ [Nm/lbft]	9.4 / 7.0		n.a.	9.4 / 7.0	

**Conditions for recommended loads and design loads:**

- Use S-BT-MR HL and S-BT-MF HL (multipurpose fastening) only with the supplied Hilti serrated flange nuts M8, M10, W10 (⊕ or ⊗ refer to section 3.1.1)
- The design resistance can be used for the design according the partial safety concept, e.g. EN 1993-1-1 (Eurocode 3).
- Global factor of safety  $\Omega$  resp. partial factor of safety  $\gamma_m$  (based on 5% fractile ultimate test value)

	Recommended loads	Design loads
static pull-out	2.80	2.00
static shear	2.80	2.00
Bending	1.75	1.25
- Minimum edge distance = 6 mm [0.24"], min. spacing  $\geq 18 \text{ mm}$  [0.709"]
- Effect of base metal vibration and stress (e.g. areas with tensile stress) considered.
- Redundancy (multiple fastening) must be provided.
- If eccentric loading exists (e.g. use of an angle clip), moments caused by off-center loading must be considered.

**Cyclic loading:**

S-BT HL threaded studs are only to be used for fastenings subject to static or quasi-static loading. Inquire at Hilti for test data if cyclic loading has to be considered in the design.

**3.2.3 Recommended loads S-BT HL with Hilti standoff adapter**

	<b>S-BT-MR HL / S-BT-GR HL with standoff adapter made of stainless steel</b>			
Base material thickness	$t_{fl} \geq 5 \text{ mm [0.20" ]}$	$t_{fl} = 4 \text{ mm [0.16" ]}$	$t_{fl} = 3 \text{ mm [0.12" ]}$	
Base material type	<b>Steel</b> S235 A36	<b>Steel</b> S355 to S500 Grade 50	<b>Steel<sup>1)</sup></b> S235 A36	<b>Steel<sup>1)</sup></b> S235 A36
Tension, $N_{rec}$ [kN/lb] Standoff Adapter 25, 50, 75, 100 mm	3.60 / 810	4.30 / 970	2.30 / 520	2.30 / 520
Shear, $V_{rec}$ [kN/lb] Standoff Adapter 25 mm	0.84 / 190	1.00 / 225	0.69 / 155	0.55 / 125
Shear, $V_{rec}$ [kN/lb] Standoff Adapter 50 mm	0.45 / 100	0.54 / 120	0.38 / 85	0.31 / 70
Shear, $V_{rec}$ [kN/lb] Standoff Adapter 75 mm	0.33 / 75	0.40 / 90	0.28 / 60	0.24 / 55
Shear, $V_{rec}$ [kN/lb] Standoff Adapter 100 mm	0.23 / 50	0.28 / 60	0.19 / 40	0.18 / 40

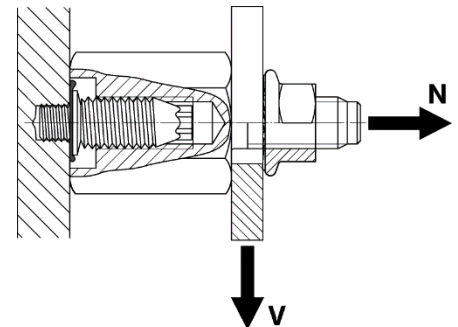

	<b>S-BT-MF HL / S-BT-MF MT HL / S-BT-GF HL with standoff adapter made of duplex coated carbon steel</b>			
Base material thickness	$t_{fl} \geq 5 \text{ mm [0.20" ]}$	$t_{fl} = 4 \text{ mm [0.16" ]}$	$t_{fl} = 3 \text{ mm [0.12" ]}$	
Base material type	<b>Steel</b> S235 A36	<b>Steel</b> S355 to S500 Grade 50	<b>Steel<sup>1)</sup></b> S235 A36	<b>Steel<sup>1)</sup></b> S235 A36
Tension, $N_{rec}$ [kN/lb] Standoff Adapter 25, 50, 75, 100 mm	4.0 / 900	4.8 / 1080	2.30 / 520	2.30 / 520
Shear, $V_{rec}$ [kN/lb] Standoff Adapter 25 mm	0.84 / 190	1.00 / 225	0.69 / 155	0.55 / 125
Shear, $V_{rec}$ [kN/lb] Standoff Adapter 50 mm	0.45 / 100	0.54 / 120	0.38 / 85	0.31 / 70
Shear, $V_{rec}$ [kN/lb] Standoff Adapter 75 mm	0.33 / 75	0.40 / 90	0.28 / 60	0.24 / 55
Shear, $V_{rec}$ [kN/lb] Standoff Adapter 100 mm	0.23 / 50	0.28 / 60	0.19 / 40	0.18 / 40

<sup>1)</sup> For steel base material of grade S355 to S500, AH36, DH36, EH36 the values are allowed to be increased up to 20%

3.2.4 Design loads S-BT HL with Hilti standoff adapter

S-BT-MR HL / S-BT-GR HL with standoff adapter made of stainless steel				
Base material thickness	$t_{fl} \geq 5 \text{ mm [0.20"]}$		$t_{fl} = 4 \text{ mm [0.16"]}$	$t_{fl} = 3 \text{ mm [0.12"]}$
Base material type	Steel S235 A36	Steel S355 to S500 Grade 50	Steel <sup>1)</sup> S235 A36	Steel <sup>1)</sup> S235 A36
Tension, $N_{Rd}$ [kN/lb] Standoff Adapter 25, 50, 75, 100 mm	5.1 / 1145	6.1 / 1370	3.3 / 740	3.3 / 740
Shear, $V_{Rd}$ [kN/lb] Standoff Adapter 25 mm	1.17 / 260	1.41 / 315	0.96 / 215	0.77 / 170
Shear, $V_{Rd}$ [kN/lb] Standoff Adapter 50 mm	0.64 / 140	0.76 / 170	0.53 / 120	0.43 / 95
Shear, $V_{Rd}$ [kN/lb] Standoff Adapter 75 mm	0.47 / 105	0.55 / 125	0.39 / 90	0.34 / 75
Shear, $V_{Rd}$ [kN/lb] Standoff Adapter 100 mm	0.32 / 70	0.39 / 90	0.27 / 60	0.25 / 55

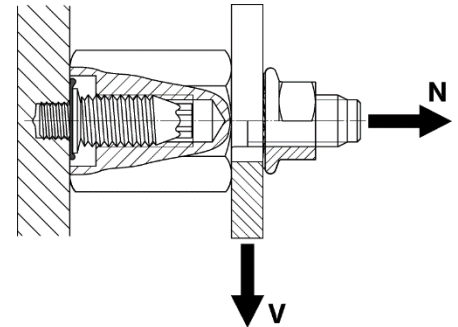

S-BT-MF HL / S-BT-MF MT HL / S-BT-GF HL with standoff adapter made of duplex coated carbon steel				
Base material thickness	$t_{fl} \geq 5 \text{ mm [0.20"]}$		$t_{fl} = 4 \text{ mm [0.16"]}$	$t_{fl} = 3 \text{ mm [0.12"]}$
Base material type	Steel S235 A36	Steel S355, S420 Grade 50	Steel <sup>1)</sup> S235 A36	Steel <sup>1)</sup> S235 A36
Tension, $N_{Rd}$ [kN/lb] Standoff Adapter 25, 50, 75, 100 mm	5.7 / 1280	6.8 / 1525	3.3 / 740	3.3 / 740
Shear, $V_{Rd}$ [kN/lb] Standoff Adapter 25 mm	1.17 / 260	1.41 / 315	0.96 / 215	0.77 / 170
Shear, $V_{Rd}$ [kN/lb] Standoff Adapter 50 mm	0.64 / 140	0.76 / 170	0.53 / 120	0.43 / 95
Shear, $V_{Rd}$ [kN/lb] Standoff Adapter 75 mm	0.47 / 105	0.55 / 125	0.39 / 90	0.34 / 75
Shear, $V_{Rd}$ [kN/lb] Standoff Adapter 100 mm	0.32 / 70	0.39 / 90	0.27 / 60	0.25 / 55

<sup>1)</sup> For steel base material of grade S355 to S500, AH36, DH36, EH36 the values are allowed to be increased up to 20%

Conditions for recommended loads and design loads:

- The design resistance can be used for the design according the partial safety concept, e.g. EN 1993-1-1 (Eurocode 3).
- Global factor of safety  $\Omega$  resp. partial factor of safety  $\gamma_m$  (based on 5% fractile ultimate test value)

	Recommended loads	Design loads
static pull-out	2.80	2.00
static shear	2.80	2.00
- Minimum edge distance = 15 mm [0.59"], min. spacing  $\geq 18 \text{ mm [0.709"]}$
- Effect of base metal vibration and stress (e.g. areas with tensile stress) considered.
- Redundancy (multiple fastening) must be provided.
- Maximum displacement in direction of the shear force  $\leq 2.0 \text{ mm [0.08"]}$

**3.2.5 Recommended loads S-BT HL with Hilti coupler RC-MF and RC-MR**

S-BT-MR HL with coupler RC-MR 47/35 made of stainless steel				
Base material thickness	$t_{II} \geq 5 \text{ mm [0.20"]}$		$t_{II} = 4 \text{ mm [0.16"]}$	$t_{II} = 3 \text{ mm [0.12"]}$
Base material type	<b>Steel<sup>1)</sup></b> S235 A36	<b>Aluminum</b> $R_m \geq 270 \text{ N/mm}^2$	<b>Steel<sup>1)</sup></b> S235 A36	<b>Steel<sup>1)</sup></b> S235 A36
Tension, $N_{rec}$ [kN/lb]	3.60 / 810	2.10 / 470	2.30 / 520	2.30 / 520
Shear, $V_{rec}$ [kN/lb] For edge distance $c \geq 15 \text{ mm [0.59"]}$	0.34 / 75	0.29 / 65	0.34 / 75	0.29 / 65

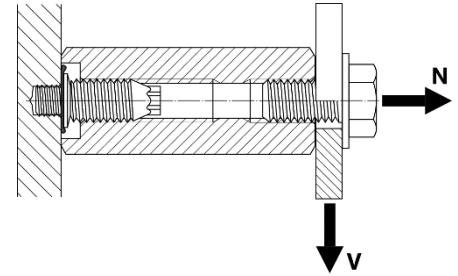

S-BT-MF HL / S-BT-MF MT HL with coupler RC-MF 47/35 made of duplex-coated carbon steel				
Base material thickness	$t_{II} \geq 5 \text{ mm [0.20"]}$		$t_{II} = 4 \text{ mm [0.16"]}$	$t_{II} = 3 \text{ mm [0.12"]}$
Base material type	<b>Steel<sup>1)</sup></b> S235 A36	<b>Aluminum</b> $R_m \geq 270 \text{ N/mm}^2$	<b>Steel<sup>1)</sup></b> S235 A36	<b>Steel<sup>1)</sup></b> S235 A36
Tension, $N_{rec}$ [kN/lb]	4.00 / 900	n.a.	2.30 / 520	2.30 / 520
Shear, $V_{rec}$ [kN/lb] For edge distance $c \geq 15 \text{ mm [0.59"]}$	0.34 / 75	n.a.	0.34 / 75	0.29 / 65

<sup>1)</sup> For steel base material of grade S355 to S500, AH36, DH36, EH36 the values are allowed to be increased up to 20%

**3.2.6 Design loads S-BT HL with Hilti coupler RC-MF and RC-MR**

S-BT-MR HL with coupler RC-MR 47/35 made of stainless steel				
Base material thickness	$t_{II} \geq 5 \text{ mm [0.20"]}$		$t_{II} = 4 \text{ mm [0.16"]}$	$t_{II} = 3 \text{ mm [0.12"]}$
Base material type	<b>Steel<sup>1)</sup></b> S235 A36	<b>Aluminum</b> $R_m \geq 270 \text{ N/mm}^2$	<b>Steel<sup>1)</sup></b> S235 A36	<b>Steel<sup>1)</sup></b> S235 A36
Tension, $N_{Rd}$ [kN/lb]	5.10 / 1145	3.00 / 670	3.30 / 740	3.30 / 740
Shear, $V_{Rd}$ [kN/lb] For edge distance $c \geq 15 \text{ mm [0.59"]}$	0.48 / 105	0.40 / 90	0.48 / 105	0.40 / 90

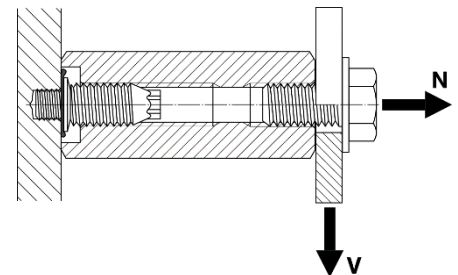

S-BT-MF HL / S-BT-MF MT HL with coupler RC-MF 47/35 made of duplex-coated carbon steel				
Base material thickness	$t_{II} \geq 5 \text{ mm [0.20"]}$		$t_{II} = 4 \text{ mm [0.16"]}$	$t_{II} = 3 \text{ mm [0.12"]}$
Base material type	<b>Steel<sup>1)</sup></b> S235 A36	<b>Aluminum</b> $R_m \geq 270 \text{ N/mm}^2$	<b>Steel<sup>1)</sup></b> S235 A36	<b>Steel<sup>1)</sup></b> S235 A36
Tension, $N_{Rd}$ [kN/lb]	5.70 / 1280	n.a.	3.30 / 740	3.30 / 740
Shear, $V_{Rd}$ [kN/lb] For edge distance $c \geq 15 \text{ mm [0.59"]}$	0.48 / 105	n.a.	0.48 / 105	0.40 / 90

<sup>1)</sup> For steel base material of grade S355 to S500, AH36, DH36, EH36 the values are allowed to be increased up to 20%

**Conditions for recommended loads and design loads:**

- The design resistance can be used for the design according the partial safety concept, e.g. EN 1993-1-1 (Eurocode 3).
- Global factor of safety  $\Omega$  resp. partial factor of safety  $\gamma_m$  (based on 5% fractile ultimate test value)
 

	Recommended loads	Design loads
static pull-out	2.80	2.00
static shear	2.80	2.00
- Minimum edge distance = 15 mm [0.59"], min. spacing  $\geq$  18 mm [0.709"]
- Effect of base metal vibration and stress (e.g. areas with tensile stress) considered.
- Redundancy (multiple fastening) must be provided.
- Maximum displacement in direction of the shear force  $\leq$  2.0 mm [0.08"]

**3.2.7 Recommended interaction formula for combined loading – steel and aluminum base materials**

**V-N** (shear and tension)  $\frac{V}{V_{rec}} + \frac{N}{N_{rec}} \leq 1.0$  with  $\frac{V}{V_{rec}} \leq 1.0$  and  $\frac{N}{N_{rec}} \leq 1.0$

**V-M** (shear and bending)  $\frac{V}{V_{rec}} + \frac{M}{M_{rec}} \leq 1.0$  with  $\frac{V}{V_{rec}} \leq 1.0$  and  $\frac{M}{M_{rec}} \leq 1.0$

**N-M** (tension and bending)  $\frac{N}{N_{rec}} + \frac{M}{M_{rec}} \leq 1.0$

**V-N-M** (shear, tension and bending)  $\frac{V}{V_{rec}} + \frac{N}{N_{rec}} + \frac{M}{M_{rec}} \leq 1.0$

**3.2.8 Base material thickness  $t_{II}$  and type of bore hole**

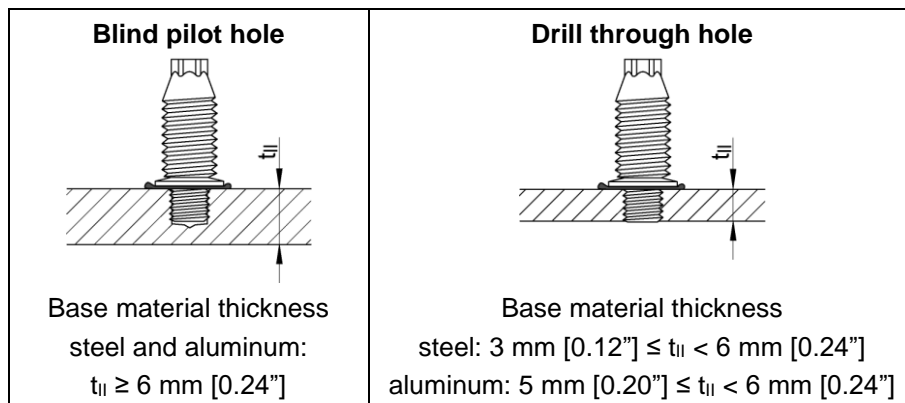

Thickness of base material corrosion protection layer  $\leq$  1.0 mm [0.039"].

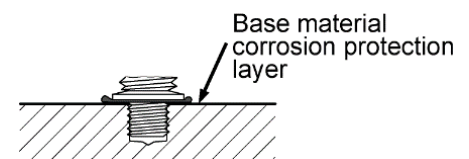



**Corrosion information:**

The S-BT HL stainless steel fasteners are made from the duplex stainless steel type 1.4462, which is equivalent to AISI 316L (A4) and 318LN steel grade. This grade of stainless steel is classified in the corrosion resistance class IV according to DIN EN 1993-1-4:2015, which makes the material suitable for aggressive environments like in coastal and offshore applications. The microstructures of duplex stainless steels consist of a mixture of austenite and ferrite phases. Compared to the austenitic stainless steel grades, duplex stainless steels are magnetic. The surface of the S-BT stainless steel fasteners is zinc-coated (anti-friction coating) in order to reduce the thread forming torque when the stud is screwed in into the base material.

The coating of the carbon steel S-BT fasteners consists of an electroplated Zn-alloy for cathodic protection and a top coat for chemical resistance (Duplex-coating). The use of this coating is limited to the corrosion category C1, C2 and C3 according the standard EN ISO 9223. For higher corrosion categories stainless steel fasteners should be used.

**Note:**

ETA-23/0001 allows the use of carbon steel threaded studs with duplex coating only in dry indoor environment (C1 acc. to EN ISO 9223).

In case of a **drill through hole or a pilot hole in thin base material**, rework of the coating on the back side of the plate / profile may be needed.

	S-BT-MF HL S-BT-MF MT HL S-BT-GF HL		S-BT-MR HL S-BT-GR HL	
Corrosivity category C	C3 medium corrosive		C5 very high corrosive	
Drill hole type and base material thickness $t_{II}$ <sup>1)</sup>	Topside protection	Backside Protection	Topside protection	Backside Protection
Drill through hole $3 \text{ mm } [0.12"] \leq t_{II} < 6 \text{ mm } [0.24"]$	✓	✗ <sup>2)</sup>	✓	✗ <sup>2)</sup>
Blind pilot hole $t_{II} \geq 6 \text{ mm } [0.24"]$	✓	✓	✓	✓

<sup>1)</sup> Real base material thickness, not nominal material thickness or material thickness with coating.

<sup>2)</sup> Damage of the coating on the back side of the plate / profile require a rework of the coating.

**3.2.9 Thickness of fastened material  $t_I$** 

S-BT-\_\_\_\_\_/7 \_\_\_\_\_  $1.6 \text{ mm } [0.063"] \leq t_I \leq 7.0 \text{ mm } [0.28"]$

S-BT-\_\_\_\_\_/15 \_\_\_\_\_  $1.6 \text{ mm } [0.063"] \leq t_I \leq 15.0 \text{ mm } [0.59"]$

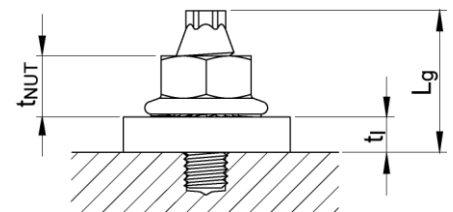

### 3.2.10 Spacing and edge distances

Edge distance:  
 $\geq 6 \text{ mm}$  [0.236"]

Spacing:  
 $\geq 18 \text{ mm}$  [0.709"] for all S-BT M8 HL  
 $\geq 22 \text{ mm}$  [0.866"] for all S-BT M10 HL and  
 S-BT W10 HL

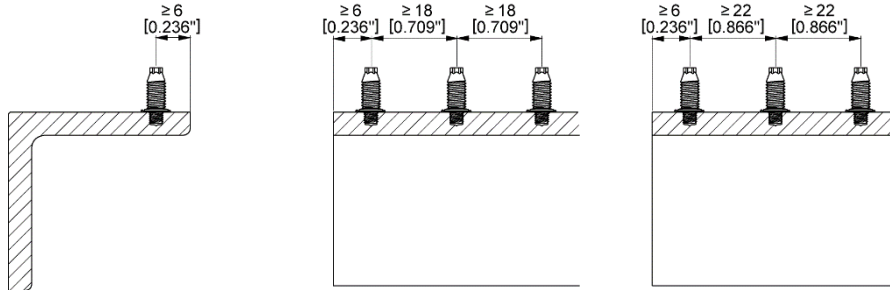

### 3.2.11 Installation temperature and service temperature

The installation temperature is the temperature at which the S-BT HL studs are installed. A distinction is made between the temperature of the base material and the temperature of the S-BT HL studs, drilling and installation tools and accessories. Concerning the temperature range of the drilling and setting tools see the respective operating instructions. Provided the tools are operated within their allowed range, fasteners can be installed into materials down to  $-40 \text{ }^{\circ}\text{C}$  base steel temperature. Condition here is, that the toughness specification of such base steels allows material use in that low temperature range. The installation temperature range can be found in the table below.

The service temperature is the temperature at which the S-BT HL studs operate. The S-BT HL studs will operate effectively and without any loss in performance (loads, sealing function, etc.) within the specified service temperature range. The recommended service temperature in marine atmospheres amounts between  $-40 \text{ }^{\circ}\text{C}$  to  $+60 \text{ }^{\circ}\text{C}$ . The use up to  $+100 \text{ }^{\circ}\text{C}$  ambient temperature is possible when the specific environmental conditions for these cases are taken into account. Those limits are determined by the sealing function of the rubber material of the sealing washer of the S-BT threaded studs. Outside this temperature range the S-BT HL studs may fail.

	Installation temperature		Service temperature	
	min	max	min	max
Base material	$-40 \text{ }^{\circ}\text{C}$	$+60 \text{ }^{\circ}\text{C}$	$-40 \text{ }^{\circ}\text{C}$	$+60 \text{ }^{\circ}\text{C}$
S-BT HL studs	$-10 \text{ }^{\circ}\text{C}$	$+60 \text{ }^{\circ}\text{C}$	$-40 \text{ }^{\circ}\text{C}$	$+60 \text{ }^{\circ}\text{C}$
Drilling & installation tools and accessories	$-10 \text{ }^{\circ}\text{C}$	$+60 \text{ }^{\circ}\text{C}$	n.a.	n.a.

**Note:**

The service temperature range of the connected cable lugs and cables has to be observed. For details please contact the supplier of the cable lugs and cables.  
 When using Hilti S-BT HL fasteners in combination with fire rated boundaries in Shipbuilding facilities, the maximum service temperature for a period of 60 minutes is higher. For more details refer to section 5.10 "Fire resistance".

### 3.2.12 Application limit and thickness of base material

The base material is limited to steel grade with a maximum tensile strength  $f_u = 760 \text{ MPa}$  [110 ksi].

The minimum tensile strength of steel is  $f_u \geq 360 \text{ MPa}$  [52 ksi].

The minimum tensile strength of aluminum is  $f_u \geq 270 \text{ MPa}$  [39 ksi].

Minimum thickness of base material  $t_{II}$ : refer to section 3.2.8

Maximum thickness of base material  $t_{II}$ : no limits

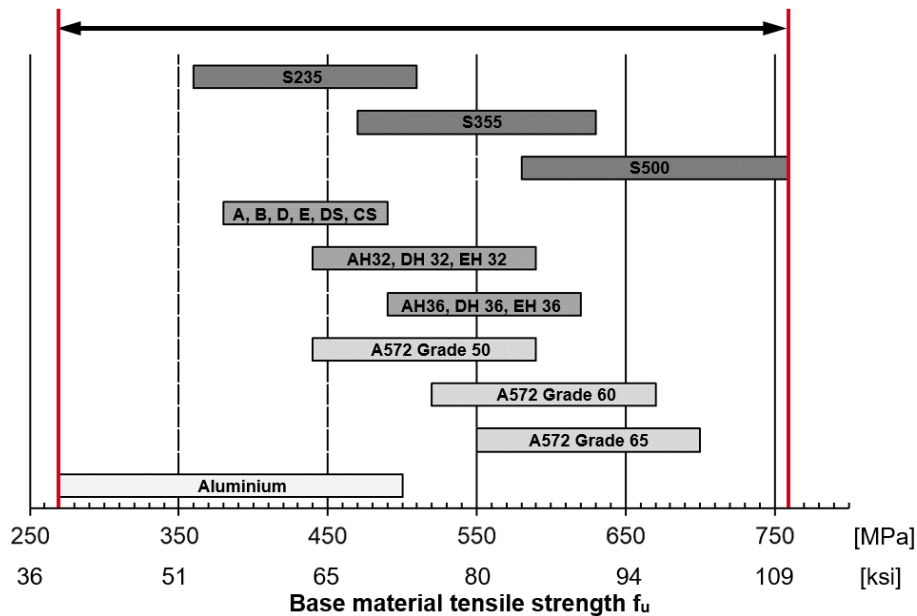

### 3.2.13 Fastening quality assurance and fastening inspection

The installer is responsible for the correct setting of the S-BT HL studs. Using the S-IC BT Inspection Card for checking the correct setting of the stud is not required for every stud. In most cases, a visual check of the correct setting in accordance with the 'S-BT visual inspection catalogue' is sufficient. The S-IC BT Inspection Card can be used to check the standoff in cases where the washer compression of the S-BT HL is assessed as incorrect (over or under compressed).

Verify stud standoff  $h_{NVS}$  with S-IC BT inspection card.

**S-BT-\_\_\_/7\_\_\_6**  $h_{NVS} = 18.6 \text{ mm to } 19.1 \text{ mm}$  [0.732" to 0.752"]

**S-BT-\_\_\_/15\_\_\_6**  $h_{NVS} = 29.3 \text{ mm to } 29.8 \text{ mm}$  [1.153" to 1.173"]

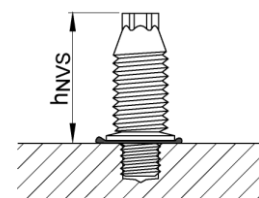

Definition of stud standoff  $h_{NVS}$ .

**3.2.14 Fastener selection and system recommendation**

Fastener		Drilling tool	Drill bit	Setting tool
Stainless Steel	S-BT-GR M8/7 SN 6 HL	SBT 6-22 w/ drill assist	TS-BT 5.3-95 S	SBT 6-22 + S-SH BT M8
	S-BT-GR M8/7 SN 6 HL AL		TS-BT 5.5-74 AL	
	S-BT-MR M8/7 SN 6 HL		TS-BT 5.3-65 S	SBT 6-22 + S-SH BT M10/W10
	S-BT-MR M8/15 SN 6 HL			
	S-BT-MR M10/15 SN 6 HL			
	S-BT-MR W10/15 SN 6 HL			
	S-BT-ER M8/15 SN 6 HL			
	S-BT-ER M10/15 SN 6 HL		SBT 6-22 + S-SH BT M10/W10	
	S-BT-ER W10/15 SN 6 HL			
	S-BT-MR M8/7 SN 6 HL AL		TS-BT 5.5-74 AL	SBT 6-22 + S-SH BT M8
	S-BT-MR M8/15 SN 6 HL AL			
	S-BT-MR M10/15 SN 6 HL AL			SBT 6-22 + S-SH BT M10/W10
	S-BT-MR W10/15 SN 6 HL AL			
	S-BT-ER M10 HC 120 HL		TS-BT 5.3-65 S	SBT 6-22 + S-SH BT M10/W10
	S-BT-ER W10 HC 4/0 HL		TS-BT 5.3 HC	
Carbon Steel	S-BT-GF M8/7 AN 6 HL	SBT 6-22 w/ drill assist	TS-BT 5.3-95 S	SBT 6-22 + S-SH BT M8
	S-BT-MF M8/7 AN 6 HL		TS-BT 5.3-65 S	
	S-BT-MF M8/15 AN 6 HL			
	S-BT-MF M10/15 AN 6 HL			SBT 6-22 + S-SH BT M10/W10
	S-BT-MF W10/15 AN 6 HL			
	S-BT-MF MT M10/15 AN 6 HL			SBT 6-22 + S-SH BT M8
	S-BT-MF MT W10/15 AN 6 HL			
	S-BT-EF M8/15 AN 6 HL		TS-BT 5.3-65 S	SBT 6-22 + S-SH BT M10/W10
	S-BT-EF M10/15 AN 6 HL			
	S-BT-EF W10/15 AN 6 HL			
	S-BT-EF M10 HC 120 HL			
	S-BT-EF W10 HC 4/0 HL			

Fastener	Standoff adapter		Standoff length
S-BT-GR M8/7 SN 6 HL	Stainless steel	Adapter M8-MR 25	25 mm [1"]
		Adapter M8-MR 50	50 mm [2"]
		Adapter M8-MR 75	75 mm [3"]
		Adapter M8-MR 100	100 mm [4"]
S-BT-GF M8/7 AN 6 HL	Carbon steel	Adapter M8-MF 25	25 mm [1"]
		Adapter M8-MF 50	50 mm [2"]
		Adapter M8-MF 75	75 mm [3"]
S-BT-MR M10/15 SN 6 HL	Stainless steel	Adapter M10-MR 50, -MR 75, -MR 100	50 mm [2"], 75 mm [3"], 100 mm [4"]
		Adapter M10-MF 50	50 mm [2"]
		Adapter W10-MR 50, -MR 75, -MR 100	50 mm [2"], 75 mm [3"], 100 mm [4"]
S-BT-MF MT W10/15 AN 6 HL	Carbon steel	Adapter W10-MF 50	50 mm [2"]

**3.2.15 Installation details**

**S-BT made of stainless steel with washer-Ø 12mm (S-BT-\_R HL) and S-BT made of carbon steel with washer-Ø 12mm (S-BT-MF MT HL)**

Fastened material hole Ø: 13 mm [0.51"] ≤ Ø ≤ 18 mm [0.71"]

for stud M10 / W10

Fastened material hole Ø: 13 mm [0.51"] ≤ Ø ≤ 14 mm [0.55"] for stud M8

**S-BT made of carbon steel with washer-Ø 10mm (S-BT-\_F HL)**

Fastened material hole Ø: 11 mm [0.43"] ≤ Ø ≤ 18 mm [0.71"]

for stud M10 / W10

Fastened material hole Ø: 11 mm [0.43"] ≤ Ø ≤ 14 mm [0.55"] for stud M8

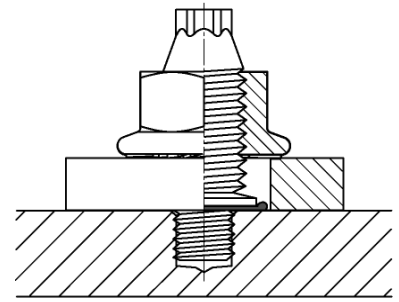

Important: for group fastenings subjected to shear loading the fastened material hole diameter should not exceed 14 mm [0.55"] (S-BT-\_R HL and S-BT-MF MT HL) and 12 mm [0.47"] (S-BT-\_F HL) respectively.

**Installation with Hilti SBT 6-22 cordless drill driver**
**① Mark location for each fastening**
**② Pre-drill with TS-BT stepped drill bit**

Usage of drill driver SBT 6-22.

Using "Drilling assist" mode. Set the gear selector switch to 2 and BT clutch setting. Speed of the tool reduces automatically when the hole is drilled to the correct depth. A shiny ring should be visible around the borehole after the drilling process.

Before fastener installation: The drilled hole and the area around the drilled hole must be clear of liquids and debris.



Hilti SBT 6-22 using "drill assist" mode.

**③ Screw-in S-BT studs into drilled hole**

Usage of drill driver Hilti SBT 6-22 in combination with the stud holder S-SH BT.

Using "Fasten S-BT stud" mode. Set the gear selector switch to 1 and BT clutch setting. Insert the S-BT HL stud into the stud holder. The torque limiter trips when the stud reaches the correct depth.

The S-IC BT inspection card can be used to check the standoff in cases where the washer compression of the S-BT HL is assessed as incorrect (over or under compressed).

Sealing washer must be properly compressed!



Hilti SBT 6-22 using "fasten S-BT stud" mode.

**○ Fasten component or grating on base material**

Position component or grating on S-BT HL studs and hold in place.

Tighten the nuts or grating fastener with the suited tightening torque T. T refer to table below.

Tighten the nuts using

- SBT 6-22 and suitable wrench socket S-NS, or
- torque tool S-BT ¼" (16 Nm) , X-BT ¼" (8 Nm) or S-BT ¼" (5 Nm), or
- torque wrench and wrench socket



Shiny ring around the bore hole

	T *)	
	8 Nm	16 Nm
Hilti drill driver:	Torque setting:	
<b>SBT 6-22</b>	<b>3</b>	<b>4</b>

\*) T for grating application: refer to Product Data Sheet for X-FCM grating faster.

**Tightening torque serrated flange nut (Multipurpose Fastenings):**

Base material thickness	S-BT HL				
	$t_{II} \geq 5 \text{ mm [0.20" ]}$			$3 \text{ mm} \leq t_{II} < 5 \text{ mm}$	
Base material	<b>Steel</b> S235 A36	<b>Steel</b> S355 to S500 Grade 50	<b>Aluminum</b> $R_m \geq 270$ N/mm <sup>2</sup>	<b>Steel</b> S235 A36	<b>Steel</b> S355, S420 Grade 50
Tightening torque serrated flange nut <b>T [Nm/lbft]</b>	16 / 11.8	16 / 11.8	8 / 5.9	8 / 5.9	8 / 5.9

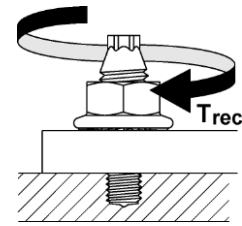

**Important notes:**

The tightening torque (T) for the serrated flange nut is dependent on the base material type and thickness. Exceeding the tightening torque (T) leads to damage of the S-BT HL stud's anchorage with negative impact on the load values and the sealing function.

**Tightening torque S-BT-ER HL and S-BT-EF HL (Electrical Connections):**

**Single point connection type A and double point connection type A**

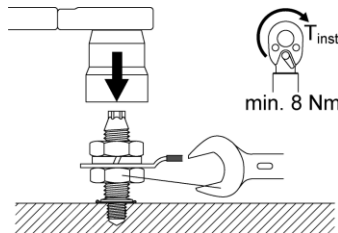

Hold the bottom nut with a spanner while tightening the upper nut.

Tightening Torque: Min. 8 Nm  
Max. 20 Nm

**Single point connection type B**

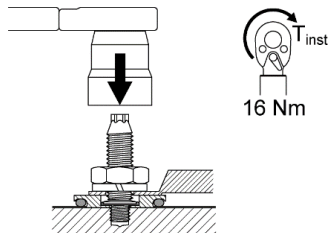

The tightening torque is **8 - 16 Nm**. Exceeding or falling below this tightening torque value is not allowed.

Tighten the nut using torque tool S-BT 1/4", torque wrench or Hilti screw driver SBT 6-22 and suitable wrench socket S-NS.

**Single point connection with Hilti standoff adapter**

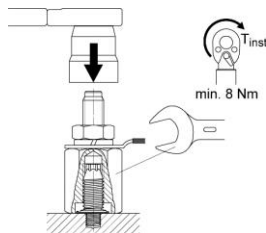

Hold the standoff adapter with a spanner while tightening the **upper nut**.

Tightening Torque: Min. 16 Nm  
Max. 20 Nm

The tightening torque of the **standoff adapter** is **8 Nm**. Exceeding or falling below this tightening torque value is not allowed. Tighten the nut using torque tool S-BT 1/4" (16 Nm), torque wrench or Hilti screw driver SBT 6-22 and suitable wrench socket S-NS.

**Tightening torque X-FCM and X-FCS-R Grating Fastening Systems:**

Refer to chapter 2.1 and 2.2 and review / follow the instructions for use (IFU) accompanying the product.

**Important notes:**

The setting of the torque via the Hilti screwdriver with torque release coupling (TRC) can change as the clutch wears over time. The specified torque setting is only a rough guide value and applies to a new Hilti screwdriver. To ensure recommended torque is applied, Hilti recommends the use of a calibrated torque wrench or the Hilti torque tool

The specified torque setting for the Hilti screw drivers with electronic slip clutch (ESC) is only a rough guide value as the ESC has 2 stop detections; Soft Joint (SJ) detection and Hard Joint (HJ) detection. The hard joint detection is activated due to drop in speed (fast stop) and can lead to a torque spike. The installation torque may vary depending on the user and the application. To ensure recommended torque is applied, Hilti recommends the use of a calibrated torque wrench or the Hilti torque tool.

These are abbreviated instructions which may vary by application.  
ALWAYS review / follow the instructions for use (IFU) accompanying the product.  
In case of a **drill through hole**, rework of the coating on the back side of the plate / profile may be needed.

## 4 PERFORMANCE

### 4.1 Nomenclature and symbols

The symbols and nomenclature used in the technical data are listed below.

#### Fastener test data and performance

<b>N</b> and <b>V</b>	Tensile and shear forces in a general sense
<b>F</b>	Combined force (resulting from <b>N</b> and <b>V</b> ) in a general sense
<b>N<sub>S</sub></b> and <b>V<sub>S</sub></b>	Tensile and shear forces in a design calculation
<b>F<sub>S</sub></b>	Combined force (resulting from <b>N<sub>S</sub></b> and <b>V<sub>S</sub></b> ) in a design calculation
<b>N<sub>u</sub></b> and <b>V<sub>u</sub></b>	Ultimate tensile and shear forces that cause failure of the fastening, statistically, the reading for one specimen
<b>N<sub>u,m</sub></b> and <b>V<sub>u,m</sub></b>	Mean ultimate tensile and shear forces that cause failure of the fastening, statistically, the average for a sample of several specimens
<b>S</b>	The standard deviation of the sample
<b>N<sub>R,k</sub></b> and <b>V<sub>R,k</sub></b>	Characteristic tensile and shear resistance of the fastening, statistically, the 5% fractile. For example, the characteristic strength of a fastening whose ultimate strength can be described by a standard Gauss type distribution is calculated by $N_{R,k} = N_{u,m} - k \times S$ where <b>k</b> is a function of the sample size, n and desired confidence interval.
<b>N<sub>rec</sub></b> and <b>V<sub>rec</sub></b>	Recommended maximum tensile and shear loads of the threaded fastener tip: $N_{rec} = \frac{N_{R,k}}{\Omega}$ and $V_{rec} = \frac{V_{R,k}}{\Omega}$ where <b>Ω</b> is the overall factor of safety
<b>M<sub>rec</sub></b>	Recommended elastic moment for the fastener shank $M_{rec} = \frac{M_{R,k}}{\Omega}$ where <b>M<sub>R,k</sub></b> is the characteristic elastic moment resistance of the threaded fastener tip and <b>Ω</b> is an overall factor of safety. Unless otherwise stated on the product data sheets, the <b>M<sub>rec</sub></b> values in this manual include a safety factor of "1.75" for static loading.
<b>N<sub>R,d</sub></b> and <b>V<sub>R,d</sub></b>	Design tensile and shear resistance of the fastening $N_{R,d} = \frac{N_{R,k}}{\gamma_m}$ and $V_{R,d} = \frac{V_{R,k}}{\gamma_m}$ where <b>γ<sub>m</sub></b> is the partial factor of safety
<b>T</b>	Tightening torque [Nm or lbft]

#### Fastening details

<b>h<sub>ef</sub></b>	Screw-in depth of the threaded fastener tip below the surface of the base material
<b>h<sub>NVS</sub></b>	S-BT stud head standoff above the surface of the base material
<b>t<sub>I</sub></b>	Thickness of the fastened material
<b>t<sub>II</sub></b>	Thickness of the base material
<b>Σ t<sub>I</sub></b>	Total thickness of the fastened material (where more than one layer is fastened)
<b>t<sub>Nut</sub></b>	Thickness of the serrated flange nut

#### Characteristics of steel and other metals

<b>f<sub>y</sub></b>	Yield strength of metals [N/mm <sup>2</sup> or MPa]
<b>f<sub>u</sub></b>	Ultimate tensile strength of metals [N/mm <sup>2</sup> or MPa]



### 4.2 Design concepts

The recommended working loads  $N_{rec}$  and  $V_{rec}$  are generally suitable for use in typical working load designs.

Working load concept	Partial safety concept
$N_S \leq N_{rec} = \frac{N_{R,k}}{\Omega}$ <p>where <math>\Omega</math> is an overall factor of safety including allowance for:</p> <ul style="list-style-type: none"> <li>errors in estimation of load</li> <li>deviations in material and workmanship</li> </ul> <p>and <math>N_s</math> is, in general, a characteristic acting load.</p> <p><math>N_S \approx N_{S,k}</math></p>	$N_{S,d} \leq N_{R,d}$ $N_{S,d} = N_{S,k} \times \gamma_F$ $N_{R,d} = \frac{N_{R,k}}{\gamma_M}$ <p>where <math>\gamma_F</math> is a partial factor of safety to allow for errors in estimation on the acting load.</p> <p><math>\gamma_M</math> is a partial factor of safety to allow for deviations in material and workmanship.</p>

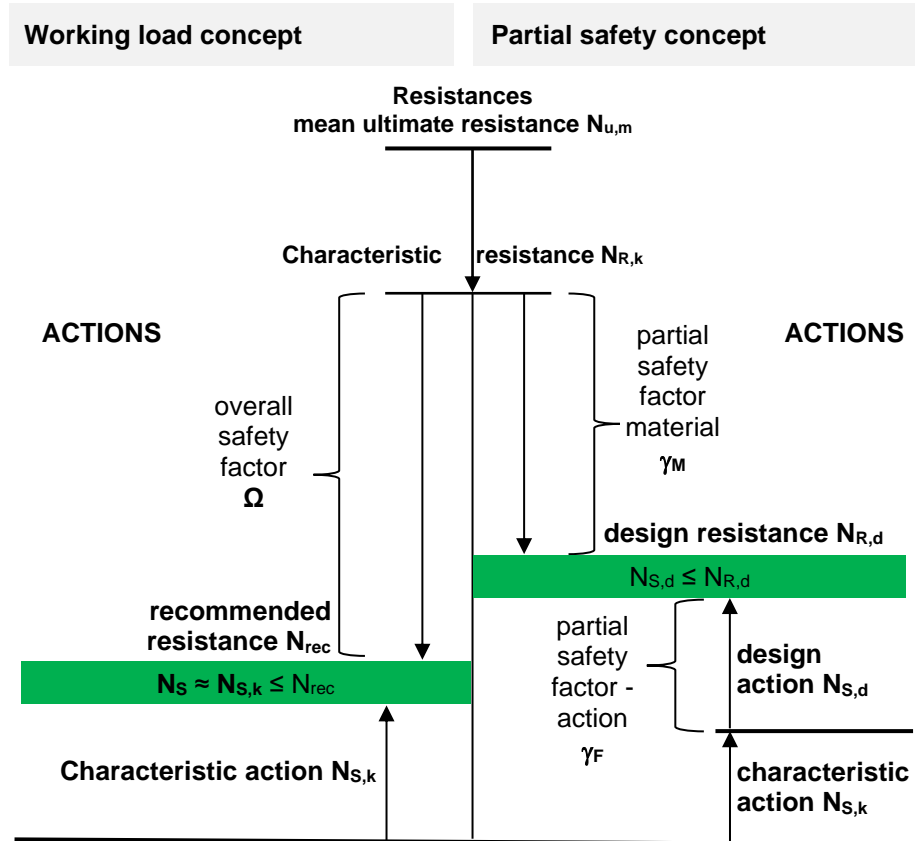

### 4.3 Static capacity of the S-BT HL threaded stud

#### 4.3.1 Tensile load deformation behaviour of S-BT HL threaded stud fastenings

**Tension, shear and bending tests with S-BT HL screw-in threaded studs,**  
 Report No. 084/22 HTL Rankweil, Bautechnische Versuchsanstalt, October 2022

Base material (steel with coating thickness 0,8 mm)	Steel, 5 mm thick, S235 ( $f_u \approx 360$ MPa)
	S355 ( $f_u \approx 470$ MPa)
	Steel, 3 mm thick, S235 ( $f_u \approx 360$ MPa)
	S235 ( $f_u \approx 360$ MPa)
	Aluminium, 5 mm thick, EN AW 5754 ( $f_u \approx 270$ MPa)

Number of fastenings in test	70
	40 in steel S235
	20 in steel S355
	10 in Aluminium

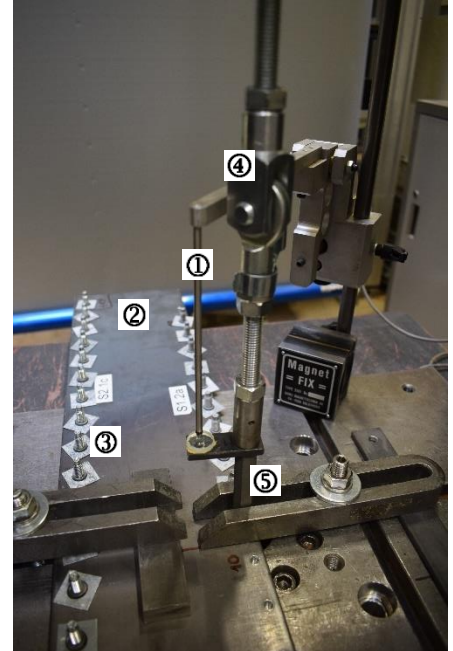
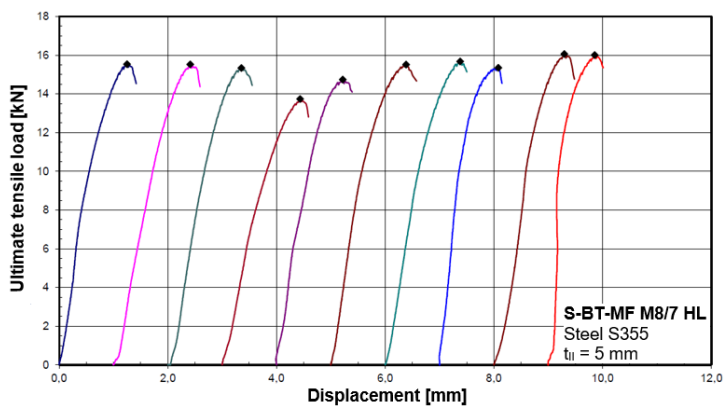
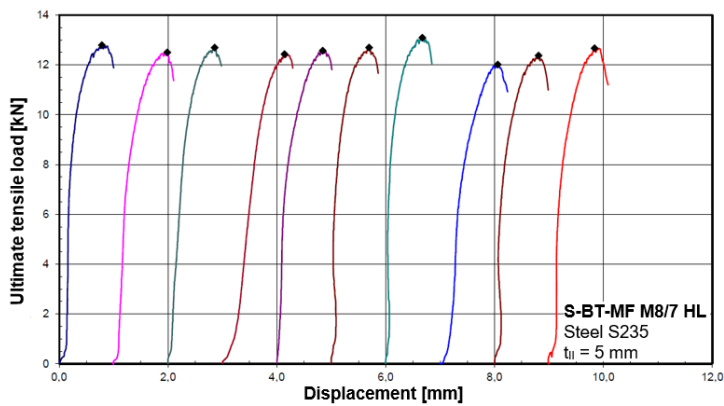

- ① Displacement transducer
- ② Base material
- ③ S-BT HL stud
- ④ Hinge (connection to load cell)
- ⑤ Threaded sleeve

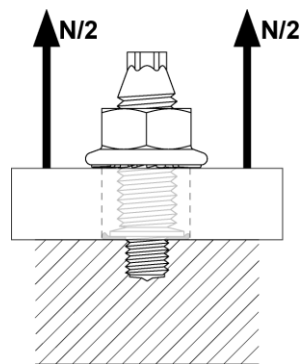

### Conclusions

- Pull-out strength increases with increasing base material strength and screw-in depth
- The fasteners show a well-tempered elastic behavior with a displacement from 0.7 – 2.0 mm until the ultimate pull-out load value is reached.

- Elastic stiffness is independent from the base material strength. It depends on the base material thickness and base material type (steel vs. aluminum).
- After the maximum loading capacity of the fastener is reached, no remaining load value is left due to the pull-out of the S-BT HL stud from the base material.

### 4.3.2 Pull-out strength of S-BT HL threaded stud fastenings

**Tension, shear and bending tests with S-BT HL threaded studs,**  
 Report No. 084/22 HTL Rankweil, Bautechnische Versuchsanstalt, October 2022

Base material	ref. to 4.3.1
Number of fastenings in test	ref. to 4.3.1

#### Ultimate pull-out load

The effect of the base material type, strength and base material thickness (screw-in depth) can be observed.

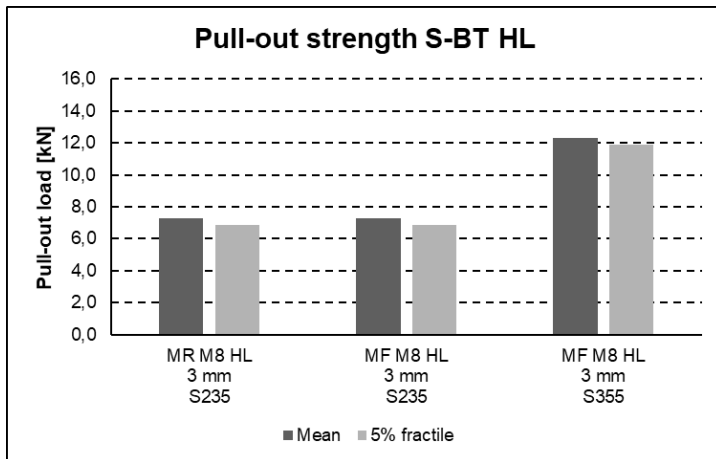
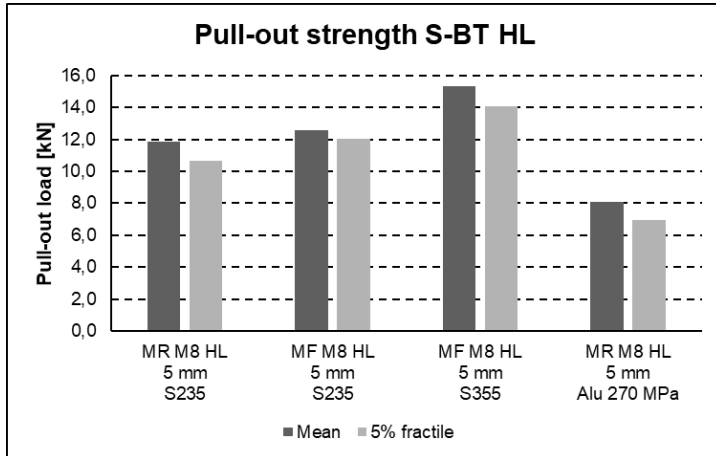
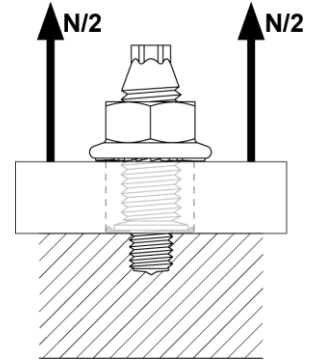

Test set up for tension tests

### Conclusions

- The failure mode for all tensile tests was pull-out of the fastener from the bore hole.
- The effect of the base material strength is given for all tested base metal thicknesses.
- The most important parameter affecting the pull-out strength is the base material strength and base material type (steel vs. aluminum).
- The thread size of the upper part of the fastener doesn't affect the pull-out load value because the geometry of the tapping thread is identical for all studs made of the same material.

### 4.3.3 Shear strength of S-BT HL threaded stud fastenings

**Tension, shear and bending tests with S-BT HL threaded studs,**  
 Report No. 084/22 HTL Rankweil, Bautechnische Versuchsanstalt, October 2022

Base material	ref. to 4.3.1
Number of fastenings in test	ref. to 4.3.1

#### Ultimate shear load

The shear failure occurs through breakage of the stud in the cross section of the tap thread or through plastic deformation of the hole in the base material which leads to tilting and pull-out of fastener.

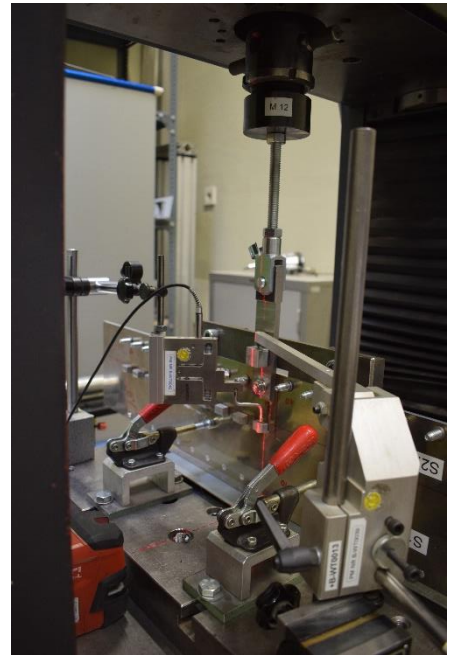
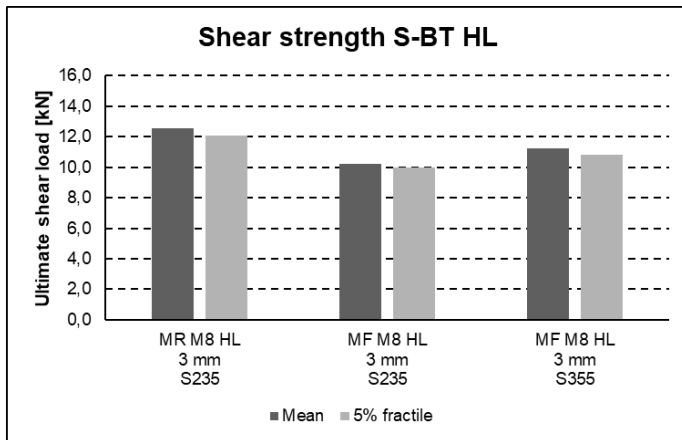
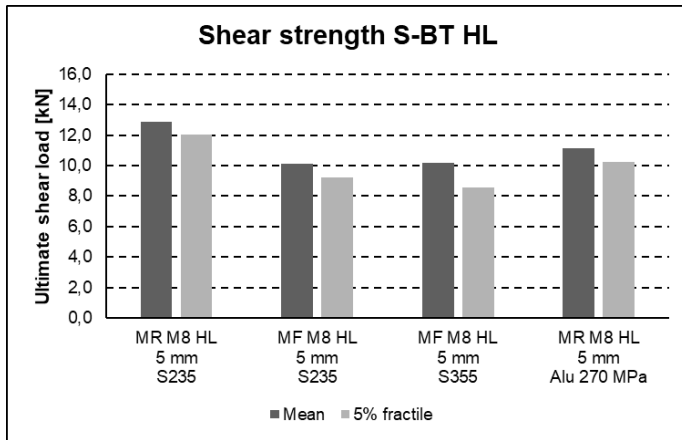
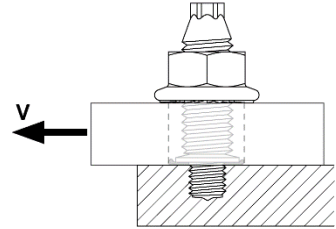

Test set up for shear load testing

#### Conclusions

- In the steel base material 77% of the S-BT HL studs failed due to shear fracture in the cross section of the tap thread. 23% failed due to plastic deformation of the bore hole, tilting of the studs and subsequent pull-out. In the aluminum base material deformation of the bore hole, tilting of the studs and subsequent pull-out of the studs was the decisive failure mode.
- The effect of the steel base material strength is only visible for 3 mm steel base material.
- The most important parameters affecting the shear load capacity is the type of the base material (steel vs. aluminum) and the material of the S-BT HL stud.

- The thread size of the upper part of the fastener doesn't affect the shear load capacity because the geometry of the tapping thread is identical for all studs made of the same material.

#### 4.4 S-BT HL in stainless steel base material

Tests at Hilti AG; Schaan 2022

##### General comments

Stainless steels mainly differ from non-alloy structural steels in the following properties:

- higher resistance to corrosion and acids
- higher toughness and thus poor machinability (e.g. when drilling, turning)
- lower thermal conductivity and lower electrical conductivity

The machinability of stainless steels causes some problems due to their lower thermal conductivity compared to other steels. When drilling in stainless steel, it must be taken into account that the drilling process may take longer, the drill bit may wear faster and it may be more difficult to form the thread in the stainless steel.

##### Test concept

Drilling / installation tool	SBT 4-A22
Type of drill bit:	TS-BT 5.3-65 S (standard drill bit)
Base material steel type:	Stainless steel 1.4404 (EN 10088), 316L (AISI), S31603 (UNS) 1.4362 (EN 10088), S32304 (UNS) S32003 (UNS)
Base material thickness:	10 mm (1.4404), 12 mm (1.4362)
# of bore holes:	500 drilling operations with 2 drill bits
Drilling direction:	Handheld operation, vertical and horizontal

##### Test results

- Even after more than 200 drill holes, the drill diameter was still within the specified tolerance range.
- The S-BT HL studs could be screwed into the base material with the installation tools recommended in the instruction for use (IFU) and section 0.
- The ultimate pull-out load values are on the same level compared to the load values in non-alloy structural steel.
- The thread forming torque during the screw-in process was below the specified maximum value.

##### Conclusions

- The standard drill bit TS-BT 5.3-65 S can be used for drilling the bore holes
- The screwdrivers listed in the instruction for use (IFU) and section 0 can be used for drilling the bore holes and for installing the S-BT HL studs.
- The load data from section 3.2 can be used for the design.
- The maximum tensile strength of the base material made of stainless steel is limited to  $f_u = 760 \text{ MPa}$  [110 ksi].

##### Note:

For stainless steel base material only S-BT HL threaded studs made of stainless steel material should be used.

Each S-BT HL sales box includes the corresponding TS-BT stepped drill bit. Hilti recommends disposing of the used TS-BT stepped drill bit once the complete sales packaging S-BT HL studs are consumed. Hilti then advises using the new stepped drill bit out of the new sales packaging.



Stainless steel test plates with drilled pilot holes



Testing of pilot hole quality

#### 4.5 Vibration effects on S-BT HL threaded stud fastenings

Hilti AG; Schaan 2022

##### Introduction

For the selection of a fastener and design of a fastening point, it is important to understand the actions that it will be subjected to. Actions are here defined as loads and displacements. The following section explains the different types of actions that exist and how they relate to different vibration types.

Depending on their profile vs time, actions can be classified as:



- Static actions
- Dynamic actions

Static actions affecting a fixture (part to be fastened) include the following:

- Dead loads (e.g. self-weight)
- Permanent actions (e.g. sinking of supports)
- Variable actions (e.g. temperature fluctuations)

Categories of dynamic actions and their relation to vibration:

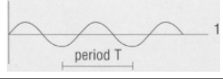
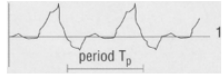
Dynamic actions vary in magnitude and/or position over time and thereby cause non-negligible inertial and damping forces. Static actions, in comparison, do not change in magnitude or position over time. Such static actions do not result in vibration and are not further considered in this section. Broadly speaking, dynamic actions correspond with forced vibrations, with harmonic, periodic and transient actions creating time-varying disturbances. An impulse action could result in free vibration if it is a one-off occurrence. However, in the event that it is recurring (with no fixed frequency), it would then also result in a time-varying disturbance (forced vibration).

Action	Pattern	Possible cause
Harmonic	 Sinusoidal, periodic	Rotating machines, Turbomachinery
Periodic	 Arbitrary, periodic	Regularly impacting parts, e.g. Shaker, Conveyor belts
Transient	 Arbitrary, non periodic	Earthquakes, vehicle traffic, foot traffic, pipe flow
Impact	 Arbitrary, very short time of action	Impact, explosion

**Table 1:** Types of Dynamic Actions

##### Differentiation between fatigue-relevant actions and vibrations

Actions resulting in fatigue are characterized by a large number of load cycles with significant magnitude, resulting in changes in stress within the affected fastening point. After a certain number of load cycles, these stresses cause a reduction in the strength of the fastening.

If a fastener is subjected to dynamic actions, failure by breakage can occur after a certain number of load cycles. Failure by breakage can occur, even if the maximum stress is significantly below the yield strength of the material. This is referred to as fatigue failure.

S-BT HL threaded studs are intended to be used for fixings exposed to predominantly static actions. S-BT HL threaded studs are not intended to be used for fastenings which are directly subjected to fatigue-relevant actions, (i.e. actions applied directly to the fixing that result in repeated shear or tensile loading/unloading of the fastener). Therefore, fatigue failure is not considered



in the following tests. S-BT HL studs are often subject to the response of a mechanical system to dynamic actions. In the presence of nearby machinery, people and other moving objects, fasteners can be subject to vibration. Under vibration, fixings can experience self-loosening.

Self-loosening of threaded assemblies can have multiple causes, such as vibration, insufficient clamping force/load, or poorly fitting parts. When relative movement between elements of a fastening point is allowed, the risk of self-loosening increases. The most frequent cause of loosening is shear slip of the threaded assembly (nut or grating disc) relative to the joint. This results in relative motion occurring between the threads, leading to a rotational loosening of the fastener. Vibration which may result in rotational loosening, but never in fatigue failure, is investigated in this section of the document.

**Different Vibration Sources**

The following descriptions refer to Figure 1, which provides a visualization of the different vibration sources considered.

(1) Base material vibration (Source 1)

The S-BT threaded studs are subjected to base material vibration, where the structural beams are vibrating due to the harmonic or periodic load being induced by the nearby machine (source).

(2) Foot traffic vibration of grating (Source 2)

The grating is subject to the transient load of the footsteps of the person walking across it. The source of the loading is the person walking. The grating responds to each footstep through dampened oscillations (vibration). In addition, the grating and the fasteners fixing it can also be subject to the base material vibration induced by Source 1, transmitted through the steel substructure.

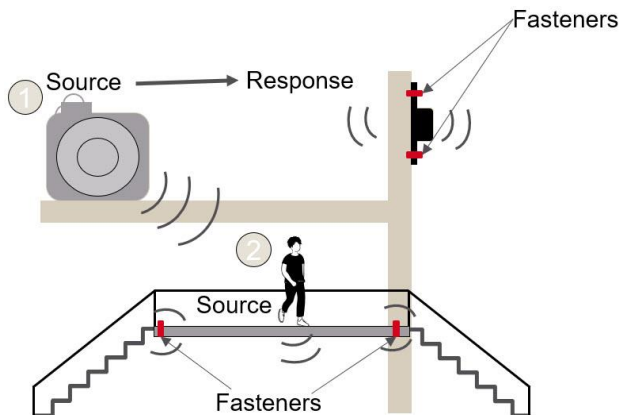

**Figure 1:** Examples of Typical Vibration Sources

**Experimental program**

Hilti has completed a comprehensive vibration test program in order to evaluate the performance of Hilti fasteners in vibration. The tests were defined to simulate real application environments. The test concept was focused on vibration which may result in rotational loosening of nuts or other threaded elements such as the X-FCM grating fastener.

**Test concept and data collection**

To better understand the real-world vibration cases that are of concern to customers, real-world data was collected and testing hardware capabilities

were built up to evaluate product performance in realistic, relevant condition sets. Sensors were delivered to customer sites where vibration is present and installed in locations of interest. The sensors were left in place to collect data over 24-hour period. Afterwards, raw data was extracted from the sensors and processed at Hilti to provide acceleration vs. time signals, as well as dominant frequencies. In a final step data was converted into displacement and frequency parameters for different test setups depending on the relevant application.

### Fastener Systems and Applications

Fastener System	Application			
	Turbomachinery	Wind Turbine	Shaker / Conveyor	Grating Walkway
	S-BT-EF HL / -ER HL (Multi-Purpose Fastening MPF) S-BT-GF HL / -GR HL + X-FCM (Grating Fastening GF)			S-BT-GF HL / -GR HL + X-FCM (Grating Fastening GF)
Key parameters	<ul style="list-style-type: none"> <li>High frequency, low amplitude, periodic vibrations</li> <li>Dominant frequencies: 50 - 100 Hz</li> <li>Secondary frequencies: ~ 190 Hz</li> <li>Vibrations come from rotating elements + fluid/gas flow</li> </ul>	<ul style="list-style-type: none"> <li>Low frequency, high amplitude, periodic vibrations</li> <li>Dominant frequencies: 1 - 5 Hz</li> <li>Secondary frequencies: ~ 90 Hz</li> <li>Vibrations come from swaying of tower + rotation of blades</li> </ul>	<ul style="list-style-type: none"> <li>Medium frequency, medium amplitude, periodic vibrations</li> <li>Dominant frequencies: 10 - 30 Hz</li> <li>Secondary frequencies: ~ 110 Hz</li> <li>Vibrations come from shaking motion of transporter mechanism</li> </ul>	<ul style="list-style-type: none"> <li>Low frequency, medium amplitude, transient vibrations</li> <li>Foot traffic frequencies: ~ 2 Hz</li> <li>Additional vibration from surrounding machinery, turbines etc. subjects grating to various frequencies.</li> </ul>

Based on the data collected the below test plan was derived. Frequencies, amplitudes and installation torque correspond to real world application conditions.

### Test Plan

Test Type	Application									
	Turbomachinery			Wind Turbine			Shaker / Conveyor			Grating Walkway
Test Parameters	Base material vibration			Base material vibration			Base material vibration			Vibration of grating span
Test Parameters	Phase 1	Phase 2	Phase 3	Phase 1	Phase 2	Phase 3	Phase 1	Phase 2	Phase 3	Phase 1
Frequency [Hz]	50	100	193	1.1	3.3	86	10	30	109	12
Load cycles	30 min per phase n = 30*60*Frequency									65000
Amplitude [mm]	0.05	0.02	0.003	6.07	0.66	0.001	0.37	0.04	0.003	2
Installation torque [Nm]	8			8			8			5
Test setup MPF	25 kg point load on cantilever fastened with 2 S-BT HL fasteners to I-profile steel beam									N/A
Test setup GF	Grating sections fastened with S-BT HL + X-FCM to I-profile steel beam									2 m span of grating with 4 S-BT HL + X-FCM fasteners

MPF: Multi-Purpose Fastening GF: Grating Fastening

### Test Setup

(a) Multi-Purpose Fastening (MPF): Base material vibration testing

- Replication of periodic vibration of base material (steel beams).
- Evaluates performance of a threaded connection in a vibration-rich environment when a nearby source is causing the base material to oscillate.
- A cantilever connection is used as a representative MPF application, where a mass is fixed to the end of the lever arm.
- Performance of different S-BT-MF HL / -MR HL and serrated flange nut combinations are tested and evaluated.
- Each fastener is marked in order to observe any loosening that may occur from rotation of the screw element.
- Acceleration of the fastened element is monitored to observe if slip from loosening occurs.

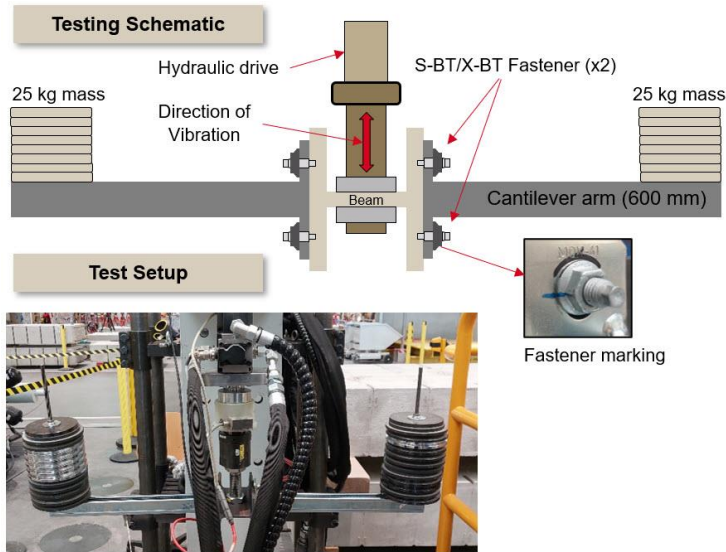

**Figure 2:** (a) Multi-Purpose Fastening (MPF): Base material vibration testing

(b) Grating Fastening (GF): Base material vibration testing

- Replication of periodic vibration of base material (steel beams).
- Evaluates the performance of a threaded connection in a vibration-rich environment when a nearby source is causing the base material to oscillate.
- 2 grating sections of pitch 33mm x 33mm are fastened to the upper flange on either side of the hydraulic arm fixing point using two fasteners each.
- 1 longer grating section of pitch 33mm x 33mm is positioned on the lower flange and fixed with two fasteners.
- Performance of the grating discs and S-BT HL threaded studs are tested to confirm that base material vibration is not the critical case of vibration for grating fastening.
- Each fastener is marked in order to observe any loosening that may occur from rotation of the screw element.

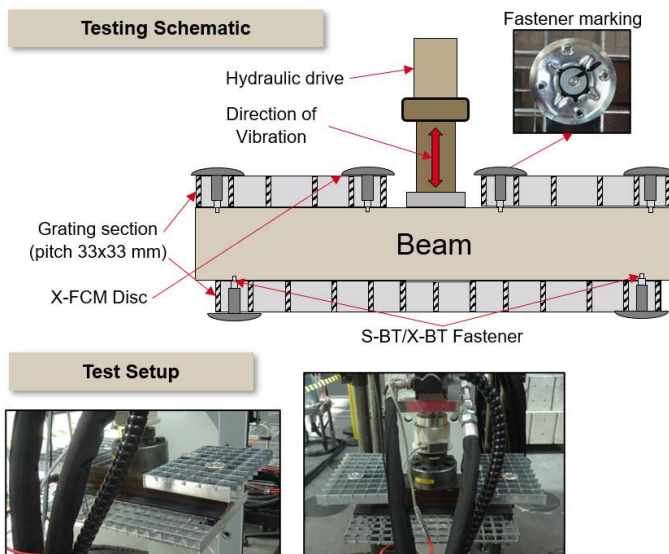

**Figure 3:** (b) Grating Fastening (GF): Base material vibration testing

(c) Grating Fastening (GF): Grating span testing

- Replication of person walking across grating
- A load is applied to the centre of a grating span repeatedly with a resultant displacement similar to that of an average person's footsteps.
- To evaluate a worst-case scenario a test is carried out at a frequency that generates the highest acceleration value (12 Hz).
- Pretension at a control sample is measured over the test duration.
- Each fastener is marked in order to observe any loosening that may occur from rotation of the screw element.
- The test is carried out with grating discs in combination with S-BT HL threaded studs
- Test parameters and duration equvalates to 400 days of medium traffic conditions (100 people per day).

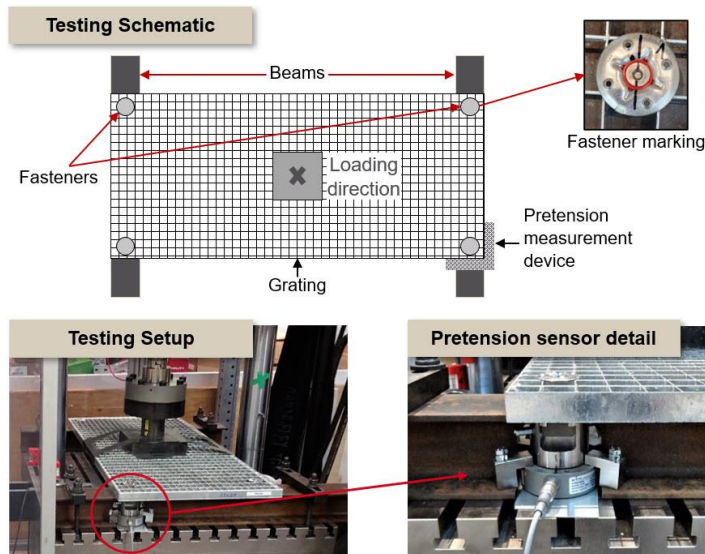

**Figure 4:** (c) Grating Fastening (GF): Grating span testing

**Test results**

**(a) Multi-Purpose Fastening (MPF): Base material vibration testing**

Fastener	Inspection	Evaluation
S-BT-MR HL + serrated flange nut (stainless steel)		<ul style="list-style-type: none"> <li>The base material vibrated with a behavior typical of the vibration environmental condition sets, in sequence.</li> <li>The 3 sub-phases of each environment condition set covered the range of frequency and amplitudes relevant to that specific environment.</li> <li>After each condition set the nut + S-BT HL fasteners were observed for signs of loosening.</li> <li>No loosening of the nut and no slip of the fastened cantilever was observed, showing good retention of pretension / clamping force.</li> </ul>
S-BT-MF HL + serrated flange nut (carbon steel)		

**(b) Grating Fastening (GF): Base material vibration testing**

Fastener	Inspection	Evaluation
S-BT-GR HL + X-FCM-R (stainless steel)		<ul style="list-style-type: none"> <li>The base material vibrated with a behavior typical of the vibration environmental condition sets, in sequence.</li> <li>The 3 sub-phases of each environment condition set covered the range of frequency and amplitudes relevant to that specific environment.</li> <li>After each condition set the X-FCM grating disc + S-BT HL fastener were observed for signs of loosening (rotation of disc).</li> <li>No loosening of the X-FCM grating disc + S-BT HL fastener and no slip of the fastened grating was observed, showing good retention of pretension / clamping force.</li> </ul>
S-BT-GF HL + X-FCM-F (carbon steel)		

**(c) Grating Fastening (GF): Grating span testing**

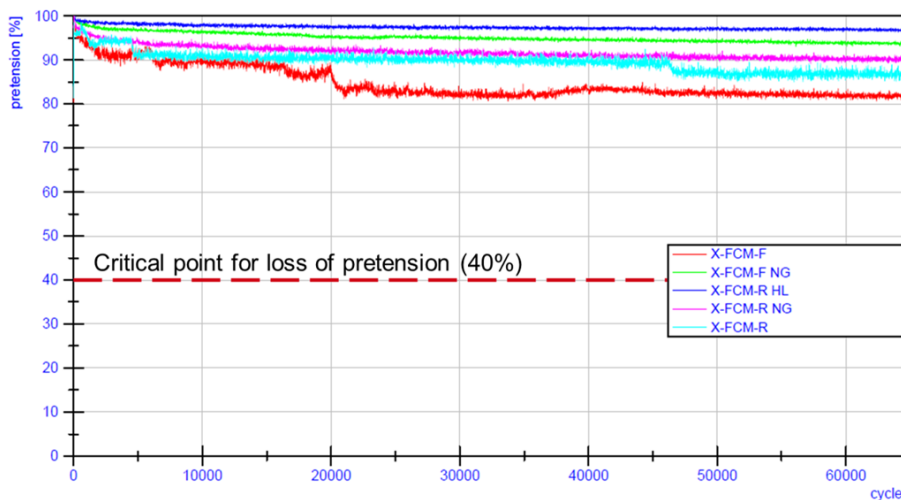

\* X-FCM-R HL tested with X-BT

- For all tested combinations (X-FCM-F / X-FCM-R discs with S-BT HL), pretension remains above 80%, showing a very high level of pretension retention.
- All recorded pretension curves show a horizontal profile at the end of the test with no indication of loosening over time.
- No rotation of the X-FCM grating disc was observed over the test duration.

**Conclusion**

Base material vibration:

The fasteners evaluated showed no signs of loosening under the tested conditions. The results indicate the suitability of S-BT-MR HL / -MF HL fasteners + provided serrated flange nuts (Multi-Purpose Fastening) and X-FCM-F / X-FCM-R grating disc + S-BT -GR HL / -GF HL to the covered environments.

Grating walkway (vibration of grating span):

The products tested showed their suitability to the transient loading of foot traffic that results in grating vibration.

**Note**

Tests focused on replicating vibration behaviour only and did not account for variances such as temperature.

Due to the complex range of potential vibration conditions, Hilti recommends continuation of the user's existing maintenance procedures and protocols regarding threaded assemblies.

This summary is intended to be representative of the test(s) carried out. It is not intended to be a full and complete test report.

#### 4.6 Resistance of S-BT HL fastenings under dynamic tensile loading

Report No. XSEhac-01-15\_06; Hilti AG; Schaan 2015  
 Additional tests with S-BT HL; Hilti AG; Schaan 2022

##### General comments

The tests were performed to investigate the effect of repeated tensile loads on the anchorage of the S-BT fastenings. Therefore, Wöhler charts for S-BT fastenings have been evaluated in view of the resistance of vibrations in axial direction (repeated tensile loads).

##### Test concept

The S-BT fasteners were subjected to a harmonic pulsating tensile loading. The minimal load of the harmonic loading was 0.2 kN in all tests. Tests were performed at 4 different load levels. The applied maximal loads were 1.8, 3.6, 4.5 and 5.4 kN. Tests were stopped if no failure occurred within 10 million load cycles. As a testing frequency 50 Hz were chosen. The tests were performed with steel base material S355 with an ultimate tensile strength  $f_u = 630$  MPa in combination with a minimum thread intersection of 0.2 mm. Minimum thread intersection is defined as the lowest tolerance field of the stud thread engagement with the base material.

##### Test results

	Level	# tests	$F_{max}$ [kN]	$F_{min}$ [kN]	$\sigma_{max}$ [N/mm <sup>2</sup> ]	$\sigma_{min}$ [N/mm <sup>2</sup> ]	$\sigma_{mean}$ [N/mm <sup>2</sup> ]	$\sigma_a$ [N/mm <sup>2</sup> ]	$\Delta\sigma$ [N/mm <sup>2</sup> ]	Ratio R	Cycles N	Fail	Pass
Stainless steel 1.4462	1	5	1.8	0,2	115	12.8	63.9	51.1	102.2	0.11	12'000'000		✓
											16'000'000		✓
											12'000'000		✓
											12'000'000		✓
											11'000'000		✓
	2	5	3.6	0,2	230	12.8	121.4	108.6	217.2	0.06	2'246'724	Rupture	
											11'706'502		✓
											12'675'924		✓
											10'000'000		✓
											10'000'000		✓
	3	5	4.5	0,2	288	12.8	150.4	137.6	275.2	0.04	294'040	Pull out	
											918'680	Pull out	
											4'655'463	Rupture	
											5'617'125	Pull out	
											9'38'2038	Rupture	
	4	5	5.4	0,2	346	12.8	179.4	166.6	333.2	0.04	1'775'555	Rupture	
											788'133	Rupture	
											620'386	Rupture	
											10'000'000		✓
											3'141'580	Rupture	

Test results of fatigue tests with S-BT fasteners (1.4462) loaded with harmonic pulsating tensile loads

At level 1 all samples passed the load level of 1.8 kN. At the second level 4 out of 5 samples passed the load level of 3.6 kN. Consequently, higher maximal loads were applied to increase the probability of failure. At level 3 and 4 the majority of the samples failed.

In all tests the governing failure mode was fatigue fracture of the S-BT stud or pull out from the base material.

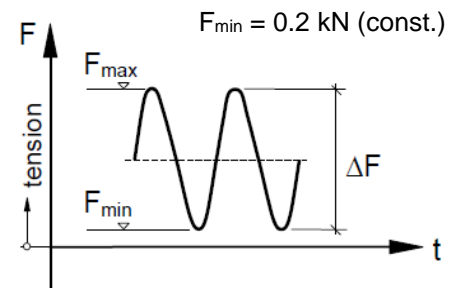
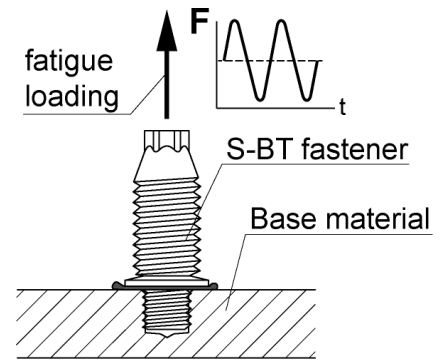

Principle sketch of cyclic tension tests

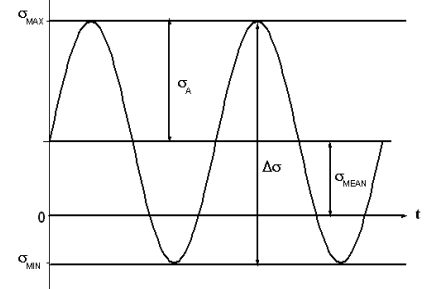

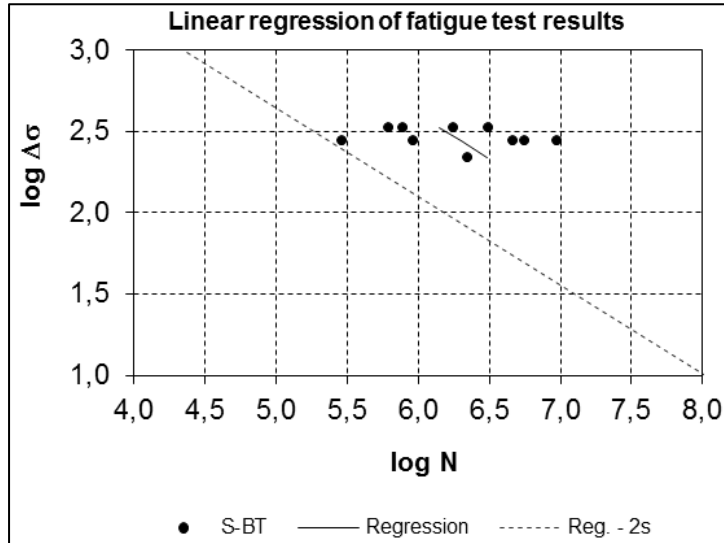

Linear regression of fatigue test results

As often done in fatigue design, the characteristic resistance  $\Delta\sigma_k$  (= 5%-fractile or 95% probability of survival) is assessed by reducing the linear regression with the double of the standard deviation “s” of the test data. “s” corresponds to the standard deviation of the difference between the test results and the mean trend.

Applying this procedure, the characteristic fatigue strength determines to:

$$\log N_k = 9.8626 - 1.8396 \cdot \log \Delta\sigma_k$$

Load $N_{rec}$ [kN]	Cycles $N_k$ [-]	$\Delta\sigma$ [N/mm <sup>2</sup> ]	log $\Delta\sigma$ [-]	log $N_k$ [-]	Comment
1.8	1'175'000	115	2.062	6.070	
2.3	748'000	147	2.168	5.874	
3.6	329'500	230	2.362	5.518	
4.3	237'500	275	2.439	5.376	$N_{rec} = 4.3$ kN for S355 / Grade 50 steel

Characteristic cycle life  $N_k$  at tension service load level  $N_{rec}$

### Conclusions

- The values given in the table can be used for fatigue design of the stainless-steel S-BT HL fasteners in steel grade S355 / Grade 50.
- In case fatigue design with higher load cycles beyond 1'175'000 cycles is required, the characteristic fatigue design curve (Reg. – 2s) can be conservatively used.
- The results presented allow the use of S-BT HL fasteners in applications, where wind suction is involved or to cover many typical "dynamic" parts of in principle static working loads.
- If high cycle fatigue design is necessary, the corresponding characteristics can be used to assess the principle suitability of S-BT HL fasteners for the specific purpose. Nevertheless, high cycle fatigue design is beyond the scope of the S-BT HL fasteners.

### Note:

- In case of static loading, sufficient redundancy of the entire fastening must be provided.



Hilti S-BT fastening system under cyclic loading



- The values stated apply for axial tensile loading. The constructive detail has to be checked with regards to this condition. If bending stresses – for example due to imperfections – might occur, these have to be considered in fatigue design. Imperfections will lead to a reduction of the characteristic cycle lives.
- The partial safety factors for fatigue actions as well as fatigue resistance have to be considered according to fatigue design provisions (for example: Eurocode 4 or AISC-LRFD) in agreement with the statistical evaluation of  $N_k$ .
- If global safety concepts are applied, the global factors of safety have to be taken in agreement with the statistical evaluation of  $N_k$  meeting the conditions of the used design standard.

This summary is intended to be representative of the test(s) carried out. It is not intended to be a full and complete test report.

#### 4.7 Effect of S-BT HL threaded stud fastenings on the fatigue strength of the base material structural steel

Report No. 2017-38X by Prof. U. Kuhlmann and Prof. H.-P. Günther from the University of Stuttgart: Fatigue classification of the constructional detail “Structural steel base material with Hilti S-BT screw-in threaded studs”, (2017) [5]

Report No. 2022-55X by Prof. U. Kuhlmann and Prof. H.-P. Günther from the University of Stuttgart: Hilti screw-in threaded studs S-BT HL (High Load), (2022) [6]

Report No. 5214011585/e, No. 5214013022/e\_corr. and 5214014601/e Swiss Federal Laboratories for Materials Science and Technology (2016 and 2017) [1], [2], and [3]

Report No. 5214029374/e

Swiss Federal Laboratories for Materials Science and Technology (2022) [4]

#### General comments

When using Hilti S-BT HL fasteners installed into structural steel elements that are subjected to cyclic loading, the effect of the fastener on the fatigue strength of the steel base material has to be considered. Hilti has completed a comprehensive fatigue test program in order to classify the constructional detail „Steel base material with Hilti S-BT HL screw-in threaded studs“ in compliance with different fatigue codes and standards, namely EN 1993-1-9 [7], AWS D1.1/D1.1M [8], ABS [9], BV [10], DNVGL-RP-C203 [11] and BS 7608 [12]. A corresponding evaluation was made by Prof. U. Kuhlmann and Prof. H.-P. Günther from the University of Stuttgart (Report No. 2017-38X, [5] and Report No. 2022-55X, [6]).

#### Test Concept

10 different test series were carried out varying the following parameters which can influence the fatigue resistance:

- 5 different plate thickness' ( $t = 3, 4, 6, 8$  and  $20$  mm),
- 2 different stress ratios ( $R = +0.1$  and  $+0.3$ ),
- 2 different installation conditions (correctly installed and fastener removed),
- 2 different fastener materials (stainless steel and carbon steel)

The steel base material was conservatively chosen to grade S235JR acc. to EN 10025-2, being aware that higher strength and fine grain steel show in general better fatigue resistance for non-welded details.

Name of series	Thickness t [mm]	Stress ratio R [-]	Installation condition	# of test specimens	Report
235-03-01-ci	3	+0.1	stud correctly installed	10	[2]
235-03-01-ci	3	+0.1	stud correctly installed	4*	[4]
235-04-01-ci	4	+0.1	stud correctly installed	10+2**	[1], [3]
235-04-01-io	4	+0.1	stud installed and overwound	7*	[3]
235-06-01-ci	6	+0.1	stud correctly installed	10	[1]
235-06-03-ci	6	+0.3	stud correctly installed	10	[3]
235-08-01-ci	8	+0.1	stud correctly installed	11+2**	[1], [2], [3]
235-08-01-ip	8	+0.1	stud installed and pulled out	9	[2]
235-08-03-ci	8	+0.3	stud correctly installed	6	[2]
235-20-01-ci	20	+0.1	stud correctly installed	10	[2]

Steel base material grade: S235JR  
 Fastener type: S-BT-MR M8/7 SN 6 (stainless steel)  
 \* Fastener type: S-BT-MR M8/7 SN 6 HL (stainless steel)  
 \*\* Fastener type: S-BT-MF M8/7 AN 6 (carbon steel)

**Table 1:** Overview of the test program

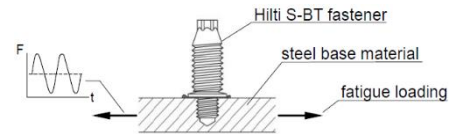

Hilti S-BT fastening system under cyclic loading

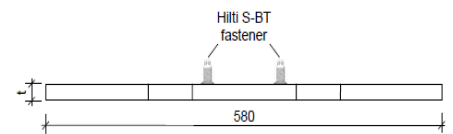
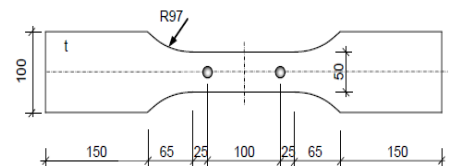

Shape and dimension of the test specimen

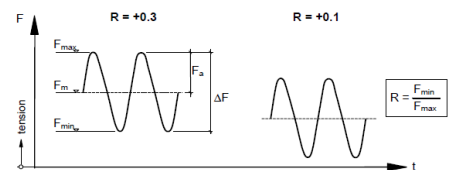

Loading condition of test specimens

**Test results and evaluation procedure**

The statistical evaluation of the test results and the final set-up of a fatigue reference class and S-N curve were done in three steps.

1. Determination of linear regression line (mean S-N curve) of fatigue test series
2. Determination of a characteristic design S-N curve with a certain probability of failure based on the requirements with regards to the statistical intervals (confidence level, probability of survival) as given in the specific codes and standards.
3. Recommendation of a final design S-N curve and fatigue reference class based on the afore mentioned statistical evaluation and engineering judgment considering the specific S-N curve types and classes as given in the relevant codes and standards.

Table 2 summarizes the results of a statistical evaluation acc. to EN 1993-1-9 combining all test results with regards to the base material thickness, stress ratio R, installation condition and fastener material.

Base material	Thickness t [mm]	Stress ratio R [-]	Installation*	No. of			Slope of S-N curve m [-]	Standard deviation s [-]	k-factor [-]	Fatigue strength at N = 2·10 <sup>6</sup>	
				test specimens	data points	run-outs				mean value Δσ <sub>m</sub> [N/mm <sup>2</sup> ]	detail category Δσ <sub>c</sub> [N/mm <sup>2</sup> ]
S235JR	3...20	0.1-0.3	ci, io, ip	83	79	4	5.17	0.373		136.3	102.0

\* ci...stud correct installed io...stud installed and overwound ip...stud installed and pulle-out

**Table 2:** Statistical evaluation combining all test results

In Figure 1, all test data and the statistically evaluated design S-N curve are plotted in comparison to the detail category 100 (m<sub>1</sub> = 5) as given in EN 1993-1-9 [7] and the IIW-Recommendations [13]. Both curves fit very well, which means that the fatigue strength of Hilti S-BT HL fastening system can be well described by the detail category 100 (m = 5).

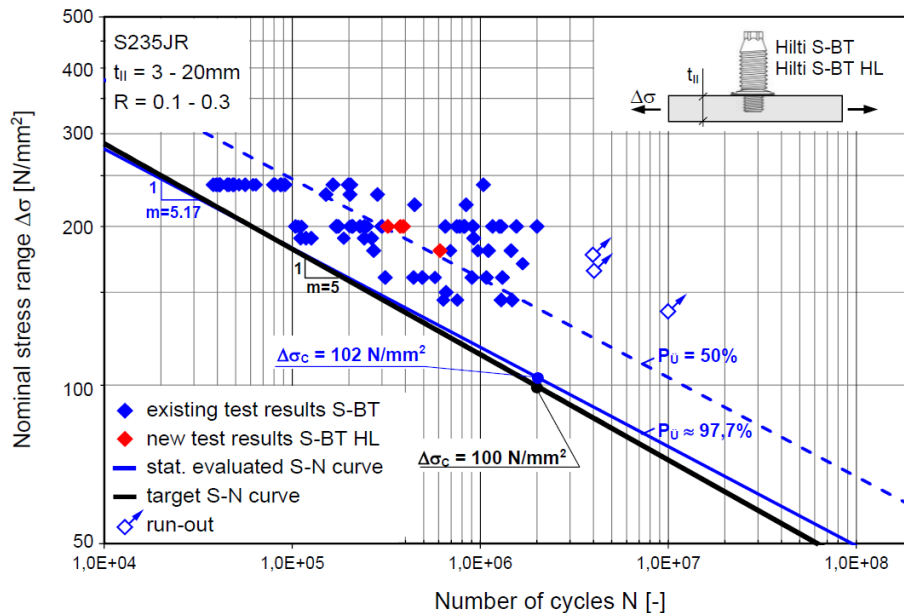

**Figure 1:** Statistical evaluation of all test results

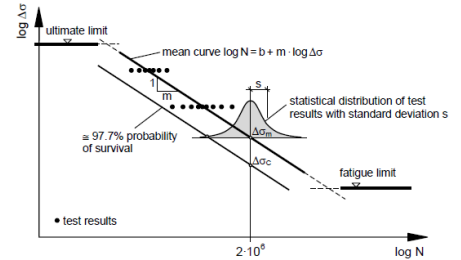

Statistical evaluation acc. to EN 1993-1-9 (EC 3)



Test facility for fatigue tests



Specimen for fatigue tests

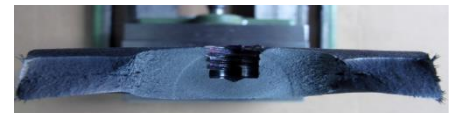

Fracture surface

**Recommendation of a design S-N curve according to different codes**

On the basis of the existing test results and a statistical evaluation of these test data according to the provisions given in EN 1993-1-9:2005 (Eurocode 3) it is recommended to use following general design S-N curve for the Hilti S-BT HL fastening system. The structural steel grades S235 up to S355 acc. to EN 10025-2, EN 10025-3 and EN 10225 are covered.

$$\log N = \log a - m \cdot \log S$$

with

log N                    logarithm to base 10 of corresponding number of cycles to failure N

log a = 16.300        intercept on the log N axis

m = 5.0                negative slope of S-N-curve being linear on a log-log basis

log S                    logarithm to base 10 of stress range  $\Delta\sigma$

Number of load cycles N	Stress range $\Delta\sigma$ [MPa]
1 · 10 <sup>5</sup>	181.9
1 · 10 <sup>6</sup>	114.8
2 · 10 <sup>6</sup>	100.0
5 · 10 <sup>6</sup>	83.2
1 · 10 <sup>7</sup>	72.4
1 · 10 <sup>8</sup>	45.7

**EN 1993-1-9:2005 (Eurocode 3)**

It is recommended to use the following design S-N curve respectively detail category given in Table 3 for the constructional detail “Steel base material with Hilti S-BT HL screw-in threaded studs”.

Detail category	Construction detail	Description	Requirements
100 m = 5		Hilti S-BT HL screw-in threaded studs with pre-drilled hole in structural steel base material. Imperfect fastener installations as e.g. overwound or pulled-out fasteners are covered.	$\Delta\sigma$ to be calculated by the gross cross section. Installation, static loading and spacing of the fasteners only in accordance with the requirements given in [1] or [2]. Base material thickness $t_{fl} \geq 3$ mm. Steel base material S235 up to S355 acc. to EN 10025-2 and EN 10025-3
<p>[1] Hilti S-BT HL screw-in threaded studs. Specification Binder. [2] Hilti Product Data Sheet S-BT HL.</p>			

**Table 3:** Recommendation of fatigue S-N curve and detail category acc. to EN 1993-1-9:2005

**AWS D1.1/D1.1M:2015**

It is recommended to use the following design S-N curve respectively stress category termed “S-BT” given in Table 4 and Figure 2 for the constructional detail “Steel base material with Hilti S-BT HL screw-in threaded studs”.

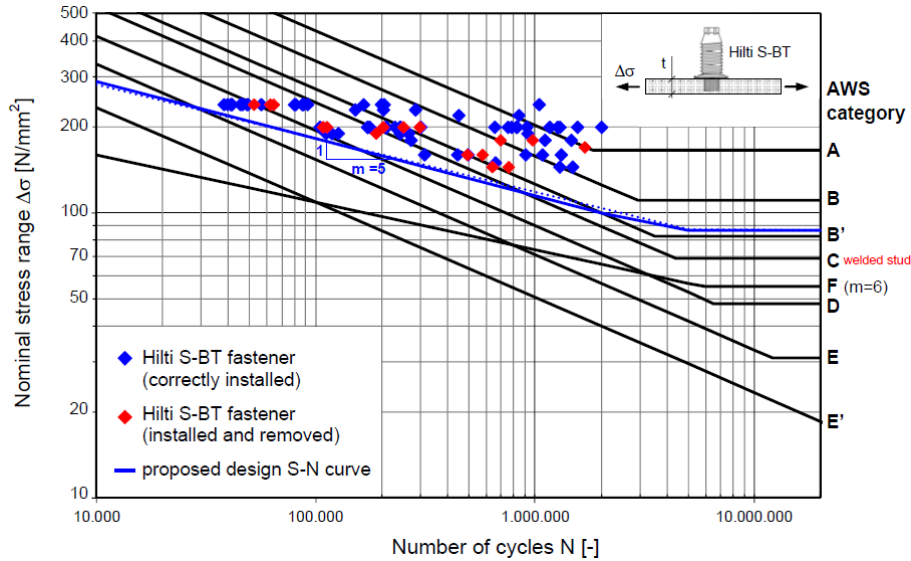

**Figure 2:** Comparison of Hilti S-BT HL fatigue test data with AWS D1.1/D1.1M:2015 fatigue categories and new proposed fatigue stress category “S-BT” for Hilti S-BT HL fastener

Stress Category	m	C <sub>f</sub> for [ksi]	C <sub>f</sub> x 329 for [MPa]	F <sub>TH</sub> [ksi]	F <sub>TH</sub> [MPa]
A	3.0	250 x 10 <sup>8</sup>	8.225 x 10 <sup>12</sup>	23.9	165.0
B	3.0	120 x 10 <sup>8</sup>	3.948 x 10 <sup>12</sup>	16.0	110.0
B'	3.0	61 x 10 <sup>8</sup>	2.007 x 10 <sup>12</sup>	12.0	83.0
C	3.0	44 x 10 <sup>8</sup>	1.448 x 10 <sup>12</sup>	10.0	69.0
D	3.0	22 x 10 <sup>8</sup>	7.238 x 10 <sup>11</sup>	7.0	48.0
E	3.0	11 x 10 <sup>8</sup>	3.619 x 10 <sup>11</sup>	4.5	31.0
E'	3.0	39 x 10 <sup>8</sup>	1.283 x 10 <sup>11</sup>	2.6	18.0
F	6.0	150 x 10 <sup>10</sup>	1.650 x 10 <sup>17</sup>	8.0	55.0
<b>S-BT</b>	<b>5.0</b>	<b>6065 x 10<sup>10</sup></b>	<b>1.995 x 10<sup>16</sup></b>	<b>12.6</b>	<b>87.0</b>

Description and requirements	Stress Category	Constant C <sub>f</sub> ksi [MPa]	Threshold F <sub>TH</sub> ksi [MPa]	Slope m	Potential crack initiation	Illustrative Example
Hilti S-BT screw-in stainless and carbon steel threaded studs with pre-drilled hole in structural steel base material. Imperfect fastener installations as e.g. overwound or pulled-out fasteners are covered. Δσ to be calculated by the gross cross-section. Installation, static loading and spacing of fasteners only in accordance with the requirements given in [1] or [2]. Plate thickness t ≥ 3 mm. Steel base material up to yield strength 355 MPa.	S-BT	6065x10 <sup>10</sup> [1.995x10 <sup>16</sup> ]	12.6 [87.0]	5.0	At the edge or tip of the pre-drilled hole	

**Table 4:** Recommendation of fatigue S-N curve and stress category acc. to AWS D1.1:2015

**ABS:2014**

It is recommended to use the following design S-N curve respectively stress category termed “S-BT” given in Table 5 and Figure 3 for the constructional detail “Steel base material with Hilti S-BT HL screw-in threaded studs”.

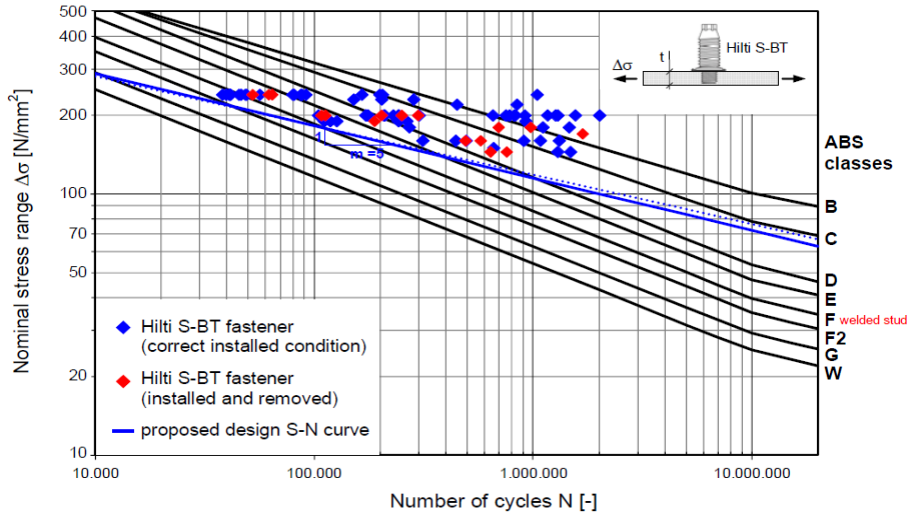

**Figure 3:** Comparison of Hilti S-BT fatigue test data with ABS-(A) Offshore S-N curves and new proposed fatigue class “S-BT” for Hilti S-BT HL fastener

Curve Class	A		m	r		N <sub>0</sub>	S <sub>0</sub>		
	for [MPa] units	for [ksi] units		for [MPa] units	for [ksi] units		for [MPa] units	for [ksi] units	
B	1.01x10 <sup>15</sup>	4.48x10 <sup>11</sup>	4.0	1.02x10 <sup>19</sup>	9.49x10 <sup>13</sup>	6.0	1.0x10 <sup>7</sup>	100.2	14.5
C	4.23x10 <sup>13</sup>	4.93x10 <sup>10</sup>	3.5	2.59x10 <sup>17</sup>	6.35x10 <sup>12</sup>	5.5	1.0x10 <sup>7</sup>	78.2	11.4
D	1.52x10 <sup>12</sup>	4.65x10 <sup>9</sup>	3.0	4.33x10 <sup>15</sup>	2.79x10 <sup>11</sup>	5.0	1.0x10 <sup>7</sup>	53.4	7.75
E	1.04x10 <sup>12</sup>	3.18x10 <sup>9</sup>	3.0	2.30x10 <sup>15</sup>	1.48x10 <sup>11</sup>	5.0	1.0x10 <sup>7</sup>	47.0	6.83
F	6.30x10 <sup>11</sup>	1.93x10 <sup>9</sup>	3.0	9.97x10 <sup>14</sup>	6.24x10 <sup>10</sup>	5.0	1.0x10 <sup>7</sup>	39.8	5.78
F2	4.30x10 <sup>11</sup>	1.31x10 <sup>9</sup>	3.0	5.28x10 <sup>14</sup>	3.40x10 <sup>10</sup>	5.0	1.0x10 <sup>7</sup>	35.0	5.08
G	2.50x10 <sup>11</sup>	7.64x10 <sup>8</sup>	3.0	2.14x10 <sup>14</sup>	1.38x10 <sup>10</sup>	5.0	1.0x10 <sup>7</sup>	29.2	4.24
W	1.60x10 <sup>11</sup>	4.89x10 <sup>8</sup>	3.0	1.02x10 <sup>14</sup>	6.54x10 <sup>9</sup>	5.0	1.0x10 <sup>7</sup>	25.2	3.66
<b>S-BT</b>	<b>1.995x10<sup>16</sup></b>	<b>1.28x10<sup>12</sup></b>	<b>5.0</b>	<b>1.995x10<sup>16</sup></b>	<b>1.28x10<sup>12</sup></b>	<b>5.0</b>	<b>1.0x10<sup>7</sup></b>	<b>72.4</b>	<b>10.50</b>

Description and notes on mode of failure	Class	Explanatory comments	Example including failure modes						
Hilti S-BT screw-in stainless and carbon steel threaded studs with pre-drilled hole in structural steel base material. Imperfect fastener installations as e.g. overwound or pulled-out fasteners are covered. Potential crack initiation at the edge or tip of the pre-drilled hole.	S-BT	Δσ to be calculated by the gross cross-section. Installation, static loading and spacing of fasteners only in accordance with the requirements given in [1] or [2]. Plate thickness t ≥ 3 mm. Steel base material up to yield strength 355 MPa.							
Parameter of design S-N curve class S-BT									
Curve Class	A		m	r		N <sub>0</sub>	S <sub>0</sub>		
	for [MPa] units	for [ksi] units		for [MPa] units	for [ksi] units		for [MPa] units	for [ksi] units	
S-BT	1.995x10 <sup>16</sup>	1.28x10 <sup>12</sup>	5.0	1.995x10 <sup>16</sup>	1.28x10 <sup>12</sup>	5.0	1.0x10 <sup>7</sup>	72.4	10.50

[1] Hilti S-BT HL screw-in threaded studs. Specification Binder.  
 [2] Hilti Product Data Sheet S-BT HL.

**Table 5:** Recommendation of fatigue S-N curve and fatigue class acc. to ABS-(A):2014

**BV:2016**

It is recommended to use the following design S-N curve respectively stress category termed “S-BT” given in Table 6 and Figure 4 for the constructional detail “Steel base material with Hilti S-BT HL screw-in threaded studs”.

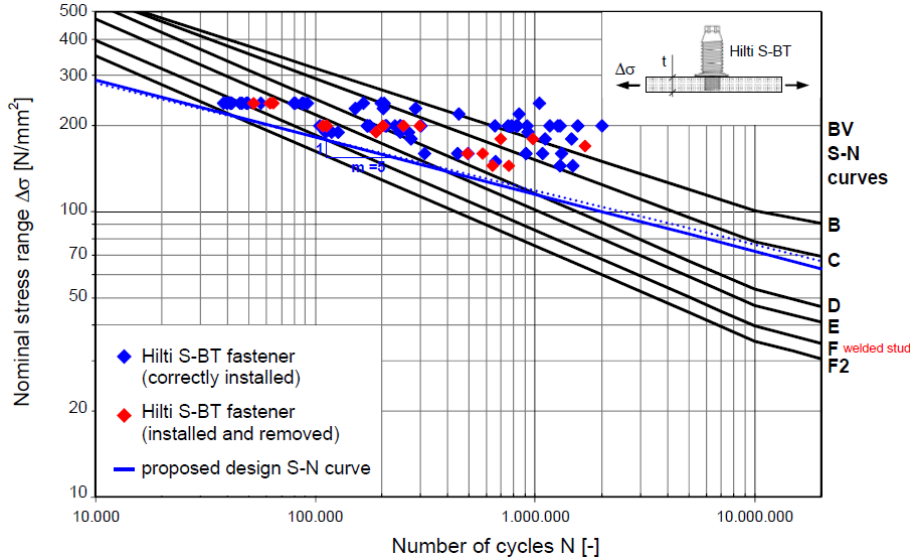

**Figure 4:** Comparison of Hilti S-BT fatigue test data with BV:2016 fatigue curves and new proposed fatigue curve “S-BT” for Hilti S-BT HL fastener

Curve	FAT	First slope		Slope intersection		Second slope		Reference thickness $t_{ref}$ [mm]	Thickness exponent n
	$\Delta S$ [MPa]	$m_1$	$\log_{10}(K_1)$	N cycles	$\Delta S_q$ [MPa]	$m_2$	$\log_{10}(K_2)$		
B	150.00	4.0	15.0056	$10^7$	100.32	7	21.0105	25	0
C	123.81	3.5	13.6260	$10^7$	78.19	6	18.3589		see Sec. 10, Tab. 2 of BV
D	91.25	3.0	12.18.18	$10^7$	53.36	5	15.6363		
E (1)	80.31	3.0	12.0153	$10^7$	46.96	5	15.3588		
F (1)	68.10	3.0	11.8004	$10^7$	39.82	5	15.0007		
F2 (1)	59.95	3.0	11.6345	$10^7$	35.06	5	14.7241		
P <sub>⊥</sub>	91.25	3.0	12.1818	$10^7$	53.36	5	15.6363		
P <sub>  </sub>	100.00	3.0	12.3010	$10^7$	58.48	5	15.8350		
<b>S-BT</b>	<b>100.00</b>	<b>5.0</b>	<b>16.3000</b>	<b><math>10^7</math></b>	<b>72.40</b>	<b>5</b>	<b>16.3000</b>	<b>25</b>	<b>0</b>

Joint and detail description	Curve	Geometry	Requirements
Hilti S-BT screw-in stainless and carbon steel threaded studs with pre-drilled hole in structural steel base material. Imperfect fastener installations as e.g. overwound or pulled-out fasteners are covered. Potential crack initiation at the edge or tip of the pre-drilled hole.	S-BT		$\Delta\sigma$ to be calculated by the gross cross-section. Installation, static loading and spacing of fasteners only in accordance with the requirements given in [1] or [2]. Plate thickness $t \geq 3$ mm. Steel base material up to yield strength 355 MPa.

Parameter of design S-N curve S-BT								
Curve	FAT	First slope		Slope intersection		Second slope		Thickness exponent n
	$\Delta S$ [MPa]	$m_1$	$\log_{10}(K_1)$	N cycles	$\Delta S_q$ [MPa]	$m_2$	$\log_{10}(K_2)$	
S-BT	100	5.0	16.300	$10^7$	72.40	5.0	16.300	0

[1] Hilti S-BT HL screw-in threaded studs. Specification Binder.  
 [2] Hilti Product Data Sheet S-BT HL.

**Table 6:** Recommendation of fatigue design S-N curve and stress category acc. to BV:2016, air

**DNV-RP-C203:2021**

It is recommended to use the following design S-N curve respectively stress category termed “S-BT” given in Table 7 and Figure 5 for the constructional detail “Steel base material with Hilti S-BT HL screw-in threaded studs”.

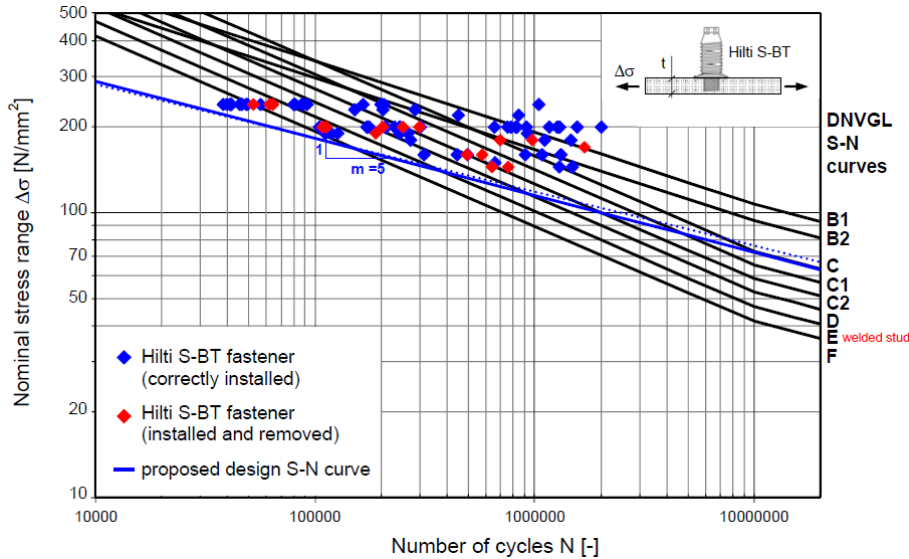

**Figure 5:** Comparison of Hilti S-BT fatigue test data with DNV-RP-C203:2021 fatigue curves and new proposed fatigue curve “S-BT” for Hilti S-BT HL fastener

S-N curve	N ≤ 10 <sup>7</sup> cycles		N > 10 <sup>7</sup> cycles log a <sub>2</sub> m <sub>2</sub> = 5.0	Fatigue limit at 10 <sup>7</sup> cycles [MPa]	Tickness exponent k
	m <sub>1</sub>	log a <sub>1</sub>			
B1	4.0	15.117	17.146	106.97	0
B2	4.0	14.885	16.858	93.59	0
C	3.0	12.592	16.320	73.10	0.05
C1	3.0	12.449	16.081	65.50	0.10
C2	3.0	12.301	15.835	58.48	0.15
D	3.0	12.164	15.606	52.63	0.20
E	3.0	12.010	15.350	46.78	0.20
F	3.0	11.855	15.091	41.52	0.25
F1	3.0	11.699	14.832	36.84	0.25
F3	3.0	11.546	14.576	32.75	0.25
<b>S-BT</b>	<b>5.0</b>	<b>16.300</b>	<b>16.300</b>	<b>72.4</b>	<b>0</b>

Detail category	Construction detail	Description	Requirements		
S-BT		Hilti S-BT screw-in stainless and carbon steel threaded studs with pre-drilled hole in structural steel base material. Imperfect fastener installations as e.g. overwound or pulled-out fasteners are covered.	Δσ to be calculated by the gross cross-section. Installation, static loading and spacing of fasteners only in accordance with the requirements given in [1] or [2]. Plate thickness t ≥ 3 mm. Steel base material up to yield strength 355 MPa.		
<b>Parameter of S-N curve for detail category S-BT</b>					
Detail category	N ≤ 10 <sup>7</sup> cycles		N > 10 <sup>7</sup> cycles log a <sub>2</sub>	Fatigue limit at 10 <sup>7</sup> cycles [MPa]	Thickness exponent k
S-BT	m <sub>1</sub>	log a <sub>1</sub>	m <sub>2</sub> = 5.0	72.4	0
	5.0	16.300	16.300		

[1] Hilti S-BT HL screw-in threaded studs. Specification Binder.  
[2] Hilti Product Data Sheet S-BT HL.

**Table 7:** Recommendation of fatigue S-N curve and detail category acc. to DNVGL-RP-C203, air



**BS 7608:2014**

It is recommended to use the following design S-N curve respectively stress category termed “S-BT” given in Table 8 and Figure 6 for the constructional detail “Steel base material with Hilti S-BT HL screw-in threaded studs”.

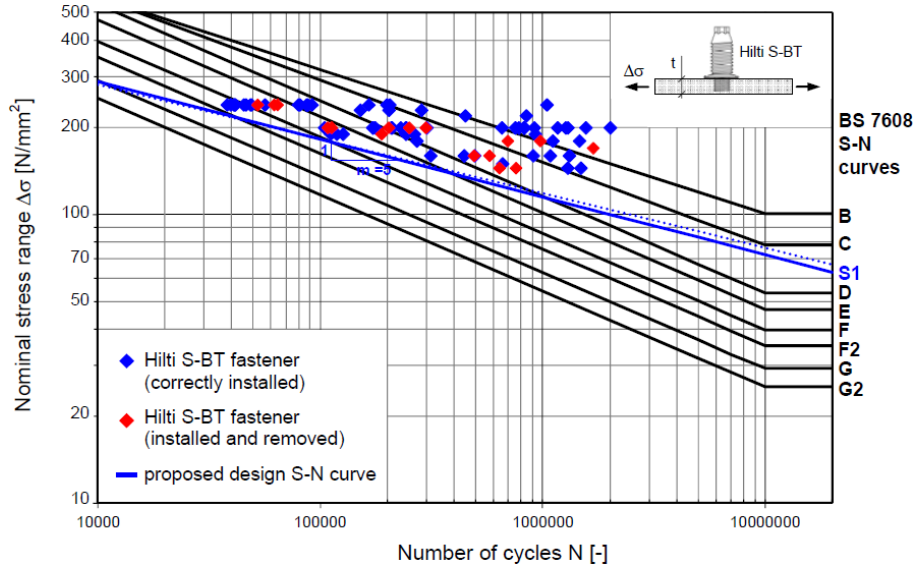

**Figure 6:** Comparison of Hilti S-BT fatigue test data with BS 7608:2014 fatigue curves and new proposed fatigue curve “S-BT” for Hilti S-BT HL fastener

Class	C <sub>0</sub>	log <sub>10</sub> C <sub>0</sub>	m	SD Stand. Deviation of log <sub>10</sub> N,	C <sub>2</sub>	S <sub>95c</sub> (N=10 <sup>7</sup> cyc.) N/mm <sup>2</sup>	S <sub>0y</sub> (N=5·10 <sup>7</sup> cyc.) N/mm <sup>2</sup>
B	2.343·10 <sup>15</sup>	15.3697	4.0	0.1821	1.01·10 <sup>15</sup>	100	67
C	1.082·10 <sup>14</sup>	14.0344	3.0	0.2041	4.23·10 <sup>13</sup>	78	49
D	3.988·10 <sup>12</sup>	12.6008	3.0	0.2095	1.52·10 <sup>12</sup>	53	31
E	3.2893·10 <sup>12</sup>	12.5171	3.0	0.2509	1.04·10 <sup>12</sup>	47	27
F	1.726·10 <sup>12</sup>	12.2371	3.0	0.2183	6.32·10 <sup>11</sup>	40	23
F2	1.231·10 <sup>12</sup>	12.0902	3.0	0.2279	4.31·10 <sup>11</sup>	35	21
G	5.656·10 <sup>11</sup>	11.7526	3.0	0.1793	2.48·10 <sup>11</sup>	29	17
G2	3.907·10 <sup>11</sup>	11.5918	3.0	0.1952	1.59·10 <sup>11</sup>	25	15
S1	5.902·10 <sup>16</sup>	16.7710	5.0	0.2350	2.00·10 <sup>16</sup>	46 (10 <sup>8</sup> cyc.)	46 (10 <sup>8</sup> cyc.)
S2	3.949·10 <sup>16</sup>	16.5965	5.0	0.3900	6.55·10 <sup>15</sup>	37 (10 <sup>8</sup> cyc.)	37 (10 <sup>8</sup> cyc.)
<b>S-BT</b>	<b>5.902·10<sup>16</sup></b>	<b>16.7710</b>	<b>5.0</b>	<b>0.2350</b>	<b>2.00·10<sup>16</sup></b>	<b>74.2</b>	<b>52.5</b>

Design S-N curve:  $\log N = \log_{10}C_0 - 2 \cdot SD - m \cdot \log S$

Product form	Location of crack	Detail	Manufacturing requirements	Special requirements	Design stress area	Class	Notes	Sketch
Rolled steel plates and sections	At the edge or tip of the pre-drilled hole	Hilti S-BT screw-in stainless and carbon steel threaded studs with pre-drilled hole in structural steel base material.	Installation, static loading and spacing of fasteners only in accordance with the requirements given in [1] or [2].	Plate thickness $t \geq 3\text{mm}$ . Steel base material up to yield strength 355 MPa.	Net cross section	S-BT (S1)	Imperfect fastener installations as e.g. overwound or pulled-out fasteners are covered.	

Parameter of S-N curve for detail class S-BT							
Class	C <sub>0</sub>	log <sub>10</sub> C <sub>0</sub>	m	SD Stand. Deviation of log <sub>10</sub> N	C <sub>2</sub>	S <sub>95c</sub> (N=10 <sup>7</sup> cyc.) N/mm <sup>2</sup>	S <sub>0y</sub> (N=5·10 <sup>7</sup> cyc.) N/mm <sup>2</sup>
S-BT	5.902·10 <sup>16</sup>	16.7710	5.0	0.2350	2.00·10 <sup>16</sup>	74.2	52.5

[1] Hilti S-BT HL screw-in threaded studs. Specification Binder.

[2] Hilti Product Data Sheet S-BT HL.

**Table 8:** Recommendation of fatigue S-N curve and detail category acc. to BS 7608:2014

**Literature:**

- [1] EMPA: Test Report No. 5214011585/e. Swiss Federal Laboratories for Materials Testing and Research (EMPA), April 26<sup>th</sup> 2016.
- [2] EMPA: Test Report No. 5214013022/e\_corr. Swiss Federal Laboratories for Materials Testing and Research (EMPA), June 29<sup>th</sup> 2017.
- [3] EMPA: Test Report No. 5214014601/e. Swiss Federal Laboratories for Materials Testing and Research (EMPA), April 11<sup>th</sup> 2017.
- [4] EMPA: Test Report No. 5214029374/e. Swiss Federal Laboratories for Materials Testing and Research (EMPA), November 7<sup>th</sup> 2022.
- [5] Kuhlmann, U., Günther, H.-P.: Fatigue classification of the constructional detail "Structural steel base material with Hilti S-BT screw-in threaded studs". Universität Stuttgart, Institut für Konstruktion und Entwurf, June 30<sup>th</sup>, 2017, Nr. 2017-38X.
- [6] Kuhlmann, U., Günther, H.-P.: Hilti screw-in threaded studs S-BT HL (High Load). Universität Stuttgart, Institut für Konstruktion und Entwurf, November 10<sup>th</sup> 2022, Nr. 2022-55X.
- [7] EN 1993-1-9: Eurocode 3: Design of steel structures - Part 1-9: Fatigue, European Committee for Standardization.
- [8] AWS D1.1: Structural Welding Code – Steel, American Welding Society.
- [9] ABS: Guide for Fatigue Assessment of Offshore Structures. American Bureau of Shipping. 2003, Updated version February 2014.
- [10] BV: Guidelines for Fatigue Assessment of Steel Ships and Offshore Units. Bureau Veritas. September 2016.
- [11] DNV-RP-C203: Recommended Practice – Fatigue design of offshore steel structures. Det Norske Veritas. Edition 2019-09 – Amended 2021-09.
- [12] BS 7608: Guide to fatigue design and assessment of steel products.
- [13] IIW: Hobbacher, A.: Fatigue recommendations for fatigue design of welded joints and components. International Institute of Welding (IIW), XIII-1539-96 / XV-845-95 document, May 2007.

**4.8 S-BT-ER (HC) HL and S-BT-EF (HC) HL screw-in threaded studs for electrical connections**

**Fasteners**

S-BT-ER M10/15 SN 6 HL  
 S-BT-ER W10/15 SN 6 HL  
 S-BT-EF M10/15 AN 6 HL  
 S-BT-EF W10/15 AN 6 HL

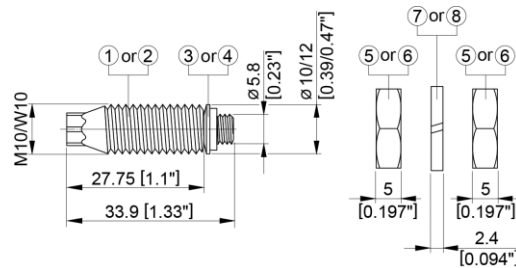

S-BT-ER M8/15 SN 6 HL  
 S-BT-EF M8/15 AN 6 HL

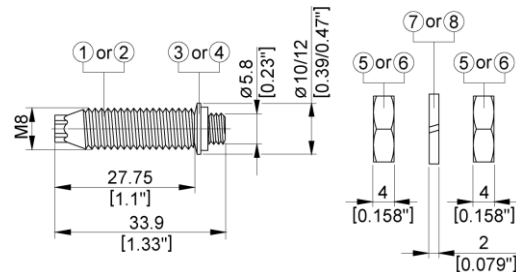

S-BT-ER M10 HC 120 HL  
 S-BT-ER W10 HC 4/0 HL  
 S-BT-EF M10 HC 120 HL  
 S-BT-EF W10 HC 4/0 HL

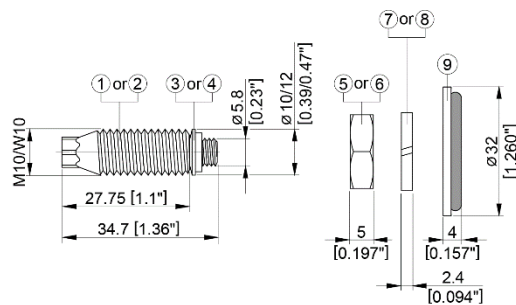

**Report No. 17-IK-0093.S02:** Suitability of Hilti S-BT-ER, S-BT-EF threaded studs as connection point in protective grounding and earthing circuits and for lighting protection; Electrosuisse, Fehraltorf, Switzerland; July 2017

**Report No. 17-IK-0021.S04:** Suitability of Hilti S-BT-EF/-ER M10 HC 35, ...W10 AWG2 and S-BT-EF/-ER M10 HC 120, ..W10 AWG4/0 threaded studs as connection point in protective grounding and earthing circuits and for lighting protection; Electrosuisse, Fehraltorf, Switzerland; August 2018

**Test Report No. FRM-1648, FRM-1649, FRM-1650**

Dehn + Söhne GmbH + Co.KG., Neumarkt, Germany; March 2017

**Test Report No. FRM-1795**

Dehn + Söhne GmbH + Co.KG., Neumarkt, Germany; June 2018

**Test Report No. FRM-1689**

Dehn + Söhne GmbH + Co.KG., Neumarkt, Germany; June 2017

**Test Report No. FRM-1798 and PAM-1834**

Dehn + Söhne GmbH + Co.KG., Neumarkt, Germany; May 2018 July 2018

**Test Report No. FRM-1689;** Dehn + Söhne GmbH + Co.KG., Neumarkt, Germany; June 2017

**Test Report No. 2276\_FRM;** DEHN SE, Neumarkt, Germany; December 2022

**Test Report No. 2331\_FRM;** DEHN SE, Neumarkt, Germany; April 2023

**Test Report No. 2453\_FRM**; DEHN SE, Neumarkt, Germany; November 2023

**UL-listing** (File E257069)

#### 4.8.1 Effect of S-BT-ER HL / S-BT-EF HL studs on integrity of pipe flange

Installation of a Hilti S-BT-ER HL / S-BT-EF HL threaded stud is not expected to have negative influence on the integrity of flanged pipe joints made from typical ductile steel materials, when installed in the center of the radial or flat face of the flange ring between two bolts.

Hilti's recommendations for edge distance, spacing, minimum flange diameter and minimum base material thickness, as well as Hilti's printed literature, must be considered during design and installation.

- Outer diameter of pipe flange is
  - greater than or equal to 150 mm (6 inches) for installation in the radial face
  - greater than or equal to 100 mm (4 inches) for installation in the flat face
- Minimum edge distance = 6 mm
- Minimum pipe flange thickness = 12 mm (installation in radial flange face)
- Minimum pipe flange thickness = 6 mm (installation in flat flange face)
- S-BT-ER HL / S-BT-EF HL installed on center of pipe flange and between 2 tension bolts

Only Type A cable connections are allowed to be installed in pipe flanges. Type B cable connections are not suitable for this application.

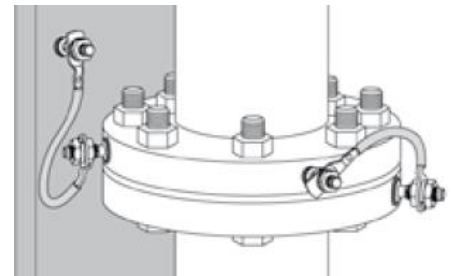

Functional and protective bonding of pipes  
(outer diameter of installed surface  $\geq 150\text{mm}$ )

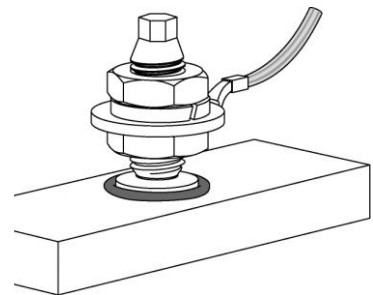

Type A cable connection

### 4.8.2 Permanent current

For permanent current (leakage current) due to static charge built up in pipes or when closing an electrical circuit.

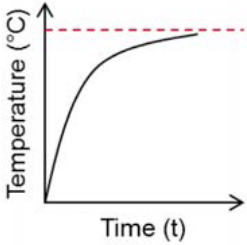
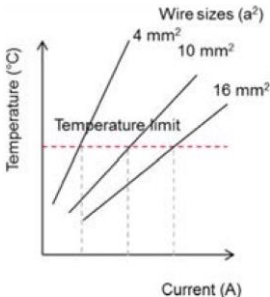
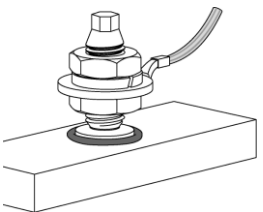
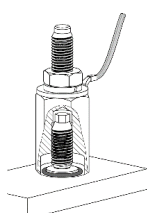
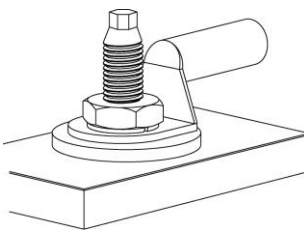
Test standard	Requirements or Test criteria
<p>IEC 60947-7-1 IEC 60947-7-2</p>	<p>The temperature of the fastening point should not exceed the limits of the cable under permanent current, e.g. 45 °C for PVC cables. Test duration: till stable temperature is reached.</p> <div style="display: flex; justify-content: space-around;">   </div>
Tested configuration	Fasteners
 <p>Single point connection, Type A</p>	<p>S-BT-ER M10/15 SN 6 HL S-BT-ER W10/15 SN 6 HL S-BT-EF M10/15 AN 6 HL S-BT-EF W10/15 AN 6 HL S-BT-ER M8/15 SN 6 HL S-BT-EF M8/15 AN 6 HL</p>
 <p>Single point connection with Hilti standoff adapter</p>	<p>S-BT-ER M10/15 SN 6 HL with Hilti standoff adapter M10-MR S-BT-ER W10/15 SN 6 HL with Hilti standoff adapter W10-MR S-BT-ER M8/15 SN 6 HL with Hilti standoff adapter M8-MR</p> <p>S-BT-ER M10/15 SN 6 HL with Hilti standoff adapter M10 HC120 S-BT-ER W10/15 SN 6 HL with Hilti standoff adapter W10 HC4/0</p>
 <p>Single point connection, Type B</p>	<p>S-BT-ER M10 HC 120 HL S-BT-ER W10 HC 4/0 HL S-BT-EF M10 HC 120 HL S-BT-EF W10 HC 4/0 HL</p>

### Conclusions:

- Recommended maximal cross section of connected cable according **IEC 60947-7-2 and IEC 60947-7-1**:  
10 mm<sup>2</sup> (8 AWG) copper (tested permanent current  $I_{th} = 57$  A)  
120 mm<sup>2</sup> (4/0 AWG) copper (tested permanent current  $I_{th} = 269$  A)
- Fastening of thicker cable is acceptable, if the maximum allowable permanent current  $I_{th}$  is not exceeded and the provisions on cable lug thickness  $t_{cl}$  are observed.

**4.8.3 Short circuit current**

For discharging short circuit current while protecting electrical equipment or earth / ground cable trays and ladders.

Test standards	Requirements or Test criteria
IEC 60947-7-1 IEC 60947-7-2	A grounding connection must be capable of withstanding a high test current ( $I_{test}$ ) for an exposure time of 1 second. $I_{test} = A_{cable} [mm^2] \times 120 [A/mm^2]$ where $A_{cable}$ = cross sectional area of the attached cable, exposure time 1 second i.e. for wire size 10 mm <sup>2</sup> , a current of 1200 A for 1 sec

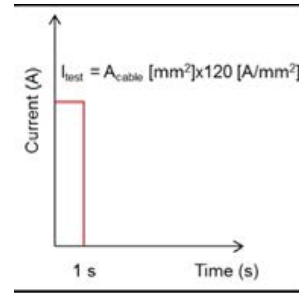

UL 467	A grounding connection must be capable of withstanding a high test current ( $I_{test}$ ) for an exposure time of 4 sec (10 AWG) or 9 sec (4/0 AWG).
--------	--

Fasteners	
	S-BT-ER M10/15 SN 6 HL S-BT-ER W10/15 SN 6 HL S-BT-EF M10/15 AN 6 HL S-BT-EF W10/15 AN 6 HL S-BT-ER M8/15 SN 6 HL S-BT-EF M8/15 AN 6 HL

Single point connection, Type A

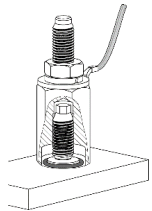
	S-BT-ER M10/15 SN 6 HL with Hilti standoff adapter M10-MR S-BT-ER W10/15 SN 6 HL with Hilti standoff adapter W10-MR S-BT-ER M8/15 SN 6 HL with Hilti standoff adapter M8-MR
---	---

Single point connection with Hilti standoff adapter

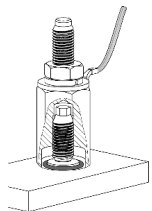
	S-BT-ER M10/15 SN 6 HL with Hilti standoff adapter M10-HC120 S-BT-ER W10/15 SN 6 HL with Hilti standoff adapter W10-HC4/0
---	--

Single point connection with Hilti High Current standoff adapter M10 HC120 or W10 HC4/0

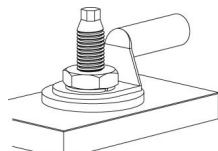
	S-BT-ER M10 HC 120 HL S-BT-ER W10 HC 4/0 HL S-BT-EF M10 HC 120 HL S-BT-EF W10 HC 4/0 HL
---	--

Single point connection, Type B

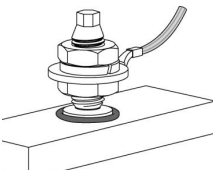
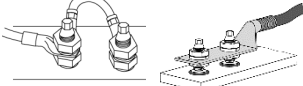
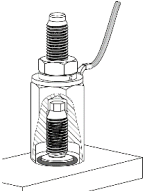
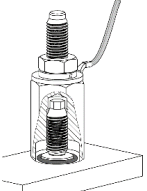
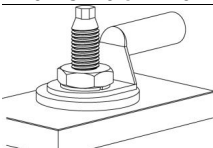
Tested configuration	Test results		
	Short circuit current $I_{cw}$	Exposure time $t_d$	Result
 Single point connection, Type A	1.20 kA (IEC) 0.75 kA (UL)	1 s 4 s	pass
 Double point connection, Type A	1.92 kA (IEC)	1 s	pass
 Single point connection with Hilti standoff adapter	1.20 kA (IEC) 0.75 kA (UL)	1 s 4 s	pass
 Single point connection with Hilti High Current standoff adapter M10 HC120 or W10 HC4/0	14.40 kA (IEC) 10.10 kA (UL)	1 s 9 s	pass
 Single point connection, Type B	14.40 kA (IEC) 10.10 kA (UL)	1 s 9 s	pass

**Conclusions:**
**Single point connection:**

- Recommended maximal cross section of connected cable according **IEC 60947-7-2 and IEC 60947-7-1**:  
 10 mm<sup>2</sup> (8 AWG) copper (tested short circuit current  $I_{cw} = 1.20$  kA for 1 s)  
 120 mm<sup>2</sup> (4/0 AWG) copper (tested short circuit current  $I_{cw} = 14.40$  kA for 1 s)  
 according **UL 467**:  
 10 AWG copper (tested short circuit current  $I_{cw} = 0.75$  kA for 4 s)  
 4/0 AWG copper (tested short circuit current  $I_{cw} = 10.10$  kA for 9 s)
- Fastening of thicker cable is acceptable, if the maximum short circuit current  $I_{cw}$  and the exposure time is not exceeded and the provisions on cable lug thickness  $t_{cl}$  are observed.

**Double point connection:**

- Recommended maximal cross section of connected cable according **IEC 60947-7-2 and IEC 60947-7-1**:  
 16 mm<sup>2</sup> (6 AWG) copper (tested short circuit current  $I_{cw} = 1.92$  kA for 1 s)
- Fastening of thicker cable is acceptable, if the maximum short circuit current  $I_{cw}$  and the exposure time is not exceeded and the provisions on cable lug thickness  $t_{cl}$  are observed

#### 4.8.4 Lightning current

For high temporary current due to lightning.

Test standards	Requirements or Test criteria
IEC 62561-1:2023 (Edition 3.0)	Electrical test with stress of 3 times 50 kA or 100 kA (signal form 10/350 $\mu$ s) lightning current as follows: <ul style="list-style-type: none"> <li>• Classification N <math>I_{imp} = 50 \text{ kA} \pm 10 \%</math>, <math>W/R = 0.625 \text{ MJ}/\Omega \pm 35 \%</math>, <math>t_d \leq 5 \text{ ms}</math></li> <li>• Classification H <math>I_{imp} = 100 \text{ kA} \pm 10 \%</math>, <math>W/R = 2.5 \text{ MJ}/\Omega \pm 35 \%</math>, <math>t_d \leq 5 \text{ ms}</math></li> </ul>
	<ul style="list-style-type: none"> <li>• Conditioning / ageing of the test samples</li> <li>• Test with three lightning impulse currents</li> <li>• Evaluation of mechanical strengths of test samples</li> <li>• Measurement of the contact resistance</li> <li>• Measurement of the loosening torque</li> </ul>

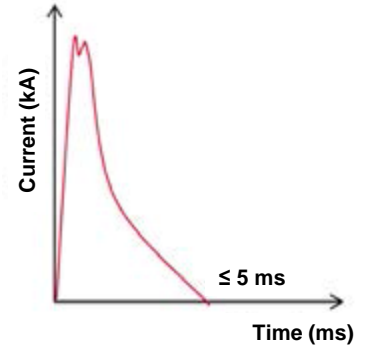

#### Fasteners

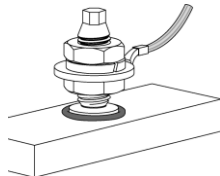

Single point connection, Type A

- S-BT-ER M10/15 SN 6 HL
- S-BT-ER W10/15 SN 6 HL
- S-BT-EF M10/15 AN 6 HL
- S-BT-EF W10/15 AN 6 HL
- S-BT-ER M8/15 SN 6 HL
- S-BT-EF M8/15 AN 6 HL

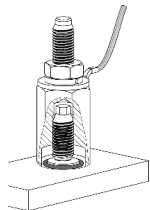

Single point connection with Hilti standoff adapter

- S-BT-ER M10/15 SN 6 HL with Hilti standoff adapter M10-MR
- S-BT-ER W10/15 SN 6 HL with Hilti standoff adapter W10-MR
- S-BT-ER M8/15 SN 6 HL with Hilti standoff adapter M8-MR

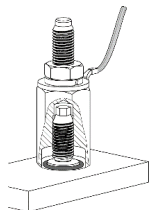

Single point connection with Hilti High Current standoff adapter M10 HC120 or W10 HC4/0



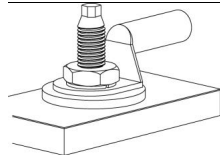

- S-BT-ER M10/15 SN 6 HL with Hilti standoff adapter M10 HC120
- S-BT-ER W10/15 SN 6 HL with Hilti standoff adapter W10 HC4/0





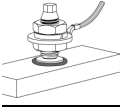

Single point connection, Type B

- S-BT-ER M10 HC 120 HL
- S-BT-ER W10 HC 4/0 HL
- S-BT-EF M10 HC 120 HL
- S-BT-EF W10 HC 4/0 HL

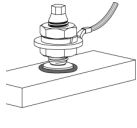

Tested configuration	Test results				
<b>Classification N</b> 	Current $I_{imp}$	Specific energy W/R	Exposure time $t_d$	Contact resistance $R_c$	Result
	50 kA	< 0.844 MJ/ $\Omega$ > 0.406 MJ/ $\Omega$	1 ms	< 1 m $\Omega$	pass
 S-BT-ER with Hilti standoff adapter	50 kA	< 0.844 MJ/ $\Omega$ > 0.406 MJ/ $\Omega$	1 ms	< 1 m $\Omega$	pass
<b>Classification H</b> 	Current $I_{imp}$	Specific energy W/R	Exposure time $t_d$	Contact resistance $R_c$	Result
	100 kA	< 3.38 MJ/ $\Omega$ > 1.63 MJ/ $\Omega$	1 ms	< 1 m $\Omega$	pass
 S-BT-ER with Hilti High Current standoff adapter M10 HC120 or W10 HC4/0	100 kA	< 3.38 MJ/ $\Omega$ > 1.63 MJ/ $\Omega$	1 ms	< 1 m $\Omega$	pass

**Conclusions:**

Based on IEC 62561-1:2023 (Edition 3.0):			
Classification	Exposure time	Fastener	Connection configuration
<b>Classification N</b> $I_{imp} \leq 50$ kA	1 ms	S-BT-ER M10/15 SN 6 HL S-BT-ER W10/15 SN 6 HL S-BT-EF M10/15 AN 6 HL S-BT-EF W10/15 AN 6 HL S-BT-ER M8/15 SN 6 HL S-BT-EF M8/15 AN 6 HL 	
		S-BT-ER M10/15 SN 6 HL with Hilti standoff adapter M10-MR S-BT-ER W10/15 SN 6 HL with Hilti standoff adapter W10-MR S-BT-ER M8/15 SN 6 HL with Hilti standoff adapter M8-MR 	
<b>Classification H</b> $I_{imp} \leq 100$ kA	1 ms	S-BT-ER M10 HC 120 HL S-BT-ER W10 HC 4/0 HL S-BT-EF M10 HC 120 HL S-BT-EF W10 HC 4/0 HL 	
		S-BT-ER M10/15 SN 6 HL with Hilti standoff adapter M10 HC120 S-BT-ER W10/15 SN 6 HL with Hilti standoff adapter W10 HC4/0 	

## 4.9 Corrosion resistance

### 4.9.1 Selection of a suitable fastener

If a fastening has to be perfectly satisfactory and reliable for its entire service life, all surrounding conditions must be ascertained before a suitable fastener can be selected.

Therefore, it is necessary to take into account where the parts are installed, indoor or outdoor. For outdoor applications, a distinction is made between rural, urban, industrial and marine atmospheres. Nevertheless, there are special applications like waste water treatment plants, industrial installations, road tunnels and swimming pools. In view of this, each application must be evaluated separately and the findings must be considered when selecting a material with the required corrosion behavior or a system that provides adequate corrosion protection.

When material combinations are used, an evaluation of their electrochemical behavior has to be performed to avoid contact corrosion.

**Note:**

- The information in the following section may be of assistance as it provides some important points that aid selection. The table, however, cannot cover all individual aspects for each application.
- The ultimate decision on the required corrosion protection must be made by the customer. Hilti accepts no responsibility regarding the suitability of a product for a specific application, even if informed of the application conditions. The tables are based on an average service life for typical applications. For metallic coatings, e.g. zinc layer systems, the end of lifetime is the point at which red rust is visible over a large fraction of the product and widespread structural deterioration can occur – the initial onset of rust may occur sooner.

		Fastener	
		Carbon steel <sup>1), 2)</sup>	Stainless steel
		S-BT-MF HL S-BT-MF MT HL S-BT-GF HL S-BT-EF (HC) HL	S-BT-MR HL S-BT-GR HL S-BT-ER (HC) HL
Coating / material		Duplex-coated carbon steel	A4 AISI 316
Environmental conditions	Fastened part		
Dry indoor	Steel (zinc-coated, painted), aluminum, stainless steel	■	■
Indoor with temporary condensation	Steel (zinc-coated, painted), aluminum stainless steel	■ <sup>2)</sup> -	■
Outdoor with low pollution	Steel (zinc-coated, painted), aluminum stainless steel	□ <sup>1), 2)</sup> -	■
Outdoor with moderate concentration of pollutants 1-10km	Steel (zinc-coated, painted), aluminum stainless steel	□ <sup>1), 2)</sup> -	■
Coastal areas 0-1km	Steel (zinc-coated, painted), aluminum, stainless steel	-	■
Outdoor, areas with heavy industrial pollution	Steel (zinc-coated, painted), aluminum, stainless steel	-	■
Close proximity to roads	Steel (zinc-coated, painted), aluminum, stainless steel	-	■
Special applications	Consult experts		

■ = expected lifetime of S-BT HL fasteners made from this material is typically satisfactory in the specified environment based on the typically expected lifetime of a building.

□ = a decrease in the expected lifetime of non-stainless fasteners in these atmospheres must be taken into account (≤ 25 years). Higher expected lifetime needs a specific assessment.

- = S-BT HL fasteners made from this material are not suitable in the specified environment. Exceptions need a specific assessment.

<sup>1)</sup> From a technical point of view, duplex coatings are suitable for outdoor environments with certain lifetime and application restrictions. This is based on long-term experience with these materials as reflected e.g. in the corrosion rates for Zn given in the ISO 9224:2012 (corrosivity categories, C-classes).

<sup>2)</sup> ETA-23/0001 allows the use of carbon steel threaded studs with duplex coating only in dry indoor environment (C1 acc. to EN ISO 9223).

**Important notes:**

National or international codes, standards or regulations, customer and/or industry specific guidelines must be independently considered and evaluated. These guidelines apply to atmospheric corrosion only. Special types of corrosion, such as crevice corrosion must be independently evaluated.

The tables published in this brochure describe only a general guideline for commonly accepted applications in typical atmospheric environments.

Suitability for a specific application can be significantly affected by localized conditions, including but not limited to:

- Elevated temperatures and humidity
- High levels of airborne pollutants
- Direct contact with corrosive products, such as found in some types of chemically-treated wood, waste water, concrete additives, cleaning agents, etc.
- Direct contact to soil, stagnant water
- Direct contact to fresh/young concrete (less than 28 days old)
- Electrical current
- Contact with dissimilar metals
- Confined areas, e.g. crevices
- Physical damage or wear
- Extreme corrosivity due to combined effects of different influencing factors
- Enrichment of pollutants on the product
- Nature of fastening part: fastener must be made of a more noble material or the same material than the fastened part

### 4.9.2 Galvanic (contact) corrosion

Galvanic corrosion refers to corrosion damage where two dissimilar metals have an electrically conducting connection and are in contact with a common corrosive electrolyte.

Generally, the less noble metal will be dissolved (anodic metal dissolution), whereas the more noble part is not attacked by corrosion (serves only as the cathode for oxygen reduction). Where galvanic corrosion takes place, the rate of corrosion of the less noble metal is higher than it would be in a free corroding environment without contact to another metal.

Galvanic corrosion can be avoided by the right choice of material combinations. To minimize galvanic corrosion, the difference in free corrosion potential between the materials should be as low as possible, and/or the surface ratio of less noble metal to nobler metal should be very high. The free corrosion potential depends on the standard potential, a given thermodynamic value for each metal and the corrosive environment.

As a general rule of thumb, a fastener should always be made of the same or a more noble metal than the part to be fastened in order to prevent failure of the fastener. The fastener typically has the smaller surface area.

The following table shows the impact of galvanic corrosion under atmospheric **outdoor conditions** for various material combinations.

In **dry indoor applications** contact corrosion can be neglected and usually there are no susceptible material combinations.

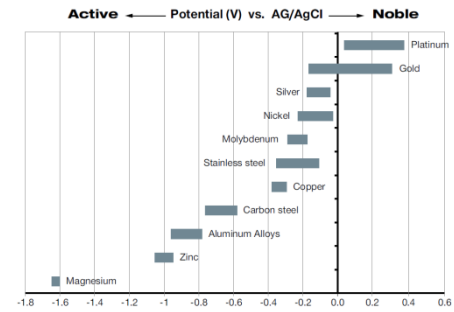

Corrosion potential of various metals in sea water

	Fastener (small area)	
	Carbon steel (Duplex-coated) S-BT-MF HL S-BT-MF MT HL S-BT-GF HL S-BT-EF (HL) HL	Stainless steel S-BT-MR HL S-BT-GR HL S-BT-ER (HL) HL
<b>Fastened part (large area)</b>		
Electrogalvanized	□	□
Hot-dip galvanized	□	□
Aluminum	■	□
Structural or cast steel	■	□
Stainless steel (CrNi or CrNiMo)	■	□
Tin	■	□
Copper	■	□
Brass	■	□

- No impact on lifetime
- moderate impact on lifetime, technically accepted in many cases
- strong impact on lifetime

Impact on lifetime of the S-BT HL fastener by galvanic (contact) corrosion



This is a typical case of contact corrosion. Zinc-plated carbon steel (washer) and stainless steel (screw and part) were used together. The surface area of the more noble metal – the stainless steel – is larger, causing strong corrosion of the washer.

### 4.9.3 Carbon steel S-BT HL studs

#### General comments

The coating of the carbon steel S-BT HL fasteners consists of an electroplated Zn-alloy for cathodic protection and a top coat for chemical resistance (Duplex-coating). The use of this coating is limited to the corrosion category C1, C2 and C3 according the standard EN ISO 9223. For higher corrosion categories stainless steel fasteners should be used.

Thanks to extensive research in close cooperation with renowned universities and laboratories, designers can trust and rely on the multilayer coating for S-BT HL.

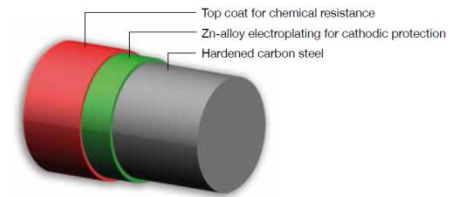

Duplex-coating on carbon steel S-BT HL fasteners

Indoor applications	
	<b>Dry indoor environments</b> (heated or air-conditioned areas) without condensation, e.g. office buildings, schools
	<b>Indoor environments with temporary condensation</b> (unheated areas without pollutants), e.g. storage sheds
Outdoor applications	
	<b>Outdoor, rural or urban environment with low pollution</b> Large distance (> 10 km) from the sea
	<b>Outdoor, rural or urban environment with moderate concentration of pollutants</b> and/or salt from sea water Distance from the sea 1-10 km

Environmental conditions for usage of coated carbon steel S-BT studs

#### Note:

ETA-23/0001 allows the use of carbon steel threaded studs with duplex coating only in dry indoor environment (C1 acc. to EN ISO 9223).

#### Test concept

Laboratory and field tests are performed to assess the expected lifetime and technical safety aspects for fasteners. The duplex coating on the S-BT HL was tested in neutral salt spray according to DIN EN ISO 9227, which is the most commonly used accelerated corrosion test for corrosion assessment. This test is suitable for quality assessment but does not reflect real environmental conditions. In contrast, cyclic corrosion tests like ISO 16701 reproduce and accelerate corrosion mechanisms that occur under real environmental conditions. This test is well adapted for lifetime assessment under moderate atmospheric conditions. The fasteners are subjected through cycled climate conditions such as temperature variations, humidity and dry periods as well as corrosion attack through salt. Results of laboratory tests are verified by mid- and long term field tests in natural climatic conditions.

During the setting process, the fastener is subjected to strong impacts. To ensure that the corrosion resistance of the S-BT HL remains intact, Hilti performs all corrosion tests on S-BT HL in mounted condition and the fasteners are installed in steel plates with the recommended tools.



Prepared S-BT HL fastenings



Removed S-BT HL fasteners after 12 weeks EN ISO 16701 cyclic corrosion test. No visible corrosion.

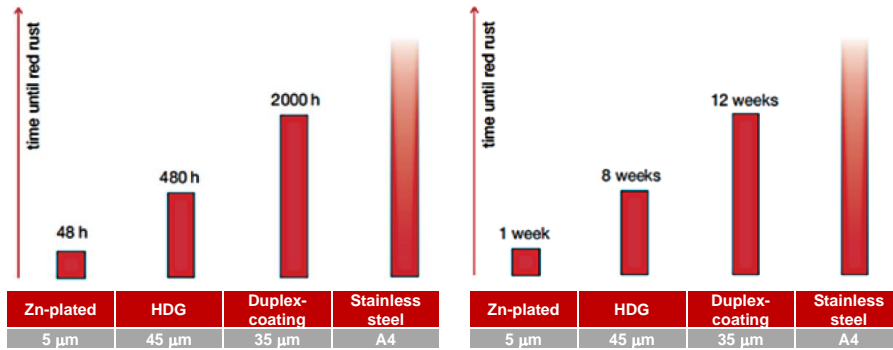

### Neutral salt spray test

S-BT HL studs with duplex-coating are subjected to a neutral salt spray test according to DIN EN ISO 9227. Under this test, the corrosion resistance of S-BT HL studs with duplex-coating is significantly higher as compared to hot dip galvanized (HDG) systems with at least 45 µm coating thickness. Grade A4 stainless steel S-BT HL studs remain stable under this test and withstand corrosion due to passive surface.

### Cyclic corrosion test

The cyclic corrosion test gives a more realistic assessment of corrosion resistance under natural environments. Under this test, the corrosion resistance of S-BT HL studs with duplex-coating is comparable and even higher than HDG systems. Grade A4 stainless steel S-BT HL studs also remain stable under this cyclic corrosion test.

### Test results

On the S-BT HL studs with aluminum sealing washer no corrosion was found after 12 weeks in the cyclic corrosion test. All aluminum sealing washers have adequately sealed the drilled holes over the test period of time. There was no visible corrosion in the bore holes.

### Conclusions

- In the ISO 16701 test, the material combination of aluminum sealing washer and the duplex-coating of the carbon steel S-BT HL studs has been found to be optimal.
- After 12 weeks in the cyclic climate chamber the coating system of the carbon steel S-BT HL studs showed no tendencies to contact corrosion. The combination is suitable for use in C1, C2 and C3 environment acc. DIN EN ISO 9223:2012
- No corrosion was found in the drilled holes. This is strong evidence that the sealing washer provides an effective seal.





#### 4.9.4 Stainless steel S-BT HL studs

##### General comments

The S-BT HL stainless studs are made from the duplex stainless steel type 1.4462. This grade of stainless steel is classified as corrosion resistance class IV according to DIN EN 1993-1-4:2015, which makes the material suitable for aggressive environments like in coastal and offshore applications. The microstructures of duplex stainless steels consist of a mixture of austenite and ferrite phases. Compared to the austenitic stainless steel grades, duplex stainless steels are magnetic. The surface of the S-BT HL stainless steel fasteners is zinc plated (anti-friction coating) in order to reduce the thread forming torque when the stud is screwed in into the base material. When the zinc is exposed to hydrogen and oxygen in the environment, it combines to

create zinc hydroxide, which is the white residue seen on the stud. The deposition of zinc hydroxide slowly consumes the zinc coating, however in this case as the base material is stainless steel, this does not lead to any risk of corrosion. The zinc plating is to reduce the thread forming torque when setting the stud so once set the coating no longer has a functional requirement.

The Hilti X-BT system was developed by Hilti Corporation especially for applications on steel structures that form part of oil and gas production facilities, in shipbuilding and in general steel construction. Therefore, comprehensive corrosion tests (electrochemical tests, field test) have been performed on the X-BT stud. The stainless-steel S-BT HL studs are intended to be used for the same applications and the studs are made of the same material as the shank of the X-BT fastener, duplex steel type 1.4462.

Outdoor applications	
	<b>Outdoor, rural or urban environment with low pollution</b> Large distance (> 10 km) from the sea
	<b>Outdoor, rural or urban environment with moderate concentration of pollutants</b> and/or salt from sea water Distance from the sea 1-10 km
	<b>Coastal areas</b> Distance from the sea < 1 km
	<b>Outdoor, areas with heavy industrial pollution</b> Atmospheric SO <sub>2</sub> concentration > 10 µg/m <sup>3</sup> as yearly average (e.g. close to polluting plants)
	<b>Close proximity to roadways</b> treated with de-icing salts, Distance from roadways < 10 m

Environmental conditions for usage of stainless steel S-BT HL studs.

### Test concept

The corrosion behavior of the X-BT fastener was assessed by MPA Stuttgart in 2009. Based on these investigations, MPA Stuttgart assessed the corrosion behavior of the stainless-steel S-BT HL fasteners.

The MPA report evaluates and assesses the S-BT HL stainless studs in terms of the following corrosion topics:

- Evaluation and assessment of atmospheric corrosion
  - Pitting or crevice corrosion
  - Stress corrosion cracking
  - Bimetallic corrosion
- Corrosion resistance of stainless steels on the basis of their composition
- Long-term exposure tests in maritime atmospheres
- Electrochemical tests

### Test results

- On the basis of the investigations mentioned above, MPA Stuttgart assumed that the stainless S-BT HL studs have very good resistance to corrosion, even in atmospheres containing chlorides and are comparable to that of the X-BT.
- Tests at MPA Stuttgart confirmed high resistance to pitting or crevice corrosion.
- Tests carried out at the University of Leoben showed that the material also has good resistance to stress corrosion cracking even in highly aggressive media.

## Conclusions

Hilti S-BT HL stainless fasteners made from stainless steel offer excellent corrosion resistance in atmospheres containing chloride ions, i.e. coastal areas and areas near roads treated with de-icing salts.

Based on the examinations from MPA Stuttgart, the estimated lifetime in typical atmospheres, from a corrosion-specific point of view, is at least 40 years.

### 4.9.5 Conductivity disc of S-BT-ER HL / -EF HL electrical connectors

The conductivity disc of the S-BT-ER HC / -EF HC is made from copper alloy CuSn8 with a tin-coating on the surface and a sealing ring on the bottom side. The copper alloy is classified as largely insensitive to stress corrosion cracking and pitting corrosion. The conductivity disc is designed for use in corrosion categories C1 - C5 according to EN ISO 9223. It is therefore suitable for use in aggressive environments like coastal and offshore applications.

### 4.9.6 Standoff Adapters

#### Standoff adapters made of duplex-coated carbon steel

The coating of the carbon steel standoff adapters consists of an electroplated Zn-alloy for cathodic protection and a top coat for chemical resistance (Duplex-coating). The use of this coating is limited to the corrosion category C1, C2 and C3 according to the standard EN ISO 9223. For higher corrosion categories stainless steel standoff adapters should be used.

#### Standoff adapters made of stainless steel

The stainless steel standoff adapters are made from the stainless steel type 1.4401 (AISI 316). This grade of stainless steel is classified as corrosion resistance class III according to DIN EN 1993-1-4:2015, which makes the material suitable for outdoor applications and atmospheres containing chloride ions, i.e. coastal areas and areas near roads treated with de-icing salts.

#### Standoff adapter M10-HC120 and W10-HC4/0 for high current

The standoff adapters M10-HC120 and W10-HC4/0 are made from copper alloy CuSn8. The copper alloy is classified as largely insensitive to stress corrosion cracking and pitting corrosion. The adapters are designed for use in corrosion categories C1 - C5 according to EN ISO 9223. They are therefore suitable for use in aggressive environments like coastal and offshore applications.

### 4.9.7 Hilti Coupler RC-MF and RC-MR

#### Hilti Coupler RC-MF made of duplex-coated carbon steel

The coating of the carbon steel Hilti Coupler RC-MF consists of an electroplated Zn-alloy for cathodic protection and a top coat for chemical resistance (Duplex-coating). The use of this coating is limited to the corrosion category C1, C2 and C3 according to the standard EN ISO 9223. For higher corrosion categories stainless steel standoff adapters should be used.

#### Hilti Coupler RC-MR made of stainless steel

The stainless steel Hilti Coupler RC-MR are made from the stainless steel type 1.4401 (AISI 316) or 1.4404 (AISI 316L). These grades of stainless steel are classified as corrosion resistance class III according to



DIN EN 1993-1-4:2015, which makes the materials suitable for outdoor applications and atmospheres containing chloride ions, i.e. coastal areas and areas near roads treated with de-icing salts.

#### 4.9.8 X-FCM grating fasteners

##### **X-FCM grating fasteners made of zinc coated carbon steel**

The coating of the carbon steel grating fasteners consists of an electroplated zinc coating. The use of this coating is limited to the corrosion category C1 according to the standard EN ISO 9223. For higher corrosion categories duplex coated grating fasteners or stainless steel grating fasteners should be used.

##### **X-FCM-F, X-FCM-F L and X-FCM-F NG grating fasteners made of duplex-coated carbon steel**

The coating of the X-FCM-F, X-FCM-F L and X-FCM-F NG carbon steel grating fasteners consists of an electroplated Zn-alloy for cathodic protection and a top coat for chemical resistance (duplex-coating). The use of this coating is limited to the corrosion category C1, C2 and C3 according to the standard EN ISO 9223 (indoors, mildly corrosive environment). The carbon steel grating fasteners are to be used for fastening gratings made of coated or galvanized carbon steel or gratings made of reinforced fibreglass.

**Note:** The fasteners are not for use in marine atmosphere or in heavily polluted environment.

##### **X-FCM-R, X-FCM-R L, X-FCM-R NG and X-FCM-R HL grating fasteners made of stainless steel**

The X-FCM-R, X-FCM-R L, X-FCM-R NG and X-FCM-R HL stainless steel grating fasteners are made from the stainless-steel type 1.4404, which is equivalent to AISI 316L (A4) steel grade. This grade of stainless steel is classified in the corrosion resistance class III according to DIN EN 1993-1-4:2015, which makes the material suitable for aggressive environments like in coastal and offshore applications.

The stainless-steel grating fasteners are to be used for fastening gratings made of stainless steel or gratings made of reinforced fibreglass.

**Note:** The fasteners are not for use in automobile tunnels, swimming pools or similar environments.

**4.10 Fire resistance**

Test Report No. 20161614 and No. 20170384  
 MPA Dresden GmbH – IMO Recognized Test Laboratory (2017) [1] and [2]

**General comments**

When using Hilti S-BT fasteners in combination with fire rated boundaries in Shipbuilding facilities, the effect of the fastener on the mechanical resistance of the steel base material (bulkheads, decks) has to be considered. Furthermore, the behavior of the Hilti S-BT screw-in threaded studs under fire conditions, whilst supporting a load, has to be checked.

**Test concept**

The tests were performed according the requirements of IMO Resolution MSC.307(88), Fire Test Procedure Code, 2010, part 3 [3]. In order to test the S-BT fastener in the most onerous manner, a “A-0” class bulkhead (uninsulated) was tested at MPA Dresden.

For the test, two bulkhead sizes were used.

The big A-0 bulkhead is a 2980 mm square. The plate of the bulkhead consists of a 5 mm thick steel plate with 65 x 65 x 6 mm L-stiffener along the vertical edges. The constructional details of the test specimen used are given in the corresponding test report [1] and Figure 1.

The small A-0 bulkhead is a 980 mm square and is fabricated in two halves. Viewed from the unexposed face the left-hand side of the bulkhead consists of a 3 mm steel plate with a Bulb flat 80 x 5.0 stiffener along the vertical edge. The right-hand side of the bulkhead consists of a 6 mm steel plate with a Bulb flat 80 x 5.0 stiffener along the vertical edge. There is also a central stiffener (Bulb flat 80 x 5.0). The constructional details of the test specimen used are given in the corresponding test report [2] and Figure 2.

The bulkheads were installed such that the stiffeners and the S-BT studs were on the unexposed face of the specimen.

A total of eight S-BT threaded studs (big bulkhead) and ten S-BT threaded studs (small bulkhead) were fitted to the bulkhead and were subjected to either a tension or shear load.

The loading details of each S-BT stud and an overview of the selected test program are given in Table 1 and Table 2.



**Figure 1:** Test facility for fire test (big bulkhead)



**Figure 2:** Test facility for fire test (small bulkhead)

Stud #	Force [kN]	Type of force	S-BT Type	Base material thickness [mm]
1	0.53	Tension	S-BT-MR M8/15 SN6	6.0 (L-stiffener)
2	0.51	Tension	S-BT-MR M8/15 SN6	5.0 (Plate)
3	0.52	Tension	S-BT-MF M8/15 AN6	5.0 (Plate)
4	0.52	Tension	S-BT-MF M8/15 AN6	6.0 (L-stiffener)
5	0.50	Shear	S-BT-MR M8/15 SN6	6.0 (L-stiffener)
6	0.50	Shear	S-BT-MR M8/15 SN6	5.0 (Plate)
7	0.50	Shear	S-BT-MF M8/15 AN6	5.0 (Plate)
8	0.50	Shear	S-BT-MF M8/15 AN6	6.0 (L-stiffener)

**Table 1:** Test program of the big bulkhead 2980 mm x 2980 mm

Stud #	Force [kN]	Type of force	S-BT Type	Base material thickness [mm]
1	0.53	Tension	S-BT-MR M8/15 SN6	Bulb Flat 80 x 5.0
2	0.26	Tension	S-BT-MR M8/15 SN6	3.0 (Plate) (drill through hole)
3	0.52	Tension	S-BT-MF M8/15 AN6	6.0 (Plate)
4	0.52	Tension	S-BT-MF M8/15 AN6	Bulb Flat 80 x 5.0
5	0.50	Shear	S-BT-MR M8/15 SN6	Bulb Flat 80 x 5.0
6	0.25	Shear	S-BT-MR M8/15 SN6	3.0 (Plate) (drill through hole)
7	0.25	Shear	S-BT-MF M8/15 AN6	3.0 (Plate) (drill through hole)
8	0.50	Shear	S-BT-MR M8/15 SN6	6.0 (Plate)
9	0.50	Shear	S-BT-MF M8/15 AN6	6.0 (Plate)
10	0.50	Shear	S-BT-MF M8/15 AN6	Bulb Flat 80 x 5.0

**Table 2:** Test program of the small bulkhead 980 mm x 980 mm

According to [3], for all “A” class divisions the following requirements shall be satisfied for the minimum test duration of 60 min.

- Flaming: there shall be no flaming and smoke on the unexposed face
- Gap gauges: it shall not be possible to enter the gap gauge into any opening in the specimen
- Stability of the test specimen

For “A-0” class bulkheads the average unexposed-face temperature rise is not applicable.

In addition to the requirements above a further requirement is defined:

- The installed S-BT studs shall maintain their loads (tension or shear) for a period of 60 minutes

During the test the average furnace temperature, the unexposed surface temperature adjacent to the installed S-BT studs and the deflection of the bulkhead were measured and recorded.

The test setup, measurements and the results are described in detail in [1] and [2].

### Test results

For the tests, S-BT-MR M8/15 (stainless steel) and S-BT-MF M8/15 (carbon steel) were used. The threaded tip of the S-BT studs and the sealing washer (area A in Figure 3) is identical for all dimensions. Only the threads (e.g. M8, M10, W10) for attachment of supported materials (area B in Figure 3) are different. For this reason, S-BT studs with thread M8 were chosen for the tests in order to adopt the test results to the bigger threads M10 / W10.

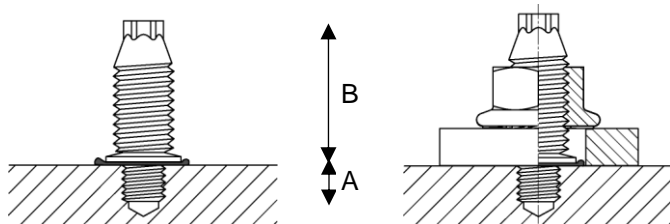

**Figure 3:** Geometry of S-BT studs

Stability of the test specimen was given during the 60 test minutes. All installed S-BT studs were able to maintain their loads (ref. to Table 1 and Table 2) for a period of 60 minutes whilst the bulkhead was subjected to a test, which utilized the conditions given in IMO Resolution MSC.307(88), FTP Code, 2010 for “A-0” bulkheads. There was no occurrence of any flaming or smoke on the unexposed surface of the specimen during the test. In the test specimen there were no openings or cracks visible during the whole test period.

### Conclusions

Both bulkheads passed the performance criteria of IMO Resolution MSC.307(88), FTP Code, 2010 for “A-0” bulkheads. The installed S-BT studs didn’t affect the fire resistance of steel bulkheads and the studs were able to maintain their loads for a period of 60 minutes.

Based on the test results the use of S-BT studs for applications in fire rated boundaries on ships can be recommended.

### Recommended loads for applications in fire rated boundaries

	<b>S-BT-MR HL / S-BT-MF HL</b>	
Base material	<b>Steel</b> with yield strength $R_{eH}$ $235 \text{ MPa} \leq R_{eH} \leq 355 \text{ MPa}$ (ordinary strength e.g. S235, Grade A up to higher strength e.g. S355, Grade AH36)	
Drill hole type and base material thickness	Pilot hole, $t_{II} \geq 6 \text{ mm}$ [0.24"] Drill through hole, $5 \text{ mm}$ [0.20"] $\leq t_{II} < 6 \text{ mm}$ [0.24"]	Drill through hole $3 \text{ mm} \leq t_{II} < 5 \text{ mm}$
Tension, R60, $N_{rec,fi}$ [kN/lb]	0.50 / 112	0.25 / 56
Shear, R60 $V_{rec,fi}$ [kN/lb]	0.50 / 112	0.25 / 56

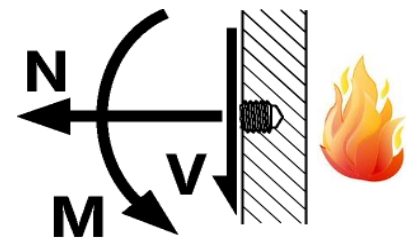

### Conditions for recommended loads:

- Use S-BT-MR HL and S-BT-MF HL (multipurpose fastening) only with the attached Hilti serrated flange nuts M8, M10, W10 (© or © refer to section 3.1.1)
- S-BT HL studs installed on the unexposed face of the bulkhead
- Global factor of safety  $\Omega_{fi}$  for static pull-out and static shear = 1.0.
- Minimum edge distance = 6 mm [0.24"], spacing  $\geq 18 \text{ mm}$  [0.709"]
- Redundancy (multiple fastening) must be provided.
- If eccentric loading exists (e.g. use of an angle clip), moments caused by off-center loading must be considered.

### Literature:

- [1] MPA Dresden: Test Report No. 20170384, MPA Dresden GmbH – IMO Recognized Test Laboratory, Dresden (D), July 20<sup>th</sup>, 2017
- [2] MPA Dresden: Test Report No. 20161614, MPA Dresden GmbH – IMO Recognized Test Laboratory, Dresden (D), July 21<sup>st</sup>, 2017
- [3] IMO Resolution MSC.307(88), Fire Test Procedure Code, 2010

**4.11 Volume swelling of SN 12 sealing washer  
(stainless steel S-BT HL studs)**

(Refer to section 3.1.1 material No. ③)

Chemicals	Volume swell				
	< 20%	20-40%	> 40-60%	> 60-80%	> 80-100%
1. Water at 80°C	■				
2. Sea water	■				
3. Zinc chloride 10%	■				
4. Sodium chloride 15%	■				
5. Hydrochloric acid 10%	■				
6. Acetic acid	■				
7. Acrylonitrile				■	
8. Aniline				■	
9. n-Butyl acetate					■
10. Diethylether		■			
11. Ethanol	■				
12. Glycerol	■				
13. n-Hexane	■				
14. Methanol	■				
15. Methyleneethylketone				■	
16. Nitrobenzene				■	
17. 1-Propanol	■				
18. Oil (ASTM-1) at 80°C	■				
19. Oil (ASTM-2) at 80°C		■			
20. Oil (ASTM-3) at 80°C		■			
21. Reference fuel B (isooctane/toluene, 70/30)				■	
22. Reference fuel C (isooctane/toluene, 50/50)					■
23. Hydraulic brake fluid	■				
24. Hydraulic brake fluid at 100°C		■			
25. Antifreeze (ethylene glycol/water 50/50) at 125°C		■			

Material: 3.1107 Chloroprene Rubber: ozone and UV resistance  
Temperature range: -40 °C to +60 °C

Volume swelling is a reaction of the material of the washer when it's in contact with the different substances. It's used as a parameter to describe the chemical reaction.

The swelling factor gives an indication of the behavior of the material, but swelling does not lead directly to loss of the sealing property. With an installed stainless steel S-BT HL stud, the washer is compressed against the base steel.

Without any specific requirement a general guideline is that the washer material is resistant to all substances where the volume swelling value is ≤ 40%.

The table above is valid only for stainless steel S-BT HL studs.

## 5 SPECIAL APPLICATIONS

### 5.1 Fastenings to steel with a passive fire protection (PFP) coating

#### 5.1.1 Multipurpose fastening to steel with a passive fire protection (PFP) coating

##### Installation instructions

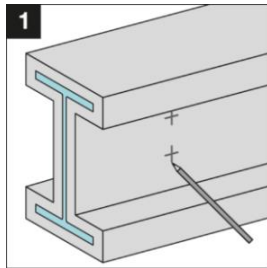

1 Mark location of each fastening.

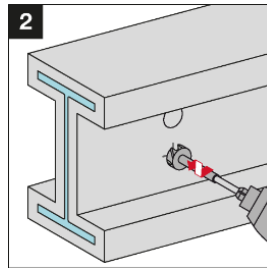

2 Remove PFP and pre-drill with **TS-BT 31-95 PFP** stepped drill bit ...

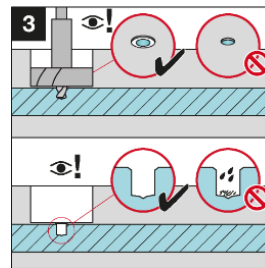

3 ... until shoulder grinds a shiny ring. The area must be clean and free from liquids and debris.

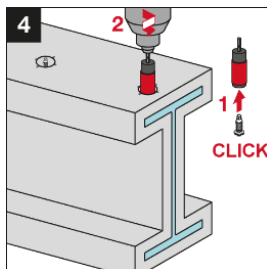

4 Set S-BT HL studs into drilled hole.

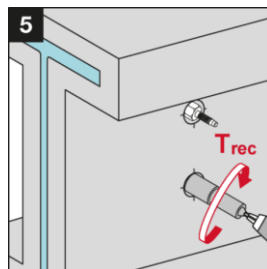

5 Tighten the standoff adapter with the recommended installation torque  $T_{rec}$  of **8 Nm**.

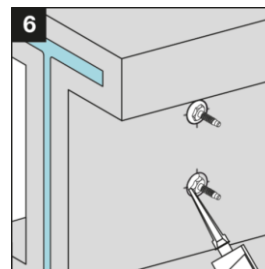

6 Close the opening within 4 hours of the opening is being made in accordance to the patching instructions by the PFP-manufacturer.

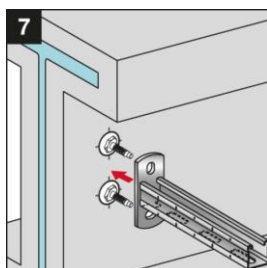

7 Position accessory on standoff adapter and hold in place. Use of MQZ bore plate as needed for strut applications.

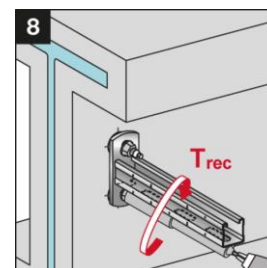

8 Fasten the accessory on the standoff adapter with the recommended installation torque  $T_{rec}$  of **20 Nm**.

##### Important notes:

These are abbreviated instructions which may vary by application. ALWAYS review / follow the instructions for use (IFU) accompanying the product

### 5.1.2 Grating fastening to steel with a passive fire protection (PFP) coating

#### Installation instructions

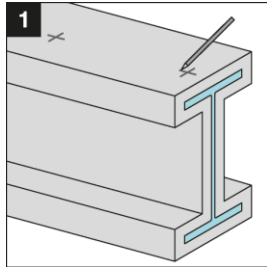

1 Mark location of each fastening.

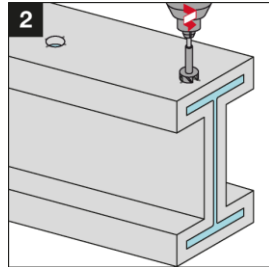

2 Remove PFP and pre-drill with **TS-BT 31-95 PFP** stepped drill bit ...

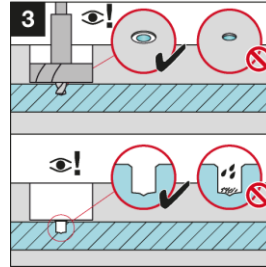

3 ... until shoulder grinds a shiny ring. The area must be clean and free from liquids and debris.

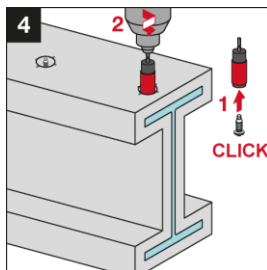
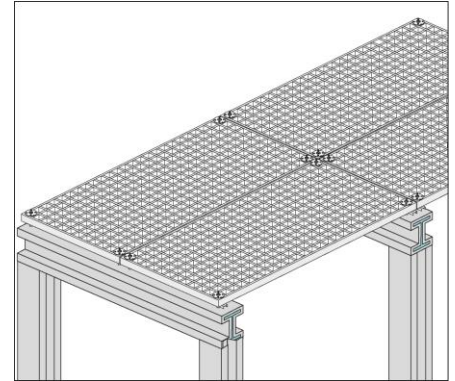

4 Set S-BT HL studs into drilled hole.

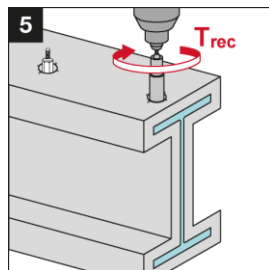

5 Tighten the standoff adapter with the recommended installation torque  $T_{rec}$  of **8 Nm**.

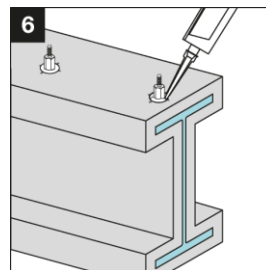

6 Close the opening within 4 hours of the opening is being made in accordance to the patching instructions by the PFP-manufacturer.

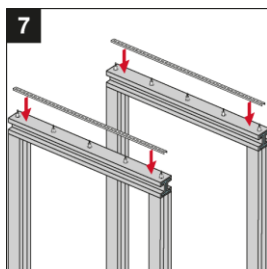

7 Position Oglænd channel CH50-1 on standoff adapter. <sup>1)</sup>

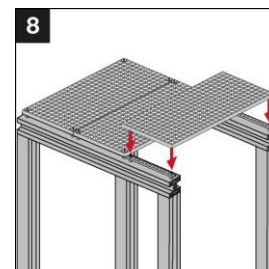

8 Position grating on top of the Oglænd channel S-M CH50-1 and standoff adapter and hold in place.

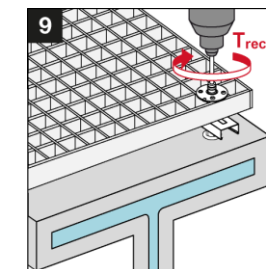

9 Tighten X-FCM discs with 5 mm Allen-type bit with the suited installation torque.

<sup>1)</sup> if a Oglænd channel CH50-1 is used, a stainless steel washer is required between the standoff adapter and the channel to prevent deformation of the channel when the X-FCM disc is tightened.

#### Important notes:

These are abbreviated instructions which may vary by application. ALWAYS review / follow the instructions for use (IFU) accompanying the product

**5.1.3 Installation details: Fastening S-BT HL threaded studs with standoff adapter to steel with a passive fire protection (PFP) coating**

- ① **Mark location for each fastening**
- ② **Remove PFP and predrill with TS-BT 31-95 PFP stepped drill bit**  
Usage of SBT 6-22 until the bit shoulder exposes steel and the shoulder grinds a shiny ring to ensure a proper drilling depth. Result is a circle of exposed steel with  $\varnothing$  7.5 mm as well as a maintaining surrounding coating thickness  $\leq$  300  $\mu$ m.
- ③ **Screw in the S-BT HL fastener and check standoff**  
Use SBT 6-22 and stud holder S-SH BT. Verify stud standoff with the inspection card S-IC BT.
- **Screw standoff adapter on the S-BT HL fastener**  
Usage of nut setter S-NS 95/3 1/4" in combination with torque tool X-BT 1/4" – 8 Nm or Hilti screw drivers with correct torque setting  $T_{rec}$  8 Nm.
- ⑤ **Repair removed PFP-coating outside of standoff adapter**  
Prevent delamination of PFP-coating as well exposure of underlying steel beam by patching area outside of standoff adapter in accordance to the patching instructions by the PFP-manufacturer.
- ⑥ **Position channel, grating or accessory on standoff adapter**  
Tighten nuts or grating fastener by hand.
- ⑦ **Tighten the nuts or grating fastener with recommended torque**  
Usage of nut setter S-NS 95/3 1/4" in combination with Hilti torque tool or Hilti drill drivers with correct torque setting.



Locally exposed steel with shiny ring after PFP-removal operation

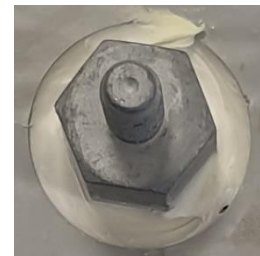

Repaired opening of PFP-coating

**Important notes:**

The setting of the torque via the Hilti screwdriver with torque release coupling (TRC) can change as the clutch wears over time. The specified torque setting is only a rough guide value and applies to a new Hilti screwdriver. To ensure recommended torque is applied, Hilti recommends the use of a calibrated torque wrench or the Hilti torque tool.

The specified torque setting for the Hilti screw drivers with electronic slip clutch (ESC) is only a rough guide value as the ESC has 2 stop detections; Soft Joint (SJ) detection and Hard Joint (HJ) detection. The hard joint detection is activated due to drop in speed (fast stop) and can lead to a torque spike. The installation torque may vary depending on the user and the application. To ensure recommended torque is applied, Hilti recommends the use of a calibrated torque wrench or the Hilti torque tool.



**5.2 Electrical connectors with Hilti standoff adapter to steel with a passive fire protection (PFP) coating**

**5.2.1 Electrical connectors S-BT-ER HL with Hilti standoff adapter made of stainless steel to steel with a passive fire protection (PFP) coating (permanent and short circuit current)**

**Installation instructions**

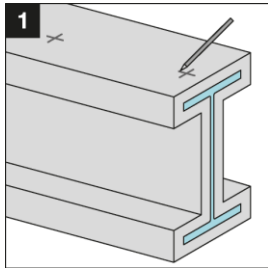

1 Mark location of each fastening.

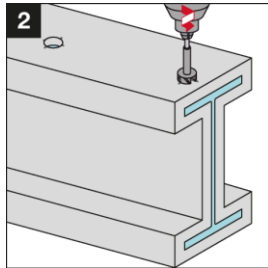

2 Remove PFP and pre-drill with **TS-BT 31-95 PFP** stepped drill bit ...

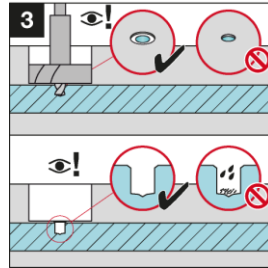

3 ... until shoulder grinds a shiny ring. The area must be clean and free from liquids and debris.

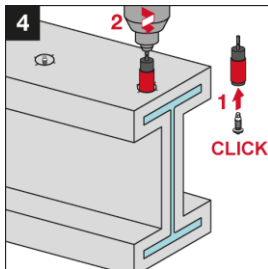

4 Set S-BT HL electrical connector into drilled hole.

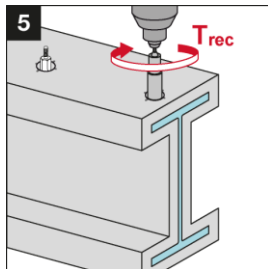

5 Tighten the standoff adapter with the recommended installation torque  $T_{rec}$  of **8 Nm**.

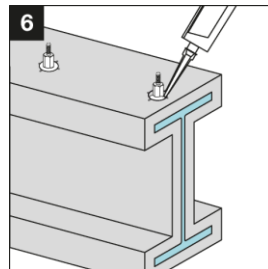

6 Close the opening within 4 hours of the opening is being made in accordance to the patching instructions by the PFP-manufacturer.

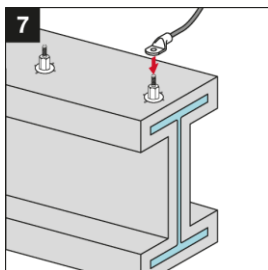

7 Position cable lug on standoff adapter and hold in place.

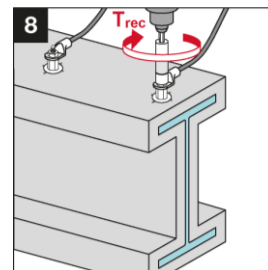

8 Add the spring washer and tighten the nut with the recommended installation torque  $T_{rec}$  of **16 Nm**.

**Important notes:**

These are abbreviated instructions which may vary by application. ALWAYS review / follow the instructions for use (IFU) accompanying the product

**5.2.2 Electrical connectors S-BT-ER HL with Hilti standoff adapter made of stainless steel to steel with a passive fire protection (PFP) coating (lightning current)**

**Installation instructions**

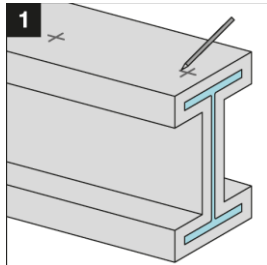

1 Mark location of each fastening.

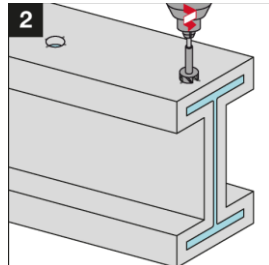

2 Remove PFP and pre-drill with **TS-BT 31-95 PFP** stepped drill bit ...

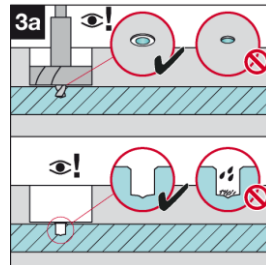

3a ... until shoulder grinds a shiny ring.

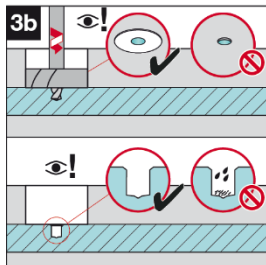

3b Prepare contact surface between base material steel and standoff adapter with **TS-BT 5.3 HC 95** decoater.

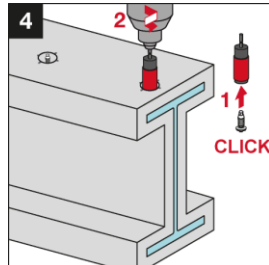

4 Set S-BT HL electrical connector into drilled hole.

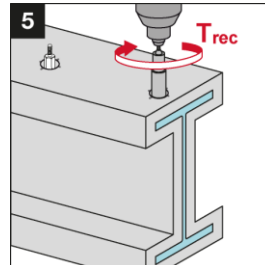

5 Tighten the standoff adapter with the recommended installation torque  $T_{rec}$  of **8 Nm**.

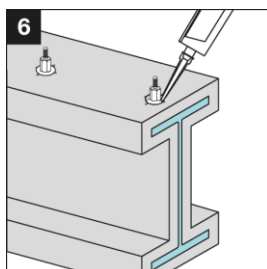

6 Close the opening within 4 hours of the opening is being made in accordance to the patching instructions by the PFP-manufacturer.

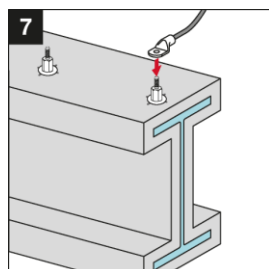

7 Position cable lug on standoff adapter and hold in place.

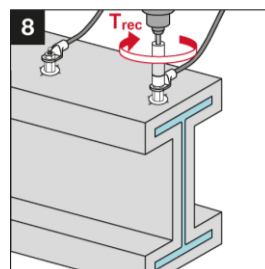

8 Add the spring washer and tighten the nut with the recommended installation torque  $T_{rec}$  of **16 Nm**.

**Important notes:**

These are abbreviated instructions which may vary by application. ALWAYS review / follow the instructions for use (IFU) accompanying the product

**5.2.3 Electrical connectors S-BT-ER HL with Hilti High Current standoff adapter M10-HC120 / W10-HC4/0 to steel with a passive fire protection (PFP) coating**

**Installation instructions**

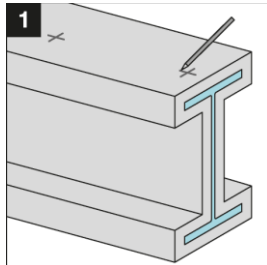

1 Mark location of each fastening.

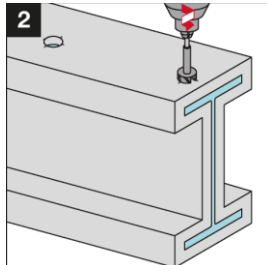

2 Remove PFP and pre-drill with **TS-BT 31-95 PFP** stepped drill bit ...

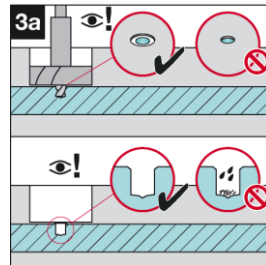

3a ... until shoulder grinds a shiny ring.

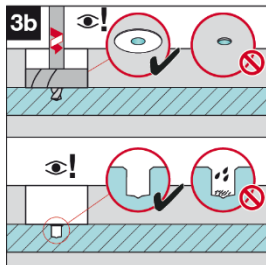

3b Prepare contact surface between base material steel and standoff adapter with **TS-BT 5.3 HC 95** decoater.

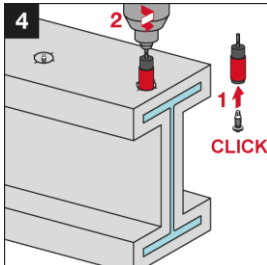

4 Set S-BT HL electrical connector into drilled hole.

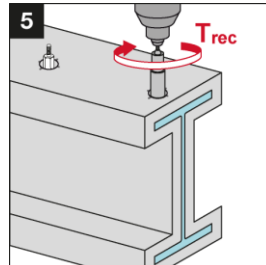

5 Tighten the HC standoff adapter with the recommended installation torque  $T_{rec}$  of **8 Nm**.

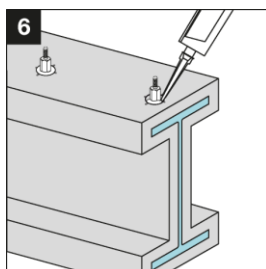

6 Close the opening within 4 hours of the opening is being made in accordance to the patching instructions by the PFP-manufacturer.

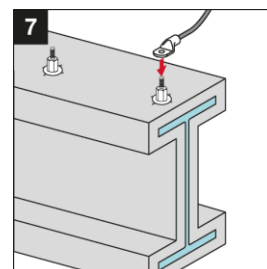

7 Position cable lug on standoff adapter and hold in place.

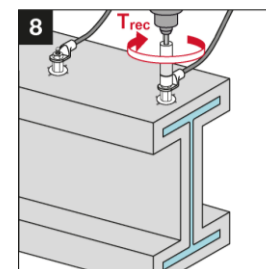

8 Add the spring washer and tighten the nut with the recommended installation torque  $T_{rec}$  of **16 Nm**.

**Important notes:**

These are abbreviated instructions which may vary by application. ALWAYS review / follow the instructions for use (IFU) accompanying the product

**5.3 Applications with standoff adapter e.g. fastening to insulated steel members or insulated bulkheads**

**Installation instructions**

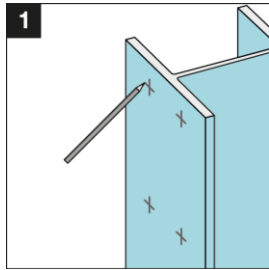

1 Mark location of each fastening.

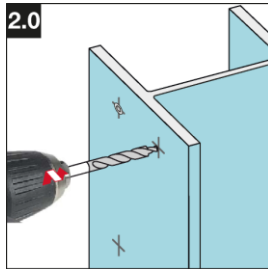

2.0 Pre-drill with **TS-BT 5.3-65 S** stepped drill bit.

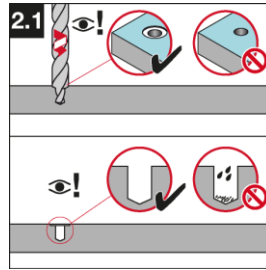

2.1 Pre-drill until shoulder grinds a shiny ring. The drilled hole and the area around drilled hole must be clean and free from liquids and debris.

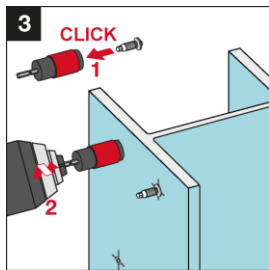

3 Screw-in S-BT HL studs into drilled hole.

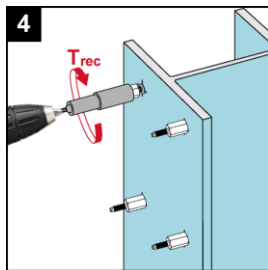

4 Tighten the standoff adapter with the recommended installation torque  $T_{rec}$  of 8 Nm.

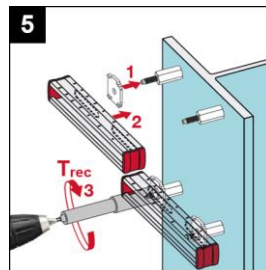

5 Position channel on standoff adapter and hold in place. Tighten the nuts with a tightening torque  $T_{rec}$  of **20 Nm**.

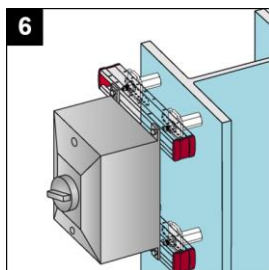

6 Fasten the accessory on the channel with the suited installation torque.

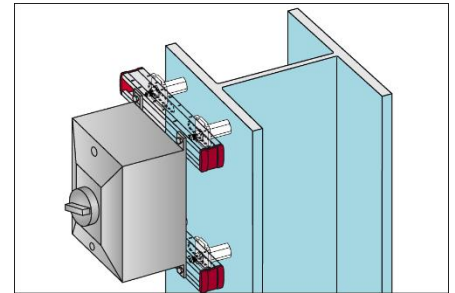
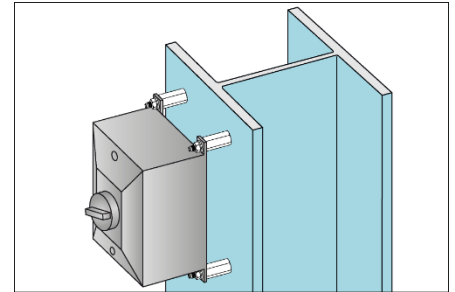

**Important notes:**

These are abbreviated instructions which may vary by application. ALWAYS review / follow the instructions for use (IFU) accompanying the product. In case of a **drill through hole**, rework of the coating on the back side of the plate / profile may be needed.

**5.4 Installation of S-BT HL with pneumatic tools in e.g. explosive environments**

**General comments**

When installing S-BT HL threaded studs in e.g. explosive environments (ATMosphères Explosives = ATEX), the use of standard power tools and the cordless Hilti drill driver SBT 6-22 as defined in sections 1.2.2 and 1.2.4 is restricted.

In order to enable the drilling of the borehole and installation of S-BT HL threaded studs in explosive environments, Hilti has successfully tested and qualified pneumatic tools for drilling and for setting respectively.

To ensure correct fastening quality and operator safety, we recommend the use of the following tools for drilling the borehole and setting the S-BT HL in conjunction with the Hilti S-DG BT depth gauge. These tools have been extensively tested for S-BT HL applications and have been qualified upon successful completion of the tests.

**Pneumatic drilling tool**

Brand	Product Code	Application
IR Ingersoll Rand	7802RAKCEX	Drilling
Midland Air Tools LTD	CP1114R26 ATEX	Drilling

**Pneumatic setting tool**

Brand	Product Code	Application
Speedaire	0.5Hp 21AA74	Setting
Snap-on	PDR5000A	Setting

**S-DG BT depth gauge with a S-CC calibration card**

Designation	Item Description	Application
S-DG BT M8/7 Short 6	Depth gauge for S-BT M8/7 HL	Setting
S-DG BT M8/15 Long 6	Depth gauge for S-BT M8/15 HL	Setting
S-DG BT M10-W10/15 Long 6	Depth gauge for S-BT M10/W10 HL	Setting
S-CC BT 6	Calibration card for calibration of the depth gauge (short/long studs)	Calibration / Verification
S-CG BT HC	Check gauge for verification of the standoff for S-BT M10/W10 HC	Verification

In order to ensure an accurate screw-in depth and a properly compressed sealing washer, the S-BT HL studs must be installed with the appropriate depth gauge when using pneumatic setting tools. With the S-DG depth gauge the screw-in depth can be adjusted in a range of ~0 - 1.5 mm (~3 steps, 0.5 mm per step).

The S-CC BT calibration card is used to check the initial standoff of the S-BT HL stud and to adjust/calibrate the S-DG depth gauge (to ensure the correct screw-in depth). Once the correct setting level for the S-DG depth gauge has been found, the gauge can be set and the studs installed without further checking of the S-DG depth gauge. For more information, see the S-DG BT depth gauge instruction manual.

The correct stud standoff must be checked and, if necessary, the depth gauge re-adjusted (calibrated) at the following times:



Pneumatic drilling tools



Pneumatic setting tool



S-DG BT mechanical depth gauge

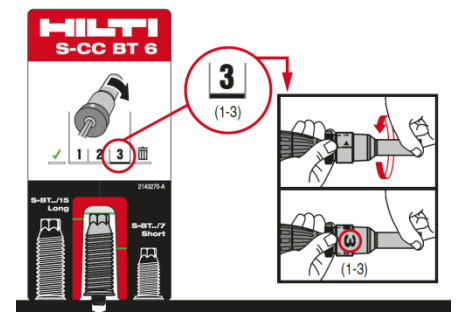

Design and functionality of the mechanical calibration card S-CC BT

- Start of the installation process
- Change of the working position (upwards, downwards, horizontal) and base material (thickness, strength, type)
- Installer change
- After each packaging respectively after the installation of 100 S-BT studs

The installer is responsible for the correct setting of the S-BT HL studs. For the periodical verification of the correct stud standoff the S-CG BT HC check gauge or S-CC BT 6 calibration card can be used.

**Note:**

The above-mentioned pneumatic drilling and setting tools are not covered by the approvals mentioned in section 7. The published performance data in sections 2.7 and 3.2 remain unchanged. The maximum coating thickness of the base material is 0.8 mm.



Design and functionality of the check gauge S-CG BT

## 6 ORDERING INFORMATION

Designation	Item no.	Description	Comment	Application
S-BT-GF M8/7 AN 6 HL	2345766	Threaded stud	use with X-FCM grating disc	Grating
S-BT-MF M8/7 AN 6 HL	2345768	Threaded stud		
S-BT-MF M8/15 AN 6 HL	2345769	Threaded stud	package includes serrated flange nut	Multipurpose
S-BT-MF M10/15 AN 6 HL	2346060	Threaded stud		
S-BT-MF W10/15 AN 6 HL	2346061	Threaded stud		
S-BT-MF MT M10/15 AN 6 HL	2350549	Threaded stud	package includes serrated flange nut	Multipurpose
S-BT-MF MT W10/15 AN 6 HL	2350880	Threaded stud		
S-BT-GR M8/7 SN 6 HL	2345767	Threaded stud	use with X-FCM grating disc	Grating
S-BT-GR M8/7 SN 6 HL AL	2350548	Threaded stud		
S-BT-MR M8/7 SN 6 HL	2346062	Threaded stud		
S-BT-MR M8/15 SN 6 HL	2346063	Threaded stud		
S-BT-MR M10/15 SN 6 HL	2346064	Threaded stud		
S-BT-MR W10/15 SN 6 HL	2346065	Threaded stud	package includes serrated flange nut	Multipurpose
S-BT-MR M8/7 SN 6 HL AL	2346066	Threaded stud		
S-BT-MR M8/15 SN 6 HL AL	2346067	Threaded stud		
S-BT-MR M10/15 SN 6 HL AL	2346068	Threaded stud		
S-BT-MR W10/15 SN 6 HL AL	2346069	Threaded stud		
S-BT-EF M8/15 AN 6 HL	2346076	Threaded stud		
S-BT-EF M10/15 AN 6 HL	2346071	Threaded stud	package includes nuts and lock washers	Electrical connection
S-BT-EF W10/15 AN 6 HL	2346072	Threaded stud		
S-BT-EF M10 HC 120 HL	2346077	Threaded stud	package includes nuts, lock washers and conductor discs	Electrical connection High Current
S-BT-EF W10 HC 4/0 HL	2346078	Threaded stud		
S-BT-ER M8/15 SN 6 HL	2346073	Threaded stud		
S-BT-ER M10/15 SN 6 HL	2346074	Threaded stud	package includes nuts and lock washers	Electrical connection
S-BT-ER W10/15 SN 6 HL	2346075	Threaded stud		
S-BT-ER M10 HC 120 HL	2346079	Threaded stud	package includes nuts, lock washers and conductor discs	Electrical connection High Current
S-BT-ER W10 HC 4/0 HL	2346080	Threaded stud		
RC-MF-M8 47/35	2284786	Coupler M8	use with S-BT-MF M8	
RC-MF-M10 47/35	2284788	Coupler M10	use with S-BT-MF M10	
RC-MR-M8 47/35	2284789	Coupler M8	use with S-BT-MR M8	Multipurpose
RC-MR-M10 47/35	2284787	Coupler M10	use with S-BT-MR M10	
Adapter M8-MF 25	2268526	Standoff adapter		
Adapter M8-MF 50	2268527	Standoff adapter		
Adapter M8-MF 75	2268528	Standoff adapter		
Adapter M8-MF 100	2268529	Standoff adapter	Purchase M8 wide flange nut separately	
Adapter M8-MR 25	2268522	Standoff adapter		
Adapter M8-MR 50	2268523	Standoff adapter		
Adapter M8-MR 75	2268524	Standoff adapter		
Adapter M8-MR 100	2268525	Standoff adapter		
Adapter M10-MF 50	2281194	Standoff adapter		Fastening on insulated base materials or PFP-coated base materials
Adapter M10-MR 50	2281193	Standoff adapter		
Adapter M10-MR 75	2394867	Standoff adapter		
Adapter M10-MR 100	2394868	Standoff adapter		
Adapter W10-MF 50	2281192	Standoff adapter		
Adapter W10-MR 50	2281191	Standoff adapter		
Adapter W10-MR 75	2394869	Standoff adapter		
Adapter W10-MR 100	2395330	Standoff adapter		
Adapter M10-HC120 50	2407049	Standoff adapter	For combination with	
Adapter M10-HC120 100	2407820	Standoff adapter	S-BT-ER M10/15 SN 6 HL	
Adapter W10-HC4/0 50	2407821	Standoff adapter	For combination with	
Adapter W10-HC4/0 100	2407822	Standoff adapter	S-BT-ER W10/15 SN 6 HL	

Designation	Item no.	Product name	Comment	Application	
M8-F wide	2289918	Wide flange nut	use with adapter M8-MF	Multipurpose / Grating / Electrical connection	
M8-A4-70 wide	2289919	Wide flange nut	use with adapter M8-MR		
TS-BT 5.3-65 S	2346083	Stepped drill bit	for base material steel		
TS-BT 5.3-95 S	2346084	Stepped drill bit	for base material steel		
TS-BT 5.5-74 AL	2143138	Stepped drill bit	for base material aluminum		
TS-BT 5.3 HC 95	2407824	Decoater	for preparation of contact surface		Electrical connection High Current
TS-BT 31-95 PFP	2394865	Coating removal drill bit	for removal of the PFP-coating from the base material		
S-DG BT M8/7 Short 6	2279735	Depth gauge	for exact setting of the S-BT		
S-DG BT M8/15 Long 6	2148575	Depth gauge	for exact setting of the S-BT		
S-DG BT M10-W10/15 Long 6	2143261	Depth gauge	for exact setting of the S-BT		
S-CG BT HC	2208475	Check gauge	for verification of the stud standoff		
S-IC BT	2383883	Inspection card	for verification of the stud standoff		
S-CC BT 6	2143270	Calibration card	for calibration of the depth gauge for verification of the stud standoff		
S-SH BT M8	2361441	Stud holder	for exact setting of the S-BT HL with S-BT 6-22 tool		
S-SH BT M10/W10	2361442	Stud holder			
S-BT 1/4" – 5 Nm	2143271	Torque tool	manual torque tool (5 Nm)		
X-BT 1/4" – 8 Nm	2119272	Torque tool	manual torque tool (8 Nm)		
S-BT 1/4" – 16 Nm	2346085	Torque tool	manual torque tool (16 Nm)		
S-NS 13 C 95/3 1/4"	2149244	Nut setter	for serrated flange nut M8		
S-NS 15 C 95/3 1/4"	2149245	Nut setter	for serrated flange nut M10		
S-NSD 1/4" HKH 17	376703	Nut setter	for nut M10 (electrical connectors)		
S-NS 9/16" C 95/3 1/4"	2149246	Nut setter	for serrated flange nut W10		
S-NS 19 C 95/3 1/4"	2268521	Nut setter	for standoff adapters M8 and M10		
S-NS 23 C 95/3 1/4"	2407823	Nut setter	for standoff adapters M10-HC120 and W10-HC4/0		
Bored Plate MQZ-L9-R	304071	Bored plate	For increasing contact surface and/or centering of channel on standoff adapter		
Bored Plate MQZ-L9-R	304196	Bored plate			



## 7 APPROVALS

Approvals are subject to continuous changes related to code developments, product portfolio updates and new research results. Current approvals can be downloaded from Hilti website or from the websites of most Certification Bodies.

### 7.1 Offshore and Shipbuilding applications



- ABS – American Bureau of Shipping  
23-2361769-PDA
- DNV – Det Norske Veritas  
TAS00003NW
- LR – Lloyd's Register  
23161857TA
- BV – Bureau Veritas  
74271/A0 BV
- RINA Services S.p.A.  
FPE035023CS/001

### 7.2 Onshore and Industry applications



- EOTA – European Organisation for Technical Assessment  
ETA-23/0001
- ICC-ES – International Code Council - Evaluation Service  
ESR-4185
- UL – Underwriters Laboratories  
File E257069