

Begrænsning af omfanget af ETA-20/0989 (CFS-W P premium brandstopstape) vedrørende gulv- og vægarbejdsopgaver

Kære kunde

Vi må desværre oplyse dig om, at omfanget af ETA-20/0989 er begrænset som følger

- a. plastrør
- b. til EI 90 U/U
- c. konstruktionsgruppe 4 og 6 – udvendig diameter større end 110 mm

denne arbejdsopgave kan ikke længere bruges beskrevet på ETA

- side 24 og 25, 28 og 29 af 57 (punkt 8.3.4.1/8.3.4.2/8.3.4.5/8.3.4.6) og
- side 39 og 40, 42 og 43 af 57 (punkt 8.4.5.1/8.4.5.2/8.4.5.4/8.4.5.5).



Gregory Dillen
Head of Marketing
Business Unit Fire Protection
Hilti Corporation

Schaan, 2022-01-05

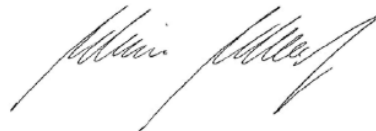

Martin Althof
Head of Quality
Business Unit Fire Protection
Hilti Corporation



Austrian Institute of Construction Engineering
Schenkenstrasse 4 | T+43 1 533 65 50
1010 Vienna | Austria | F+43 1 533 64 23
www.oib.or.at | mail@oib.or.at



European Technical Assessment

ETA-20/0989
of 17.03.2021

General part

Technical Assessment Body issuing the European Technical Assessment

Österreichisches Institut für Bautechnik (OIB)
Austrian Institute of Construction Engineering

Trade name of the construction product

Hilti Firestop Wrap CFS-W P

Product family to which the construction product belongs

Fire Stopping and Fire Sealing Products:
Penetration seals

Manufacturer

Hilti AG
Feldkircherstrasse 100
9494 Schaan
LIECHTENSTEIN

Manufacturing plant

Hilti production plant 4a
Hilti production plant 5a

This European Technical Assessment contains

57 pages including Annexes A to E which form an integral part of this assessment

This European Technical Assessment is issued in accordance with Regulation (EU) No 305/2011, on the basis of

European Assessment Document
EAD 350454-00-1104 "Fire stopping and fire sealing products – Penetration seals"

This European Technical Assessment replaces

European Technical Assessment ETA-20/0989
from 28.12.2020

This European Technical Assessment is not to be transferred to manufacturers or agents of manufacturer other than those indicated on page 1, or manufacturing plants other than those laid down in the context of this European Technical Assessment.

Translations of this European Technical Assessment in other languages shall fully correspond to the original issued document and should be identified as such.

Communication of this European Technical Assessment, including transmission by electronic means, shall be in full. However, partial reproduction can be made with the written consent of the Österreichisches Institut für Bautechnik. In this case, partial reproduction has to be designated as such.

This European Technical Assessment may be withdrawn by the Österreichisches Institut für Bautechnik, in particular pursuant to information by the Commission according to Article 25 (3) of Regulation (EU) No 305/2011.

electronic copy
electronic copy
electronic copy
electronic copy
electronic copy
electronic copy
electronic copy

Content

1	Technical description of the product	6
2	Specification of the intended use(s) in accordance with the applicable European Assessment Document (hereinafter EAD).....	6
2.1.	Intended use	6
2.2.	Use conditions.....	7
2.3.	Working life	7
2.4.	Manufacturing	7
3	Performance of the product and references to the methods used for its assessment	8
3.1.	Safety in case of fire (BWR 2)	8
3.1.1.	Reaction to fire	8
3.1.2.	Resistance to fire.....	8
3.2.	Hygiene, health and the environment (BWR 3).....	9
3.2.1.	Air permeability.....	9
3.2.2.	Water permeability	9
3.2.3.	Content, emission and/or release of dangerous substances.....	9
3.3.	Safety and accessibility in use (BWR 4)	9
3.3.1.	Mechanical resistance and stability	9
3.3.2.	Resistance to impact/movement.....	9
3.3.3.	Adhesion	9
3.3.4.	Durability	10
3.4.	Protection against noise (BWR 5).....	10
3.4.1.	Airborne sound insulation	10
3.5.	Energy economy and heat retention (BWR 6)	10
3.5.1.	Thermal properties	10
3.5.2.	Water vapour permeability.....	10
4	Assessment and verification of constancy of performance (hereinafter AVCP) system applied, with reference to its legal base.....	11
5	Technical details necessary for the implementation of the AVCP system, as provided for in the applicable EAD	12
6	ANNEX A - REFERENCE DOCUMENTS	13
7	ANNEX B - DESCRIPTION OF THE PRODUCT "HILTI FIRESTOP WRAP CFS-W P":.....	15
7.1.	Product Firestop Wrap CFS-W P.....	15
7.2.	Ancillary Product	15
7.3.	Use, maintenance, repair	15
8	ANNEX C - RESISTANCE TO FIRE CLASSIFICATION OF PENETRATION SEALS MADE OF "HILTI FIRESTOP WRAP CFS-W P"	16
8.1.	Overview intended use of pipes ¹ and reference to relevant section	16
8.2.	General Information "Hilti Firestop Wrap CFS-W P"	17

8.2.1. Penetration Seal (A ₁).....	17
8.2.2. Construction group (CG)	17
8.2.3. Seal installation and fixing	17
8.2.4. Pipe support construction	17
8.2.5. Sound decoupling insulation.....	18
8.2.6. Utilization of small wrap oddments	18
8.2.7. Pipe orientation	18
8.2.8. Distance between penetrations	18
8.2.9. Metal pipes.....	18
8.2.10. Foamed elastomeric insulation	19
8.2.11. Non-regulated Acoustic PP-Pipes.....	19
8.2.12. Installation of CFS-W P into big mortar seals (large openings)	20
8.3. Wall application	21
8.3.1. General description of flexible- / rigid walls ($t_E \geq 100$ mm)	21
8.3.2. Annular gap seal for wall penetration.....	22
8.3.3. Seal design variations (see classification for penetration systems).....	23
8.3.4. Assessed application with Hilti Firestop Wrap CFS-W P in flexible and rigid wall with standard number of layers (CG)	24
8.3.5. Assessed Application with Hilti Firestop Wrap CFS-W P in flexible and rigid wall with reduced number of layers (CG)	30
8.4. Rigid floor application	36
8.4.1. General information rigid floor ($t_E \geq 150$ mm).....	36
8.4.2. Mechanical support for CFS-W P application in rigid floor	36
8.4.3. Annular Gap Seal for Floor Penetrations	36
8.4.4. Seal design variations (see classification for penetration systems).....	38
8.4.5. Assessed Application with Hilti Firestop Wrap CFS-W P in rigid floor with standard number of layers (CG).....	39
8.4.6. Assessed Application with Hilti Firestop Wrap CFS-W P in rigid floor with reduced number of layers (CG).....	44
8.5. Shaftwall application.....	50
8.5.1. Suitable Shaft wall systems: 3 x 15 mm boards.....	50
8.5.2. Penetrating pipes	50
8.5.3. Annular Gap	51
8.5.4. Gap Filler in Shaft Walls	51
8.5.5. Firestop installation and wrap fixing.....	51
8.5.6. Pipe support	51
8.5.7. Pipe orientation	51
8.5.8. PE pipe insulation.....	51
8.5.9. Additional Protection Insulation	52

8.5.10. Zero distance pipe to pipe	53
9 ANNEX D - ABBREVIATIONS USED IN DRAWINGS	54
10 ANNEX E - INSTALLATION OF THE PRODUCT AND ANCILLARY PRODUCT(S).....	56

electronic copy

electronic copy

electronic copy

electronic copy

electronic copy

electronic copy

Specific parts

1 Technical description of the product

“Hilti Firestop Wrap CFS-W P” is a graphite-based pipe wrap used to reinstate the fire resistance performance of wall or floor constructions where they have been provided with apertures for the penetration of services.

“Hilti Firestop Wrap CFS-W P” is supplied as a 10 m long intumescent wrap with a width of 50 mm and a thickness of 2 mm. “The Hilti Firestop Wrap CFS-W P” is cut to the correct length specific to the pipe type and application.

“Hilti Firestop Wrap CFS-W P” is installed inside the annular gap between pipe and aperture edge so that the outer edge of the wrap is 5 mm outside with the wall/floor surface. In walls the wrap is installed on both sides, in floors only one wrap on the underside of the floor.

“Hilti Firestop Wrap CFS-W P” can be installed in conjunction with “Hilti Firestop Acrylic CFS-S ACR” which is subject to ETA-10/0292 and ETA-10/0389.

“Hilti Firestop Wrap CFS-W P” can be used in conjunction with mortar and gypsum to seal annular spaces up to 15 mm.

For a description of the installation procedure see Annex C of the ETA.

2 Specification of the intended use(s) in accordance with the applicable European Assessment Document (hereinafter EAD)

2.1. Intended use

“Hilti Firestop Wrap CFS-W P” is intended to form a part of a penetration seal, which is used to maintain the fire resistance of a separating element when and where services pass through. The specific elements of construction are as follows:

Construction-element	Construction
1. Rigid walls	The wall must have a minimum thickness 100 mm and comprise concrete, aerated concrete or masonry, with a minimum density of 550 kg/m ³ .
2. Rigid floors	The floors must have a minimum thickness of 150 mm and comprise concrete, aerated concrete or masonry, with a minimum density of 550 kg/m ³ .
3. Flexible walls	The wall must have a minimum thickness of 100 mm and comprise timber or steel studs lined on both faces with minimum 2 layers of 12,5 mm thick, ‘Type F’ Gypsum boards according to EN 520. For further details refer to Annex C, clause 8.3.1 of the ETA.

The supporting construction must be classified in accordance with EN 13501-2 for the required fire resistance period.

“Hilti Firestop Wrap CFS-W P” is intended to form a part of a penetration seal with plastic and insulated plastic pipes as single penetrations. For details on diameters, wall thicknesses, pipe materials, pipe standards and distances between seals see Annex C.

2.2. Use conditions

“Hilti Firestop Wrap CFS-W P” is intended for use at temperature below 0° C, but with no exposure to rain nor UV, and can therefore - according to EAD 350454-00-1104, clause 1.2.1 - be categorized as Type Y₂. Since the requirements for Type Y₂ are met, also the requirements for Type Z₁ and Z₂ are fulfilled.

2.3. Working life

The provisions made in this European Technical Assessment are based on an assumed working life of “Hilti Firestop Wrap CFS-W P” of 10 years, provided the conditions laid down in the technical literature of the manufacturer relating to packaging, transport, storage, installation, use and repair are met.

The indications given on the intended working life cannot be interpreted as a guarantee given by the producer or the Technical Assessment Body, but are to be regarded only as a means for selecting the appropriate product in relation to the expected economically reasonable working life of the works.

The real working life might be, in normal use conditions, considerably longer without major degradation affecting the Basic requirements for construction works.

2.4. Manufacturing

The European Technical Assessment is issued for the product on the basis of agreed data/information, deposited with the Österreichisches Institut für Bautechnik, which identifies the product that has been assessed and judged. Changes to the product or production process, which could result in this deposited data/information being incorrect, should be notified to the Österreichisches Institut für Bautechnik before the changes are introduced.

The Österreichisches Institut für Bautechnik will decide whether or not such changes affect the European Technical Assessment and consequently the validity of the CE marking on the basis of the European Technical Assessment and if so whether further assessment or alterations to the European Technical Assessment, shall be necessary.

3 Performance of the product and references to the methods used for its assessment

Basic requirements for construction works	Essential characteristic	Method of verification	Performance
BWR 2	Reaction to fire	EN 13501-1:2007	Clause 3.1.1 of the ETA
	Resistance to fire	EN 13501-2:2007	Clause 3.1.2 of the ETA
BWR 3	Air permeability	No performance assessed	
	Water permeability	No performance assessed	
	Content, emission and/or release of dangerous substances	EN 16516:2017	Clause 3.2.3
BWR 4	Mechanical resistance and stability	No performance assessed	
	Resistance to impact / movement	No performance assessed	
	Adhesion	No performance assessed	
	Durability	EOTA TR 024:2006	Clause 3.3.4 of the ETA
BWR 5	Airborne sound insulation	No performance assessed	
BWR 6	Thermal properties	No performance assessed	
	Water vapour permeability	No performance assessed	

3.1. Safety in case of fire (BWR 2)

3.1.1. Reaction to fire

“Hilti Firestop Wrap CFS-W P” is classified “E” in accordance with EN 13501-1.

3.1.2. Resistance to fire

“Hilti Firestop Wrap CFS-W P” has been tested in accordance with EN 1366-3: 2009 based upon the test results and the field of direct application specified within EN 1366-3: 2009, “Firestop Wrap CFS-W P” has been classified in accordance with EN 13501-2, as given in Annex C.

The seals may only be penetrated by the services described in Annex C; other parts or support constructions must not penetrate the seal.

The service support construction must be fixed to the building element containing the penetration seal or a suitable adjacent building element, in such a manner that in the case of fire, no additional load is imposed on the seal. Furthermore, it is assumed that the unexposed face support is maintained for the required period of fire resistance.

Pipes must be perpendicular to the seal surface.

It is assumed that compressed air systems are switched off by other means in the case of fire.

The function of the pipe seal in case of pneumatic dispatch systems, pressurised air systems etc. is guaranteed only when the systems are shut off in case of fire.

electronic copy

The assessment does not cover the avoidance of destruction of the seal or of the abutting building element(s) by forces caused by temperature changes in case of fire. This has to be considered when designing the piping system.

The assessment does not address any risks associated with leakage of dangerous liquids or gases caused by failure of the pipe(s) in case of fire.

The classifications relate to U/U (uncapped outside/uncapped inside the furnace) for plastic pipes/insulated plastic pipes and U/C (capped outside/uncapped inside the furnace) and for plastic pipes/insulated plastic pipes with reduced number of layers. For further information refer to national regulations.

The durability assessment does not take account of the possible effect of substances permeating through the pipe on the penetration seal.

3.2. Hygiene, health and the environment (BWR 3)

3.2.1. Air permeability

No performance assessed.

3.2.2. Water permeability

No performance assessed.

3.2.3. Content, emission and/or release of dangerous substances

"Hilti Firestop Wrap CFS-W P" was tested for SVOC and VOC according to EAD 350454-00-1104, clause 2.2.5.1, in accordance with EN 16516 with a loading factor of 0,007 m²/m³. Release scenario IA1 and IA2 have been tested.

The concentration of SVOC after 3 days and after 28 days was < 0,005 mg/m³. The concentration of the total emission of VOC after 3 days and after 28 days was, as well, < 0,005 mg/m³.

3.3. Safety and accessibility in use (BWR 4)

3.3.1. Mechanical resistance and stability

No performance assessed.

3.3.2. Resistance to impact/movement

No performance assessed.

3.3.3. Adhesion

No performance assessed.

3.3.4. Durability

“Hilti Firestop Wrap CFS-W P” has been tested in accordance with EOTA Technical Report TR024 for the intended use condition.

“Hilti Firestop Wrap CFS-W P” is therefore appropriate for use at temperature below 0° C, but with no exposure to rain nor UV, and can therefore - according to EAD 350454-00-1104, clause 2.2.9.3.1 - be categorized as Type Y₂.

3.4. Protection against noise (BWR 5)

3.4.1. Airborne sound insulation

No performance assessed.

3.5. Energy economy and heat retention (BWR 6)

3.5.1. Thermal properties

No performance assessed

3.5.2. Water vapour permeability

No performance assessed.

electronic copy
electronic copy
electronic copy
electronic copy
electronic copy
electronic copy
electronic copy

4 Assessment and verification of constancy of performance (hereinafter AVCP) system applied, with reference to its legal base

According to the Decision 1999/454/EC¹, amended by Decision 2001/596/EC² of the European Commission the system(s) of assessment and verification of constancy of performance (see Annex V of Regulation (EU) No 305/2011) is given in the following table.

Product(s)	Intended use(s)	Level(s) or class(es) (resistance to fire)	System of assessment and verification of constancy of performance
Fire Stopping and Fire Sealing Products	for fire compartmentation and/or fire protection or fire performance	any	1

In addition, according to the Decision 1999/454/EC, amended by Decision 2001/596/EC of the European Commission the system(s) of assessment and verification of constancy of performance, with regard to reaction to fire, is given the following table.

Product(s)	Intended use(s)	Level(s) or class(es) (reaction to fire)	System of assessment and verification of constancy of performance
Fire Stopping and Fire Sealing Products	For uses subject to regulations on reaction to fire	A1*, A2*, B*, C*	1
		A1**, A2**, B**, C**, D, E	3
		(A1 to E)***, F	4
<p>* Products/materials for which a clearly identifiable stage in the production process results in an improvement of the reaction to fire classification (e.g. an addition of fire retardants or a limiting of organic material)</p> <p>** Products/materials not covered by footnote (*)</p> <p>*** Products/materials that do not require to be tested for reaction to fire (e.g. products/materials of class A1 according to Commission Decision 96/603/EC, as amended)</p>			

¹ Official Journal of the European Communities no. L 178, 14.7.1999, p. 52

² Official Journal of the European Communities no. L 209, 2.8.2001, p. 33

5 Technical details necessary for the implementation of the AVCP system, as provided for in the applicable EAD

Technical details necessary for the implementation of the AVCP system are laid down in the control plan deposited with the Technical Assessment Body Österreichisches Institut für Bautechnik.

The notified product certification body shall visit the factory at least twice a year for surveillance of the manufacturer.

Issued in Vienna on 17.03.2021
by Österreichisches Institut für Bautechnik

The original document is signed by:

Rainer Mikulits
Managing Director

6 ANNEX A - REFERENCE DOCUMENTS

References to standards mentioned in the ETA

EN 1026	Windows and doors – Air permeability – Test method
EN 1329-1	Plastics piping systems for soil and waste discharge (low and high temperature) within the building structure - Unplasticized poly(vinyl chloride) (PVC-U)
EN 1366-3	Fire resistance tests for service installations - Part 3: Penetration seals
EN 1451-1	Plastics piping systems for soil and waste discharge (low and high temperature) within the building structure - Polypropylene (PP) – Part 1: Specifications for pipes, fittings and the system
EN 1453-1	Plastics piping systems with structured-wall pipes for soil and waste discharge (low and high temperature) inside buildings - Unplasticized poly(vinyl chloride) (PVC-U)
EN 1519-1	Plastics piping systems for soil and waste discharge (low and high temperature) within the building structure - Polyethylene (PE) - Part 1: Specifications for pipes, fittings and the system
EN 1566-1	Plastics piping systems for soil and waste discharge (low and high temperature) within the building structure - Chlorinated poly(vinyl chloride) (PVC-C) - Part 1: Specifications for pipes, fittings and the system
EN 12201-2	Plastics piping systems for water supply, and for drainage and sewerage under pressure - Polyethylene (PE) - Part 2: Pipes
EN 12666-1	Plastics piping systems for non-pressure underground drainage and sewerage – Polyethylene (PE) – Part 1: Specifications for pipes, fittings and the system
EN 13501	Fire classification of construction products and building elements – Part 1: Classification using test data from reaction to fire tests Part 2: Classification using test data from fire resistance tests, excluding ventilation services
EN ISO 1519	Paints and varnishes – Bend test (cylindrical mandrel)
EN ISO 1452-1	Plastics piping systems for water supply and for buried and above-ground drainage and sewerage under pressure - Unplasticized poly(vinyl chloride) (PVC-U)
EN ISO 15493	Plastics piping systems for industrial applications - Acrylonitrile-butadiene-styrene (ABS), unplasticized poly(vinyl chloride) (PVC-U) and chlorinated poly(vinyl chloride) (PVC-C) - Specifications for components and the system; Metric series
EN ISO 15494	Plastics piping systems for industrial applications - Polybutene (PB), polyethylene (PE) and polypropylene (PP) - Specifications for components and the system; Metric series
EN ISO 15874	Plastics piping systems for hot and cold water installations - Polypropylene (PP)
DIN 8061	Unplasticized polyvinyl chloride (PVC-U) pipes - General quality requirements and testing
DIN 8062	Unplasticized polyvinyl chloride (PVC-U) pipes - Dimensions
DIN 8074	Polyethylene (PE) - Pipes PE 80, PE 100 - Dimensions
DIN 8075	Polyethylene (PE) pipes - PE 80, PE 100 - General quality requirements, testing
DIN 8077	Polypropylene (PP) pipes - PP-H, PP-B, PP-R, PP-RCT – Dimensions
DIN 8078	Polypropylene (PP) pipes - PP-H, PP-B, PP-R, PP-RCT - General quality requirements and testing

- DIN 19531-10 Pipes and fittings made of unplasticized polyvinyl chloride (PVC-U) socket for waste and soil discharge systems inside buildings – Part 10: Fire behaviour, quality control and installation recommendations
- DIN 19535-10 High-density polyethylene (PE-HD) pipes and fittings for hot-water resistant waste and soil discharge systems (HT) inside buildings – Part 10: Fire behaviour, quality control and installation recommendations

Other reference documents

- EOTA TR 024 Characterisation, Aspects of Durability and Factory Production Control for Reactive Materials, Components and Products
- EAD 350454-00-1104 Fire stopping and fire sealing products: Penetration Seals

7 ANNEX B - DESCRIPTION OF THE PRODUCT “HILTI FIRESTOP WRAP CFS-W P”:

A detailed specification of the product is contained in document “Evaluation Report” relating to this European Technical Assessment ETA-20/0989 of “Hilti Firestop Wrap CFS-W P” which is a non-public part of this ETA.

7.1. Product Firestop Wrap CFS-W P

Hilti Firestop Wrap CFS-W P is a graphite-based pipe closure device installed around insulated and uninsulated plastic pipes to form a penetration seal designed to reinstate the fire resistance performance of wall and floor constructions, where they have been provided with apertures for the penetration of services.

Hilti Firestop Wrap CFS-W P is supplied as a 10 m roll, 50 mm wide and 2 mm thick and is cut to size to suit a specific pipe diameter. Depending on the pipe diameter several layers may be necessary – for details see Annex C, clause 8.2.2 (Layer groups).

7.2. Ancillary Product

- Hilti Firestop Acrylic Sealant CFS-S ACR – material: water based acrylic sealant
- Mortar
- Gypsum

7.3. Use, maintenance, repair

“Hilti Firestop Wrap CFS-W P” should be installed and used as described earlier in this document.

“Hilti Firestop Wrap CFS-W P” seals which are damaged should not be used or if damaged after installation, should be removed and replaced.

In the area covered by the ETA when the set up recommendation have been followed there is no maintenance protocol to be followed.

8 ANNEX C - RESISTANCE TO FIRE CLASSIFICATION OF PENETRATION SEALS MADE OF "HILTI FIRESTOP WRAP CFS-W P"

8.1. Overview intended use of pipes¹ and reference to relevant section

Application	Pipe Material	Pipe Standard	Insulation	For use in Flexible/ Rigid Wall see:	For use in Rigid Floor see:
Waste Water (U/U-Pipe end configuration)	PE	EN 1519-1	none	8.3.4.1	8.4.5.1
	PE-S2	Non-regulated (Geberit Silent dB20)	none	8.3.4.2	8.4.5.2
	PE	EN 15494	none	8.3.4.4	Not available
	PP	Non-regulated	none	8.3.4.5	8.4.5.4
	PVC	EN 1452-1	none	8.3.4.6	8.4.5.5
Waste Water + Industrial piping (U/C-Pipe end configuration)	PE	EN 1519-1	none	8.3.5.1	8.4.6.1
	PE-S2	Non-regulated (Geberit Silent dB20)	none	8.3.5.2	8.4.6.2
	PE	EN 15494	none	8.3.5.3	8.4.6.4
	PP	Non-regulated	none	8.3.5.5	8.4.6.5
	PVC	EN 1452-1	none	8.3.5.6	8.4.6.6
Roof Drainage (U/U-Pipe end configuration)	PE	EN 1519-1	Elastomer	8.3.4.3	8.4.5.3
Roof Drainage (U/C-Pipe end configuration)	PE	EN 1519-1	Elastomer	8.3.5.4	8.4.6.3

¹ According to technical literature of pipe manufacturers

8.2. General Information “Hilti Firestop Wrap CFS-W P”

8.2.1. Penetration Seal (A₁)

Hilti Firestop Wrap CFS-W P (A₁) to be mounted on both sides of the wall or on soffit side of floor only. The wrap A₁ should be positioned mainly into the wall/floor opening; only 5 mm of the wrap A₁ are still visible around sealed pipes, coming out of the wall/floor surface in an identical matter.

8.2.2. Construction group (CG)

The relevant construction group is defined by the number of layers of CFS-W P, wrapped tightly around the penetrating service. There is no space in between the layers and no space between the inner layer and the surface of the penetrating pipes.

Number of layers of CFS-W P	Corresponding Construction Group (CG)
1	CG 1
2	CG 2
3	CG 3
4	CG 4
5	CG 5
6	CG 6

For detailed information related to assessed item combination (pipe/isolation and designated construction group) refer to clauses 8.3, 8.4, 8.5 of the ETA.

8.2.3. Seal installation and fixing

The Hilti Firestop Wrap CFS-W P (A₁) should be wrapped closely around the prior installed and insulated pipe. There must be no gap between the pipe/pipe insulation and the wrap (A₁) and no gap between the single layers of the wrap (A₁). Number of layers to be installed follow the designated construction group (CG), refer to clause 8.2.2. The end of the wrap (A₁) should be secured by using a small piece of adhesive strip. There should be an overlap of the wrap (A₁) by appr. 10 mm. Than the twisted wrap should be moved for 45 mm depth into the basement. If requested (refer to clause 8.4) the necessary number of metallic hooks (F) should be installed (refer to clause 8.4.2). Finally, the gap seal should be applied. Remaining 5 mm of the wrap (A₁) are still visible around the penetrating pipes.

8.2.4. Pipe support construction

Installed penetrants must be supported on both sides of the wall / on top side of the floor only. First support is max. 250 mm from basement in wall and floor application.

8.2.5. Sound decoupling insulation

Plastic pipes could be with or without sound decoupling insulation C_1 .

Assessed material:

- Foamed polyethylene-based (PE) sound decoupling insulation, thickness (4 mm - 9 mm)
- ThermoVlies B2 (Polyester), thickness 4 mm
- LS- situation, installed inside the wall and below the CFS-W P only

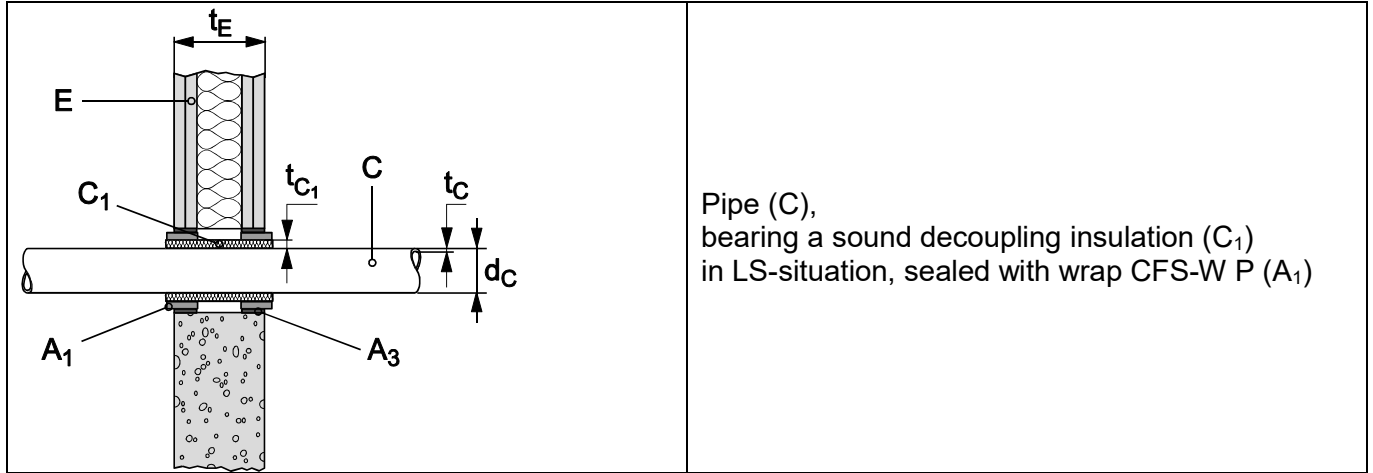

8.2.6. Utilization of small wrap oddments

No oddments of Hilti Firestop Wrap CFS-W P (A_1) should be used / combined.

8.2.7. Pipe orientation

Penetrants should penetrate wall / floor constructions in a perpendicular way only (90°). No inclined penetrants are assessed.

8.2.8. Distance between penetrations

Distance between single penetration seals (openings) $s_1 \geq 200$ mm in wall and floor. For some applications smaller distances have been assessed. For details refer to clauses 8.3, 8.4 and 8.5.

8.2.9. Metal pipes

The field of application given for copper pipes is also valid for pipes made of other materials with lower heat conductivity than copper and a melting point of minimum 1050°C , e.g. unalloyed steel, low alloyed steel, cast iron, stainless steel, Ni-alloys (NiCu, NiCr, NiMo-alloys and Ni).

8.2.10. Foamed elastomeric insulation

The following types of foamed elastomeric insulation material may be used in direct contact ($s_1 \geq 0$ mm) to Hilti Firestop Wrap CFS-W P (A₁):

Producer / Seller	Assessed Type of foamed elastomeric thermal isolation
Armacell GmbH	Armaflex - Type: AF, SH, Ultima, HT, XG, NH
NMC Group	Insul-Tube (nmc), Insul-Tube H-Plus (nmc), Aeroflex HF
Kaimann GmbH	Kaiflex KK plus, Kaiflex KK, HF plus, EPDM plus
L'Isolante K-Flex	l'Isolante K-Flex - Type: HT, ECO, ST, H, ST Plus, ST Frigo
CONEL GmbH	Conel Flex HT
Union Foam AG	Eurobatex
A.Würth GmbH & Co.KG	Flexen
3i Intern. Innovative Industries S.A.	Isopipe HT
Isidem / Yalitim	Coolflex AF
ODE	R-flex RPM

Named material may be used in form of a pipe insulation hose, bandage/wrap or plates. If a protection insulation DP has to be used, it should be made of the same elastomeric material as the thermal pipe isolation itself.

8.2.11. Non-regulated Acoustic PP-Pipes

The following types of mineral reinforced non-regulated PP-pipes were assessed:

- Coes Blue Power
- Coes PhoNo Fire
- Conel Drain Hausabflussrohr
- Geberit Silent PP
- Geberit Silent Pro
- GF Silenta Premium
- KE KELIT PhonEx AS
- Marley Silent
- Ostendorf Skolan db
- Pipelife Master 3
- Poloplast Polokal NG
- Poloplast Polokal 3S
- Poloplast Polokal XS
- Rehau Raupiano Plus
- Valsir Silere
- Valsir Triplus
- Wavin AS
- Wavin SiTech
- Wavin SiTech +
- Uponor S&W Decibel

8.2.12. Installation of CFS-W P into big mortar seals (large openings)

Hilti Firestop Wrap may be installed into big mortar seals in rigid walls and floors too. The following preconditions should be given:

- Application should be done in rigid walls and floors only.
- Mortar seal thickness is bigger or equal than indicated in clauses 8.3 and 8.4.
- Mortar seal density is bigger or equal 550 kg/m^3 , but lower than 1570 kg/m^3 (density of cured CP 633 Hilti Firestop mortar).
- Type of used mortar: any normal gypsum, lime - or cement-based mortars with a compression strength lower or equal than 10 N/mm^2 .
- The maximum size of the mortar seal is identical as tested or covered by the field of application as mentioned in the relevant fire resistance tests acc. EN 1366-3 and classification reports acc. EN 13501-2.
- Pipe type, brand, material, insulation, dimension and pipe-end configuration should be in accordance to the assessed fields of application, refer to clauses 8.3 and 8.4.
- Penetrants must be installed in a perpendicular matter into the supporting construction.

8.3. Wall application

8.3.1. General description of flexible- / rigid walls ($t_E \geq 100$ mm)

Flexible walls:

The wall must have a minimum thickness of 100 mm and comprise timber or steel studs lined on both faces with minimum 2 layers of 12,5 mm thick boards.

For timber stud walls there must be a minimum distance of 100 mm of the seal to any stud and the cavity between stud and seal must be closed. A minimum 100 mm insulation of Class A1 or A2 (in accordance with EN 13501-1) has to remain in the cavity between stud and seal. In steel stud construction the space between linings has not to be completely filled with insulation material, especially in the neighbourhood to the seal. Nevertheless, the wall construction has to be set up according requirements given in EN 1366-3:2009 or the construction itself has been classified according EN 13501-2.

The wall comprises timber or steel studs lined on both faces with minimum 2 layers of 12,5 mm thick boards. A higher number of board layers are accepted if the overall board layer thickness is equal or bigger than tested. A higher overall board layer thickness is accepted, if the number of board layers is equal or bigger than tested.

The boards are according EN 520 type F or according the specification of the tested and assessed flexible wall construction system according EN 13501-2.

An aperture framing inside the wall is not required.

Rigid walls:

The wall must have a minimum thickness 100 mm and comprise concrete, aerated concrete or masonry, with a minimum density of 550 kg/m³.

8.3.2. Annular gap seal for wall penetration

Sealing A in flexible and rigid walls:

- With Hilti Firestop Acrylic Sealant CFS-S ACR
- To be done at both sides of the wall, flush to the surface
- Annular gap width: ($0 \leq s_1 \leq 15$) mm
- Annular gap depth t_{A2} : min 10 mm
- No backfilling needed

Sealing B in flexible and rigid walls:

- With gypsum or mortar
- To be done at both sides of the wall, flush to the surface
- Annular gap width: ($0 \leq s_1 \leq 15$) mm
- Annular gap depth t_{A2} : min 25 mm
- No backfilling needed

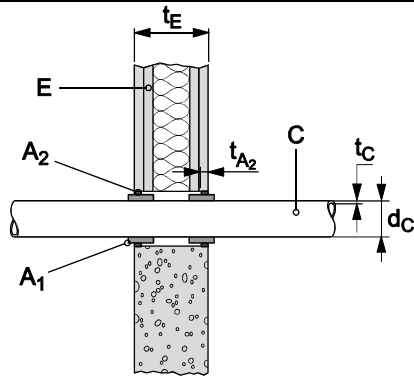
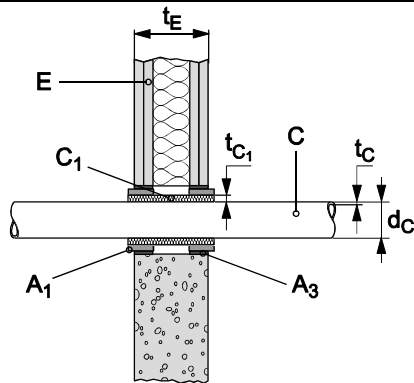
<p>Annular Gap Sealing A:</p> <p>Plastic Pipe (C) seal in rigid or flexible wall (E), gap seal (A_2) done with acrylic sealant CFS-S ACR around the wrap seal (A_1)</p>	
<p>Annular Gap Sealing B:</p> <p>Plastic Pipe (C) seal in rigid or flexible wall (E), gap seal (A_3) done with acrylic sealant CFS-S ACR around the wrap seal (A_1). An additional sound decoupling (t_{c1}) has been installed inside the wall around the pipe.</p>	

8.3.3. Seal design variations (see classification for penetration systems)

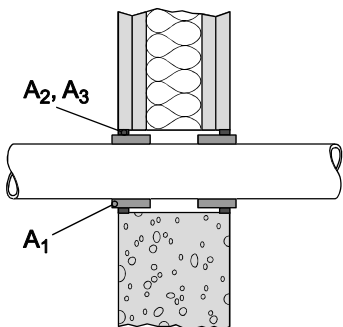
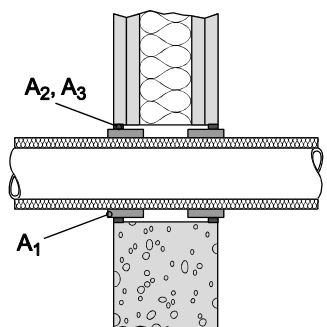
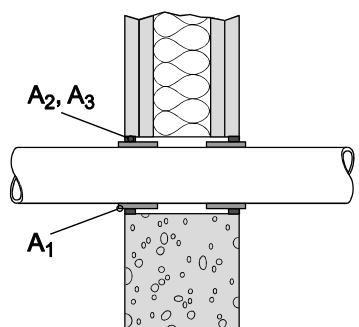
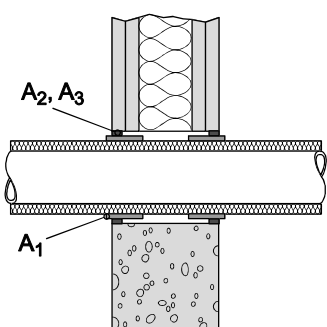
Seal design type		Sealing product (A ₁)	Annular sealing (A ₂ , A ₃)	Principle drawings
i)	Uninsulated Plastic Pipe (standard) in U/U pipe-end configuration,	Standard number of layers	Acrylic sealant CFS-S ACR or gypsum plaster	8.3.3.A) 
ii)	Insulated Plastic Pipe (standard) in U/U pipe-end configuration	Standard number of layers	Acrylic sealant CFS-S ACR or gypsum plaster	8.3.3.B) 
iii)	Uninsulated Plastic Pipe (reduced) in U/C pipe-end configuration	reduced number of layers	Acrylic sealant CFS-S ACR or gypsum plaster	8.3.3.C) 
iv)	Insulated Plastic Pipe (reduced) in U/C pipe-end configuration	reduced number of layers	Acrylic sealant CFS-S ACR or gypsum plaster	8.3.3.D) 

8.3.4. Assessed application with Hilti Firestop Wrap CFS-W P in flexible and rigid wall with standard number of layers (CG)

8.3.4.1. PE pipes according to EN 1519-1, EN 12666-1, EN 12201-2

EI 90-U/U, Seal design: i) according to clause 8.3.3

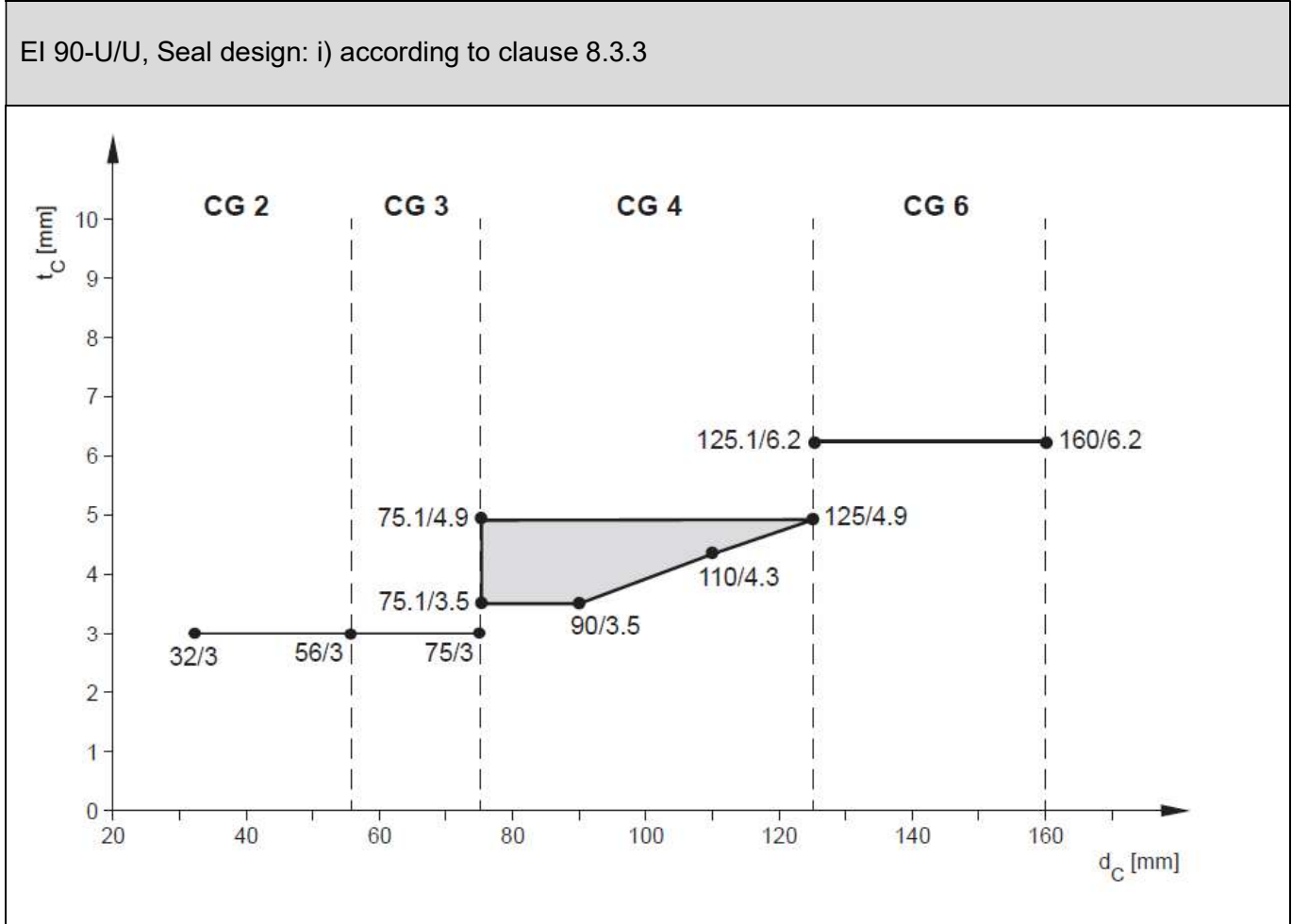

8.3.4.2. PE-S2 pipes, designation “Geberit Silent dB20”

EI 90-U/U, Seal design: i) according to clause 8.3.3

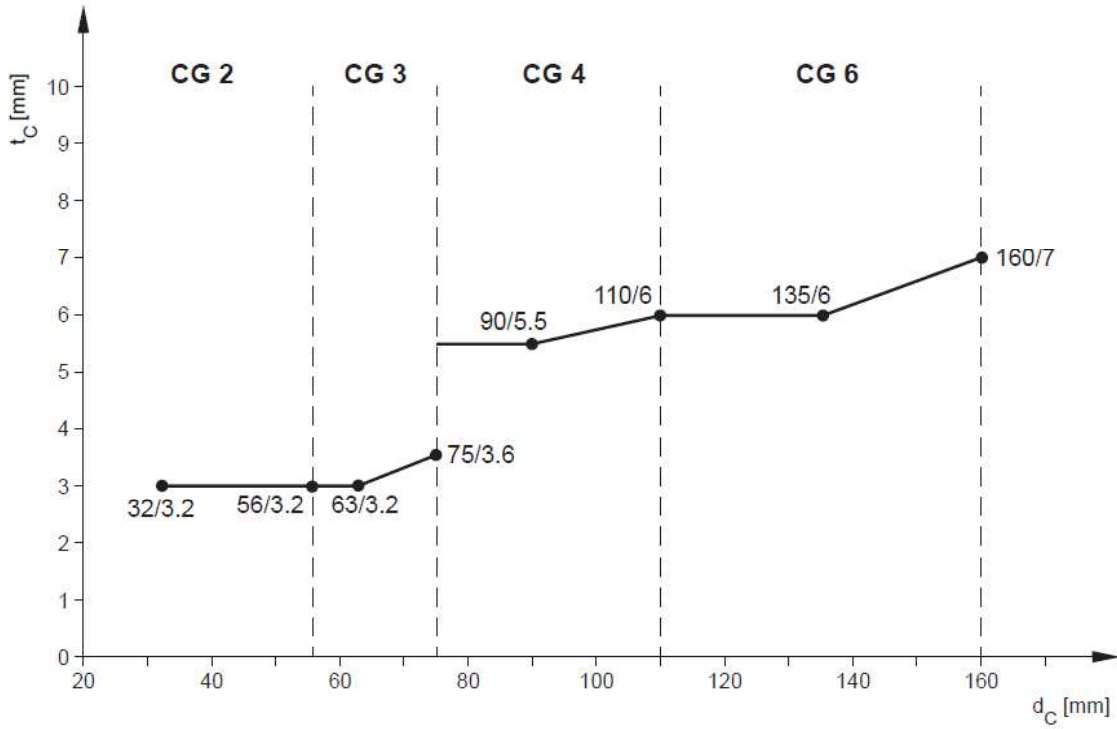

8.3.4.3. Insulated PE pipes according to EN 1519-1, EN 12666-1, EN 12201-2

EI 90-U/U, Seal design: ii) according to clause 8.3.3

Insulation in CS-position

Assessed insulation brands and manufacturers: refer to clause 8.2.10

Pipe wall thickness: for CG 2: 3 mm; for CG 4: 3 mm; for CG 5: (3,5 – 4,3) mm

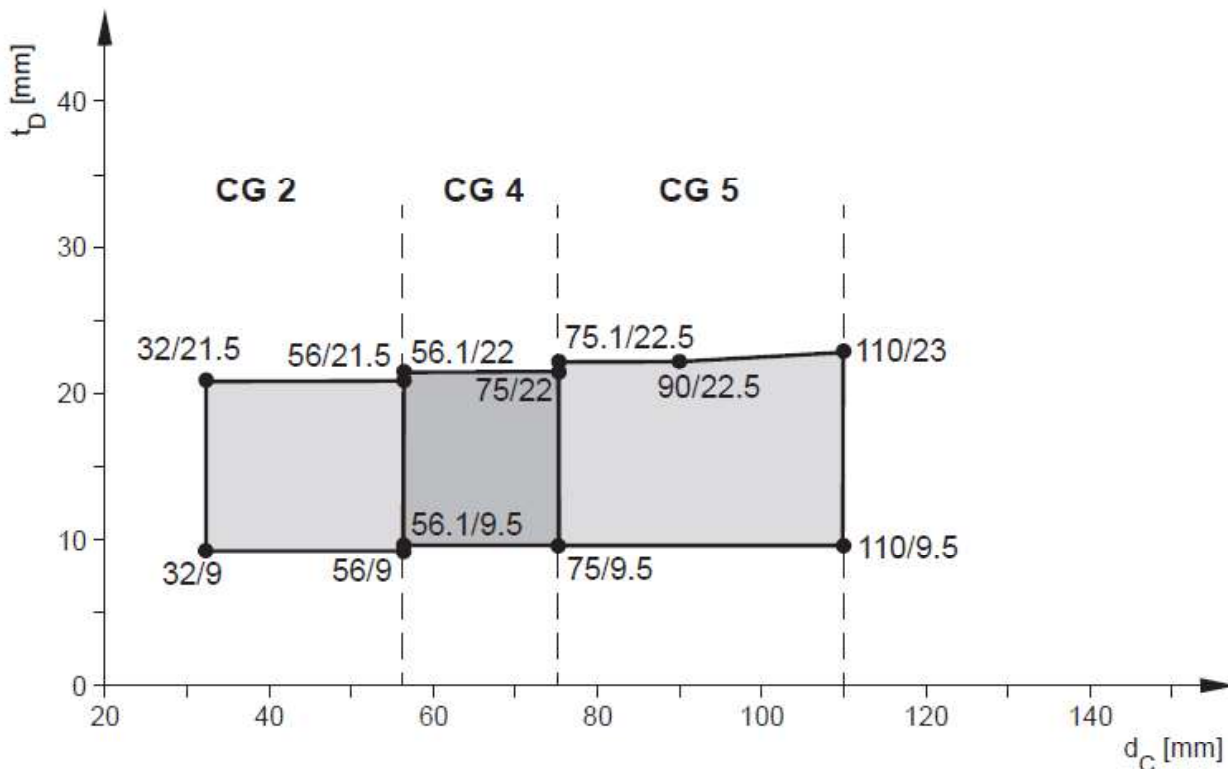

8.3.4.4. PE pipes, according EN 15494

EI 90- U/C, Seal design: i) according to clause 8.3.3

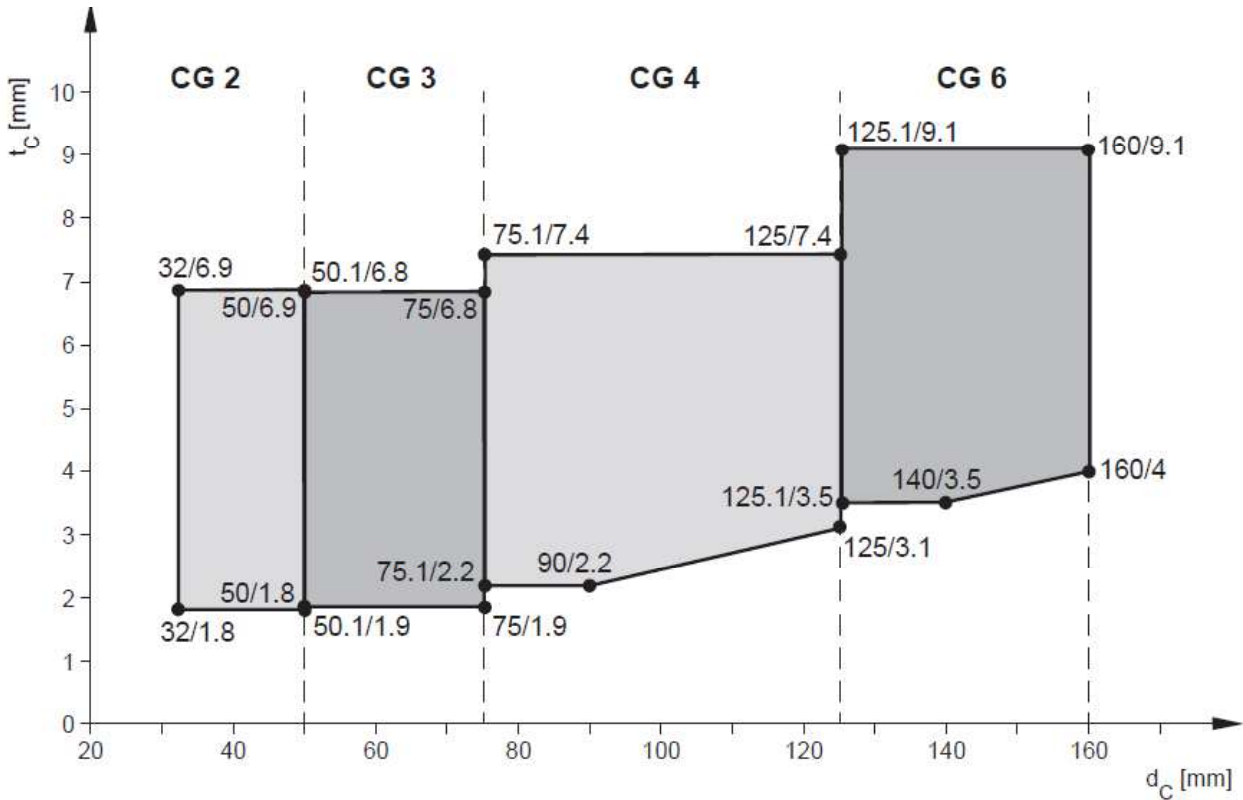

8.3.4.5. PP pipes, non-regulated

EI 90- U/U, Seal design: i) according to clause 8.3.3
 Assessed pipe brands and manufacturers: refer to clause 8.2.11

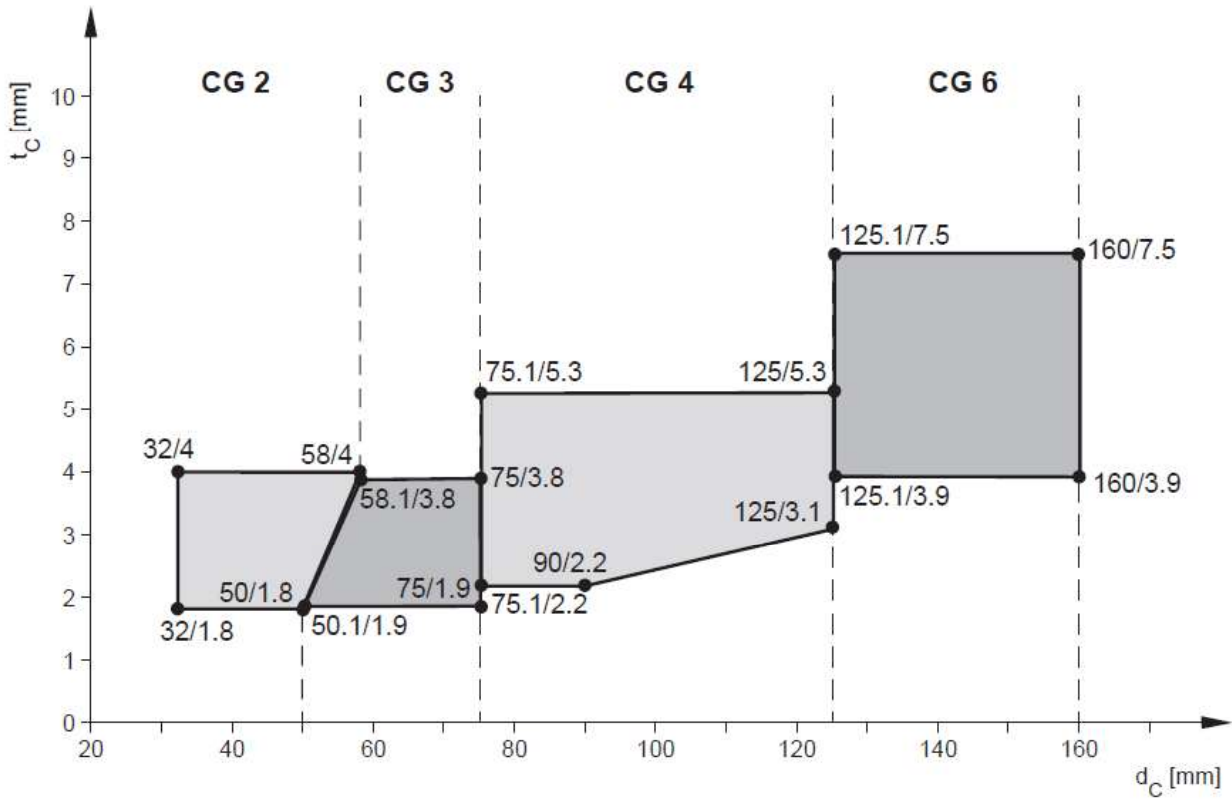

**8.3.4.6. PVC pipes according to EN ISO 1452-1, (covers EN 1329-1, EN 1453-1, EN 1566-1),
 EN ISO 15493 (Industrial, equivalent EN 1452)**

EI 90- U/U, Seal design: i) according to clause 8.3.3

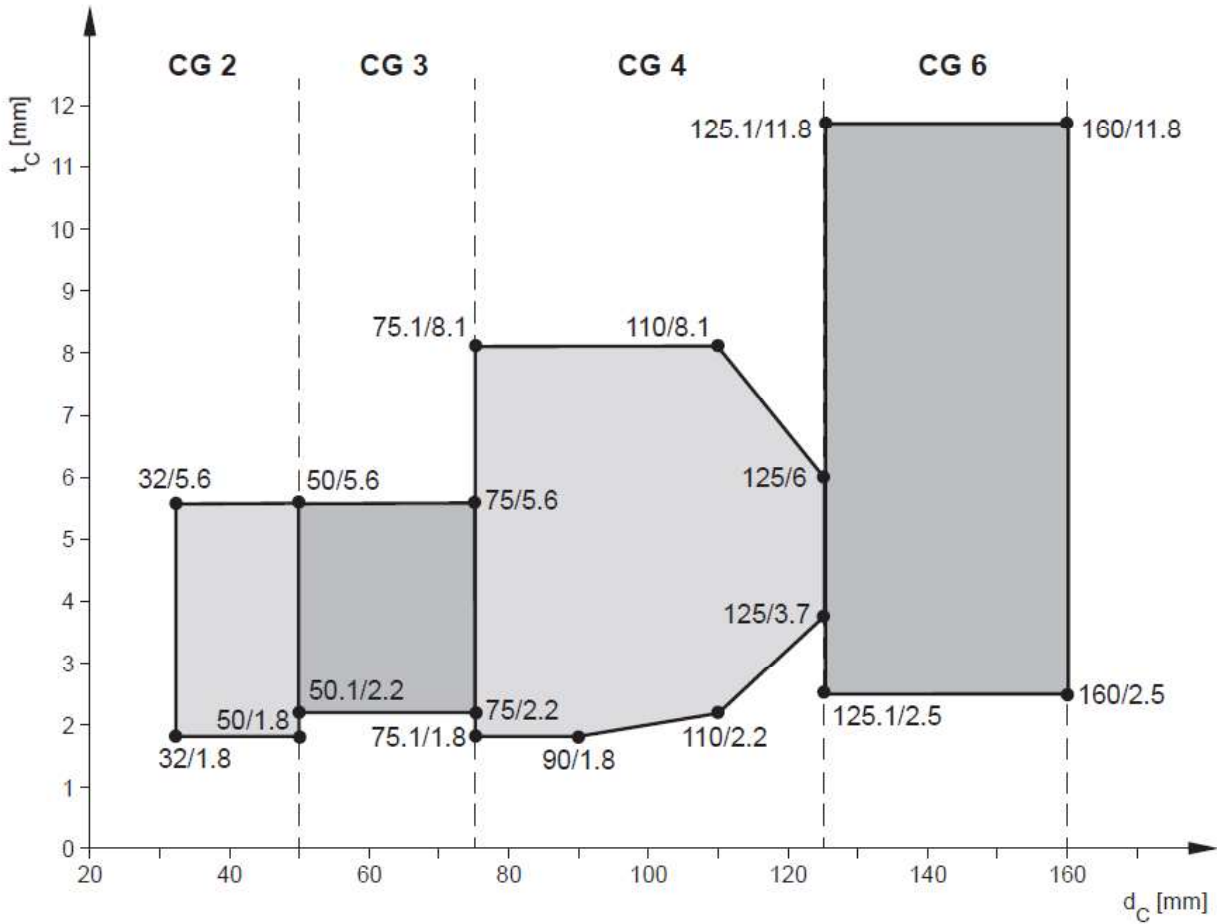

8.3.5. Assessed Application with Hilti Firestop Wrap CFS-W P in flexible and rigid wall with reduced number of layers (CG)

8.3.5.1. PE pipes according to EN 1519-1, EN 12666-1, EN 12201-2 (reduced number of layers)

EI 90-U/C, Seal design: iii) according to clause 8.3.3

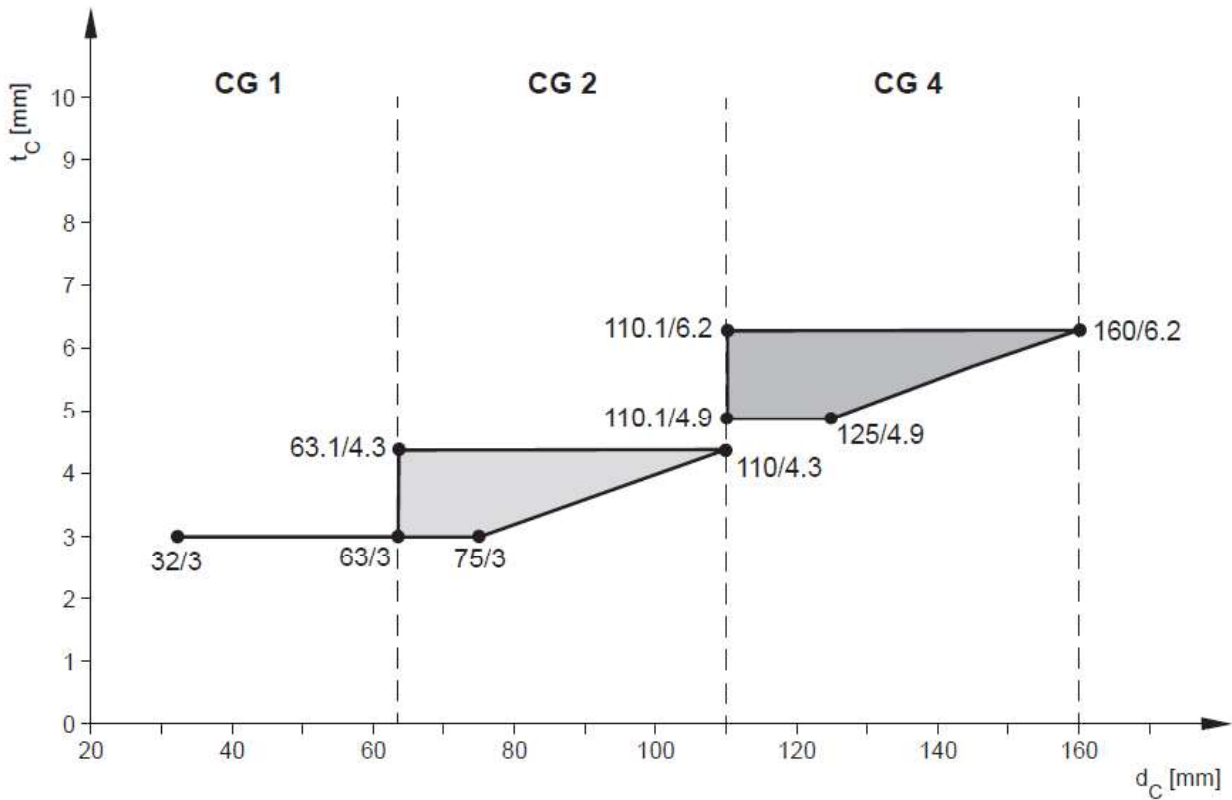

8.3.5.2. PE-S2 pipes (Geberit Silent dB20) (reduced number of layers)

EI 90-U/C, Seal design: iii) according to clause 8.3.3

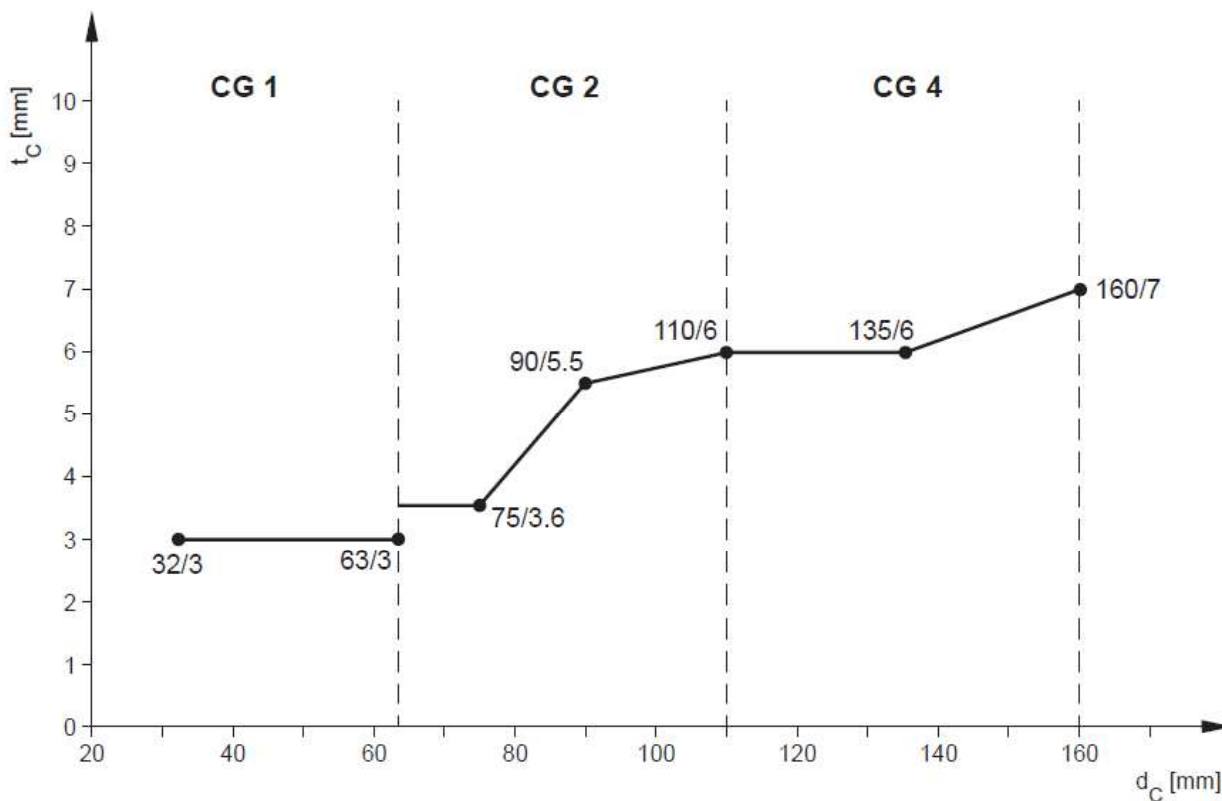

8.3.5.3. PE-pipes according EN ISO 15494 (reduced number of layers)

EI 90-U/C, Seal design: iii) according to clause 8.3.3

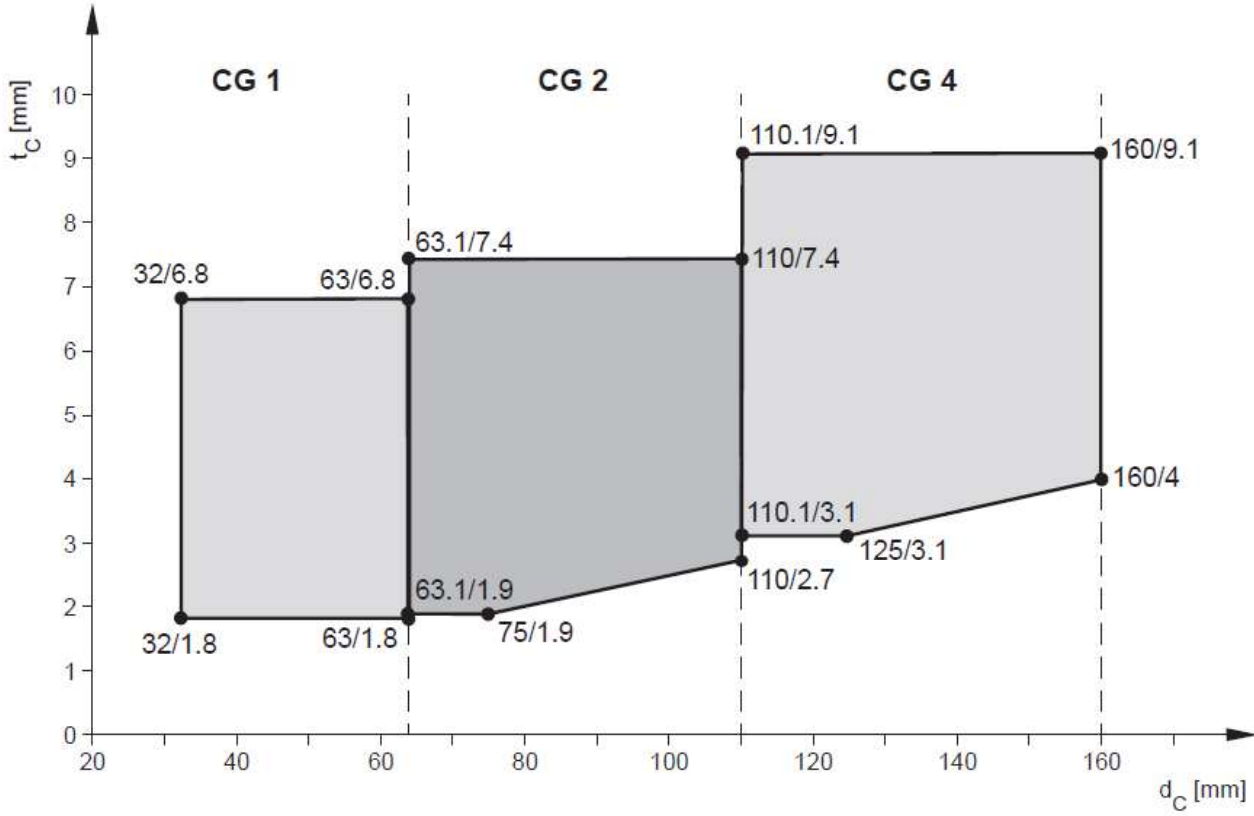

8.3.5.4. Insulated PE pipes according to EN 1519-1, EN 12666-1, EN 12201-2 (reduced number of layers)

EI 90- U/C, Seal design: iv) according to clause 8.3.3

Insulation in CS-position

For brands and manufacturers of assessed elastomeric pipe insulation: refer to clause 8.2.10

Pipe wall thickness: for CG 1: 3,0 mm; for CG 2: (3,0 – 4,3) mm

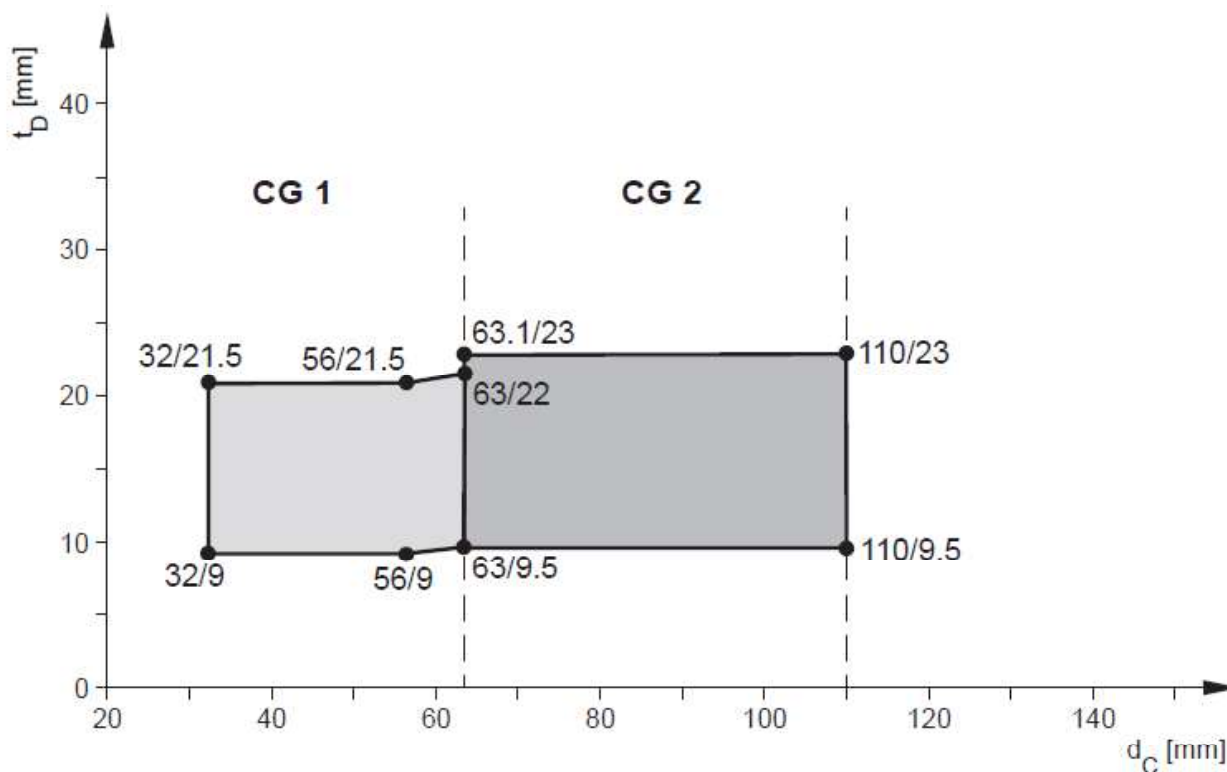

8.3.5.5. PP pipes, non-regulated (reduced number of layers)

EI 90-U/C, Seal design: iii) according to clause 8.3.3

For assessed pipe brands and manufacturer: refer to clause 8.2.11

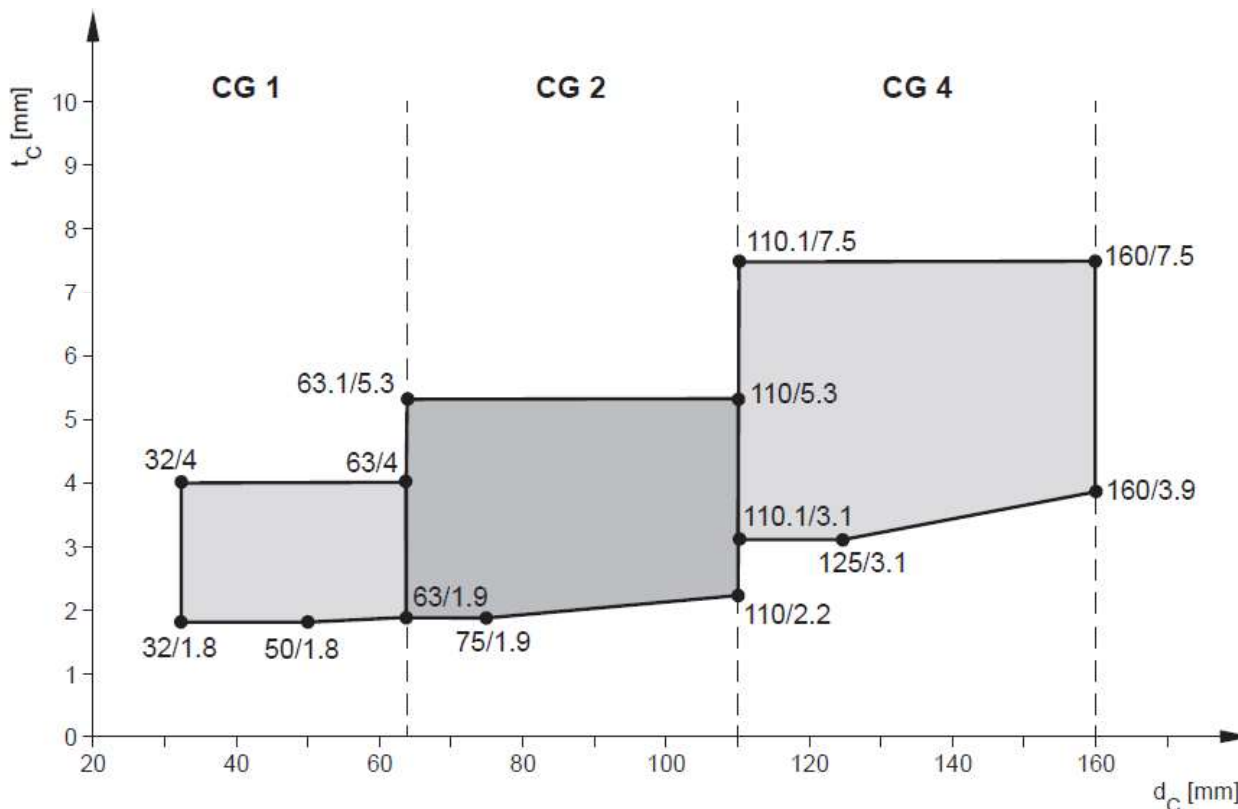

**8.3.5.6. PVC pipes according to EN ISO 1452-1, (covers EN 1329-1, EN 1453-1, EN 1566-1),
EN ISO 15493 (Industrial, equivalent to EN 1452), (reduced number of layers)**

EI 90-U/C, Seal design: iii) according to clause 8.3.3

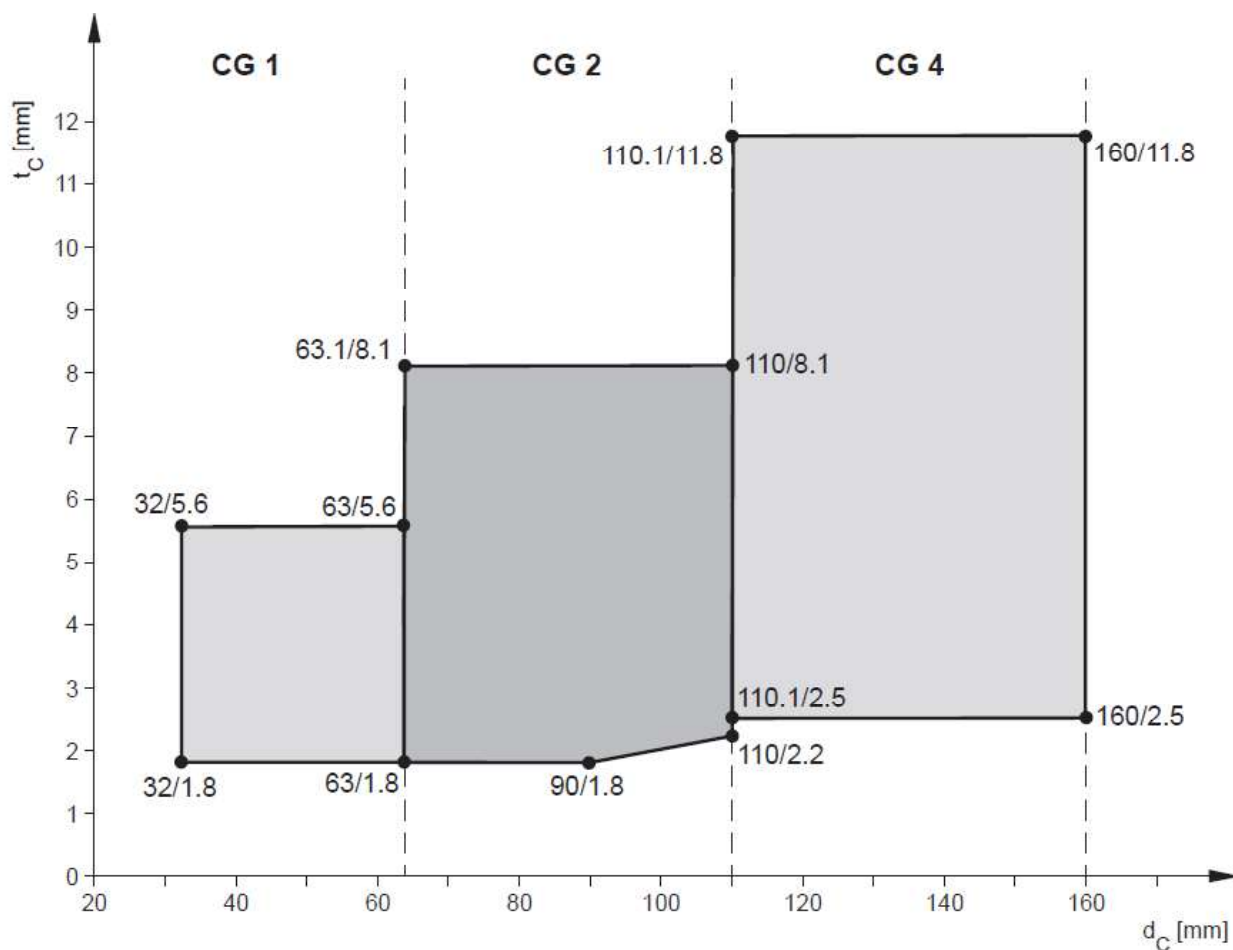

8.4. Rigid floor application

8.4.1. General information rigid floor ($t_E \geq 150$ mm)

The floor must have a minimum thickness of 150 mm with a minimum density of $\rho_E \geq 550$ kg/m³ and comprise concrete, aerated concrete or masonry.

8.4.2. Mechanical support for CFS-W P application in rigid floor

In some specific cases (refer to clause 8.4.4 "Seal Design") Hilti Firestop Wrap CFS-W P is supported by means of steel plate Z-profiles (F) with a thickness of 0,5 mm and a width of 20 mm.

Position of the Z-profiles:

- The small horizontal section supports the Wrap CFS-W P (A₁), hold them in place
- the vertical section is placed into the annular gap seal over a depth of 120 mm.

Number of Z-profiles:

- Pipe $\varnothing \leq 75$ mm = 2 Z-profiles
- Pipe $\varnothing > 75$ mm = 3 Z-profiles

The installed Z-profiles are fixed in the gap by the incombustible gap filler or mineral wool.

8.4.3. Annular Gap Seal for Floor Penetrations

Sealing A in rigid floors:

- With Hilti Firestop Acrylic Sealant CFS-S ACR
- To be done at both sides of the floor, flush to the surface
- Annular gap width: ($0 \leq s_1 \leq 15$) mm
- Annular gap depth: min 10 mm
- backfilling needed, mineral wool over remaining depth

Sealing B in rigid floors:

- With mortar acc. EN 998-2, group M10
- Annular gap width: ($0 \leq s_1 \leq 15$) mm
- Annular gap depth: over the entire floor thickness
- No backfilling

Annular Gap Sealing A:

8.4.3.A)

Pipe (C) seal in rigid floor (E), gap seal (A_4) done with mortar. Metal hooks (F) are fixed within the wet mortar, holding the wrap seal (A_1), with and without sound decoupling insulation (C_1)

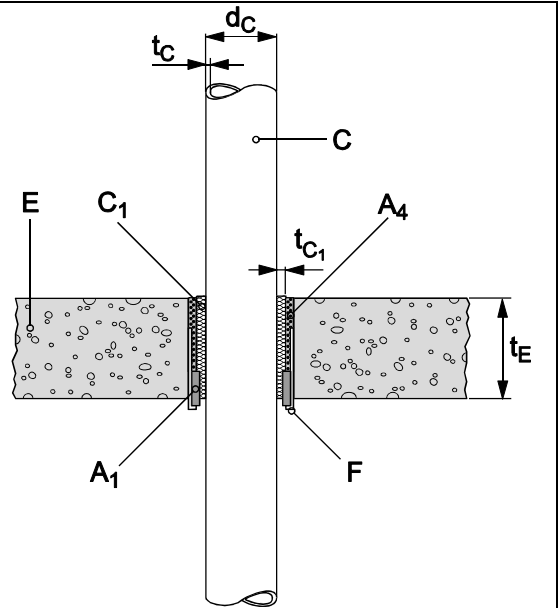

Annular Gap Sealing B:

8.4.3.B)

Pipe (C) seal in rigid floor (E), gap seal (A_2) done with acrylic sealant CFS-S ACR. Metal hooks (F) are fixed within the mineral wool (B), - used as back filler – supporting the wrap seal (A_1).

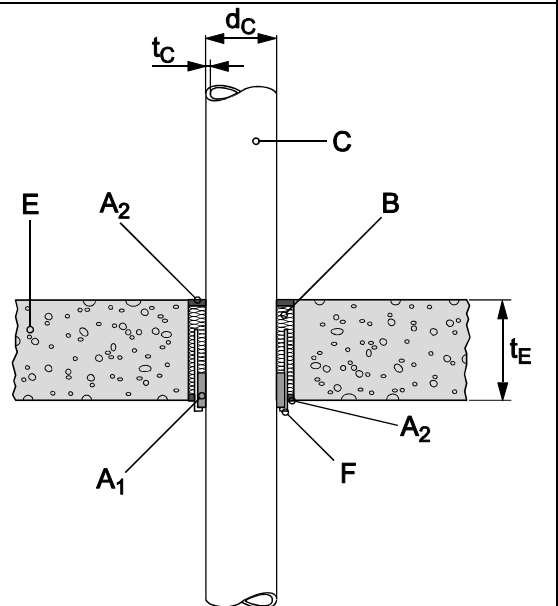

8.4.4. Seal design variations (see classification for penetration systems)

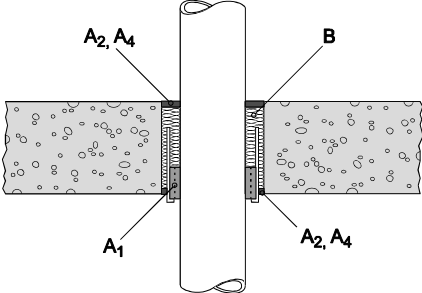
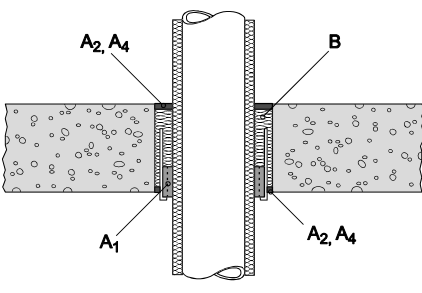
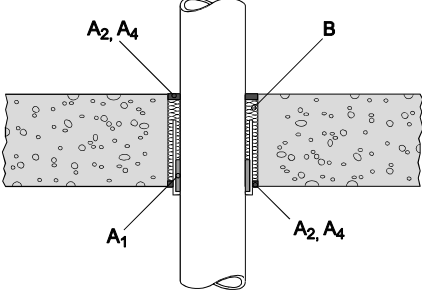
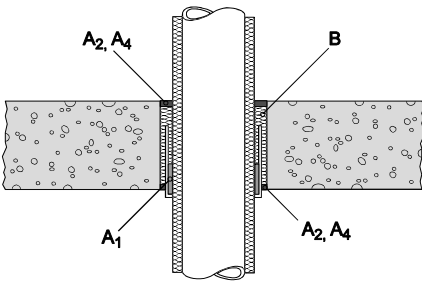
Seal design type		Sealing product (A ₁)	Annular sealing (A ₂ , A ₄ , B)	Principle drawings
i)	Uninsulated Plastic Pipe (standard) in U/U pipe-end configuration	Standard number of layers	Acrylic sealant CFS-S ACR or mortar	8.4.4.A) 
ii)	Insulated Plastic Pipe (standard) in U/U pipe-end configuration	Standard number of layers	Acrylic sealant CFS-S ACR or mortar	8.4.4.B) 
iii)	Uninsulated Plastic Pipe (reduced) in U/C pipe-end configuration	reduced number of layers	Acrylic sealant CFS-S ACR or mortar	8.4.4.C) 
iv)	Insulated Plastic Pipe (reduced) in U/C pipe-end configuration	reduced number of layers	Acrylic sealant CFS-S ACR or mortar	8.4.4.D) 

8.4.5. Assessed Application with Hilti Firestop Wrap CFS-W P in rigid floor with standard number of layers (CG)

8.4.5.1. PE pipes according to EN 1519-1, EN 12666-1, EN 12201-2

EI 90-U/U, Seal design: i) according to clause 8.4.4

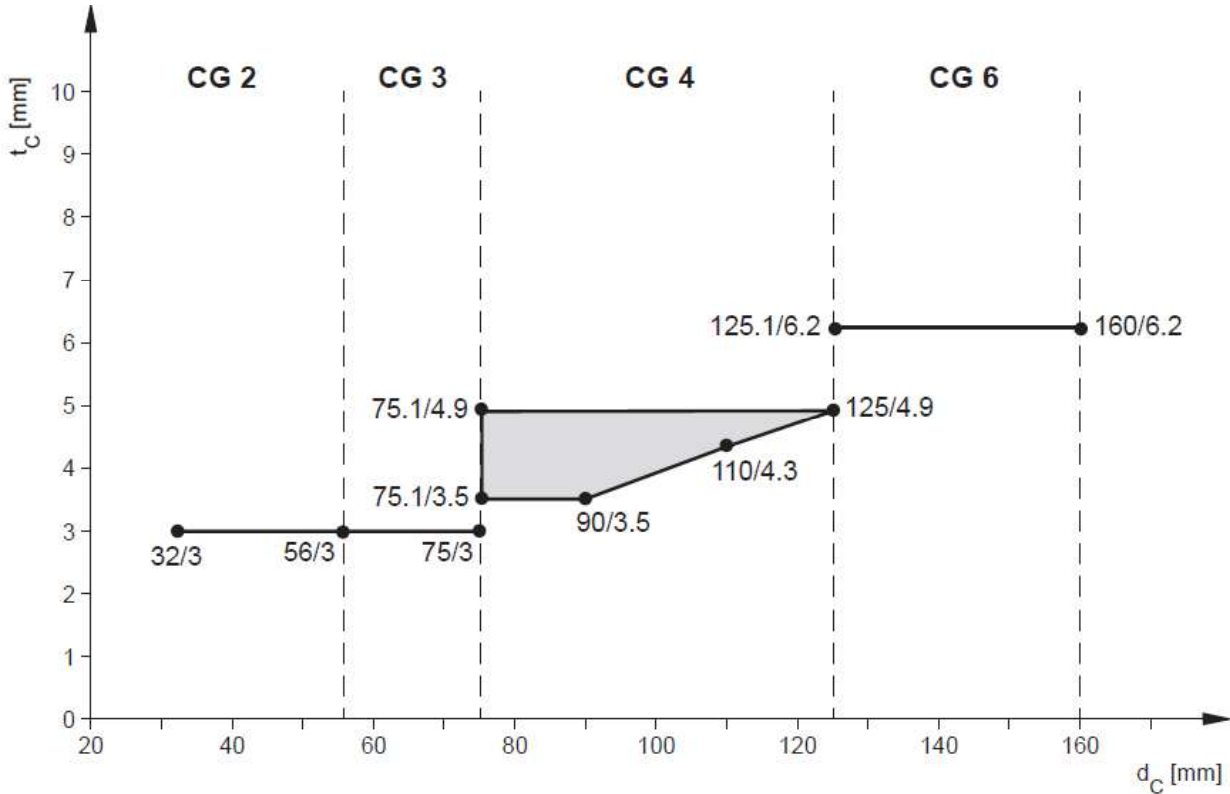

8.4.5.2. PE-S2 pipes, designation "Geberit Silent dB20"

EI 90-U/U, Seal design: i) according to clause 8.4.4

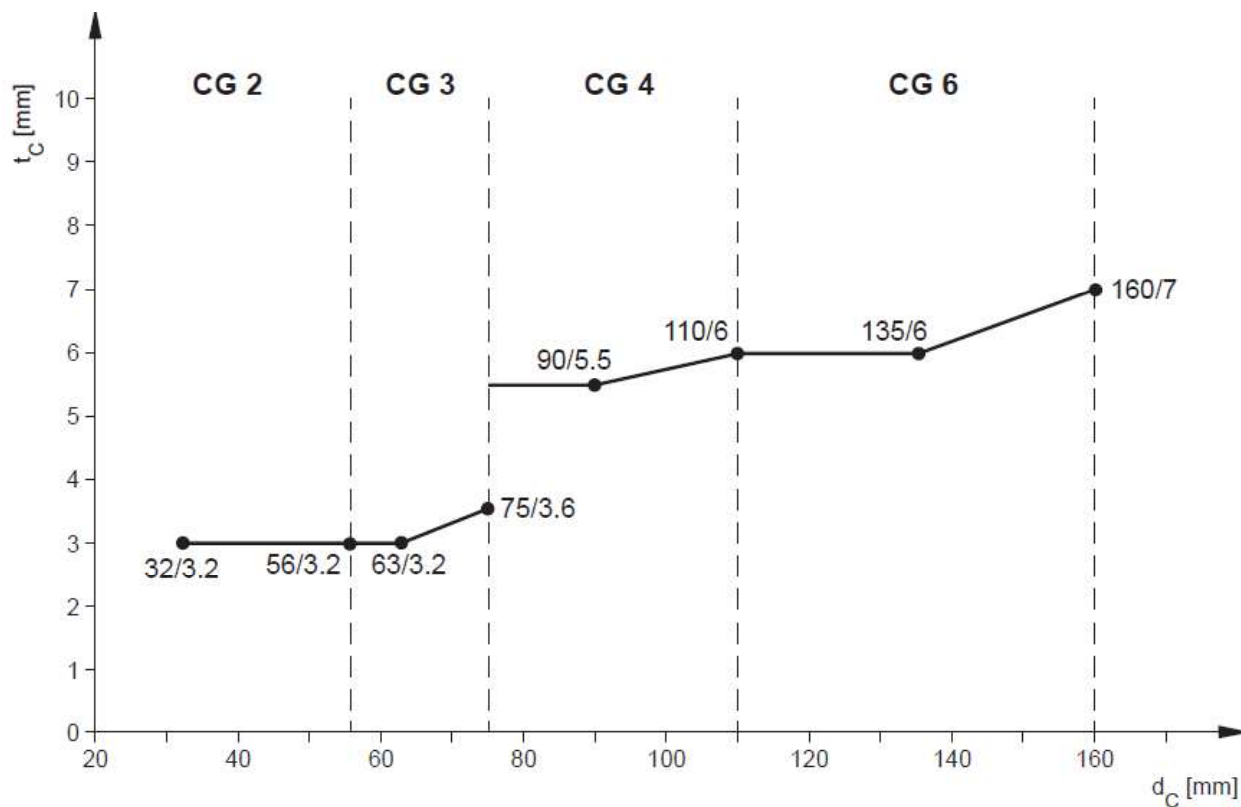

8.4.5.3. Insulated PE pipes according to EN 1519-1, EN 12666-1, EN 12201-2

EI 90- U//U, Seal design: ii) according to clause 8.4.4

Insulation in CS-position

For brands and manufacturers of elastomeric insulation: refer to clause 8.2.10

Pipe wall thickness: for CG 2: 3,0 mm; for CG 4: 3,0 mm; for CG 5: (3,0 – 3,5) mm

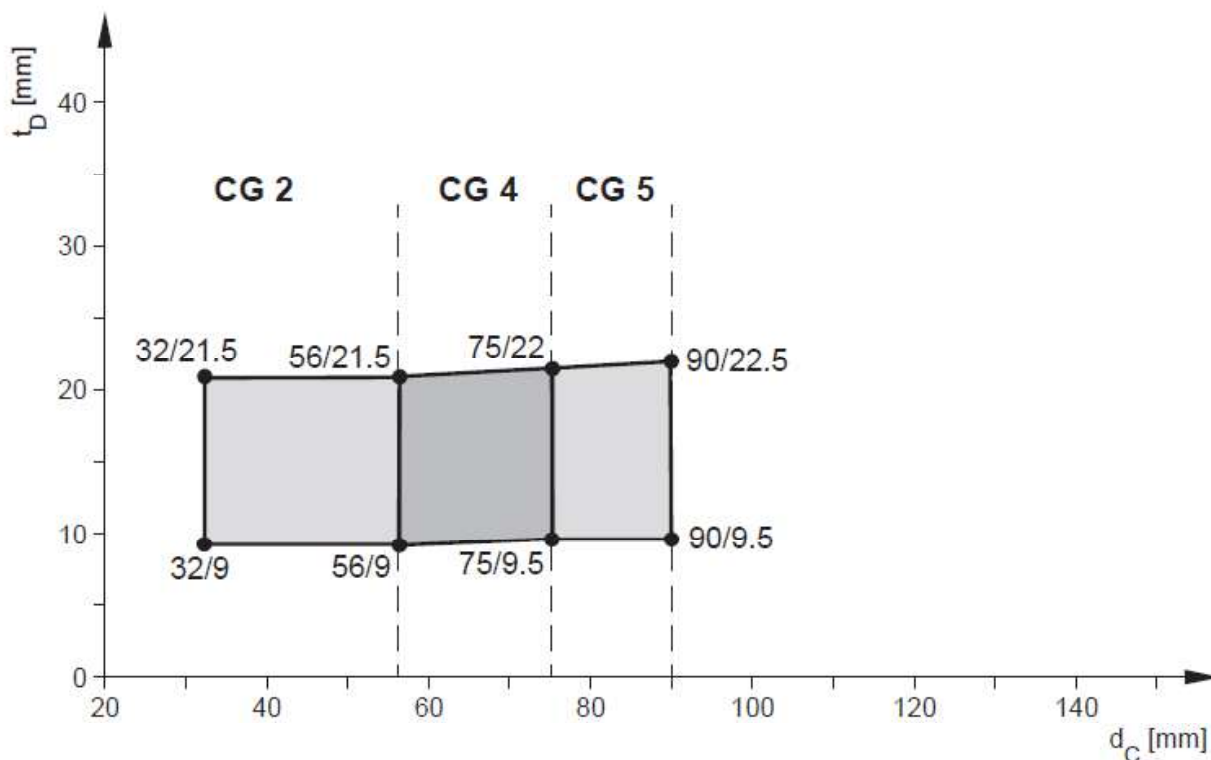

8.4.5.4. PP pipes, non-Regulated

EI 90-U/U, Seal design: i) according to clause 8.4.4

For assessed brands and manufacturers: refer to clause 8.2.11

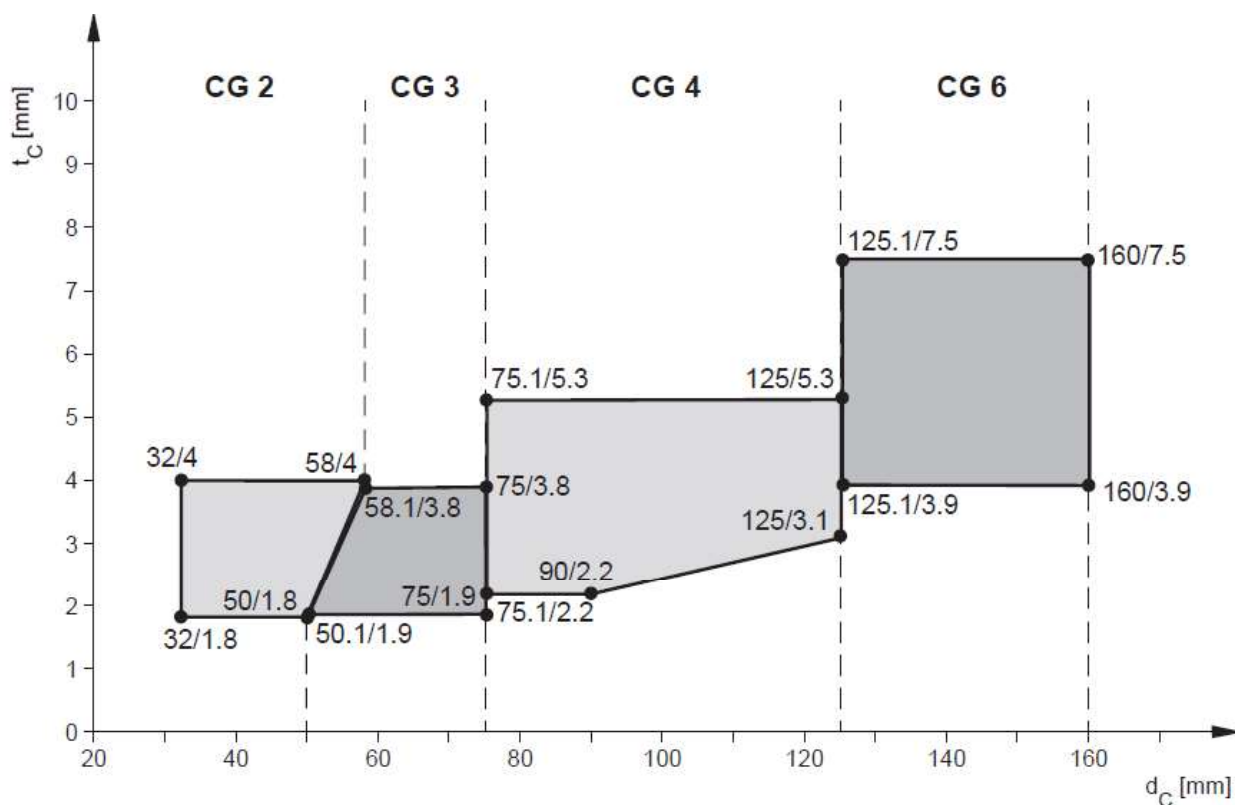

**8.4.5.5. PVC pipes according to EN ISO 1452-1, (covers EN 1329-1, EN 1453-1, EN 1566-1),
 EN ISO 15493 (Industrial, equivalent EN 1452)**

EI 90-U/U, Seal design: i) according to clause 8.4.4

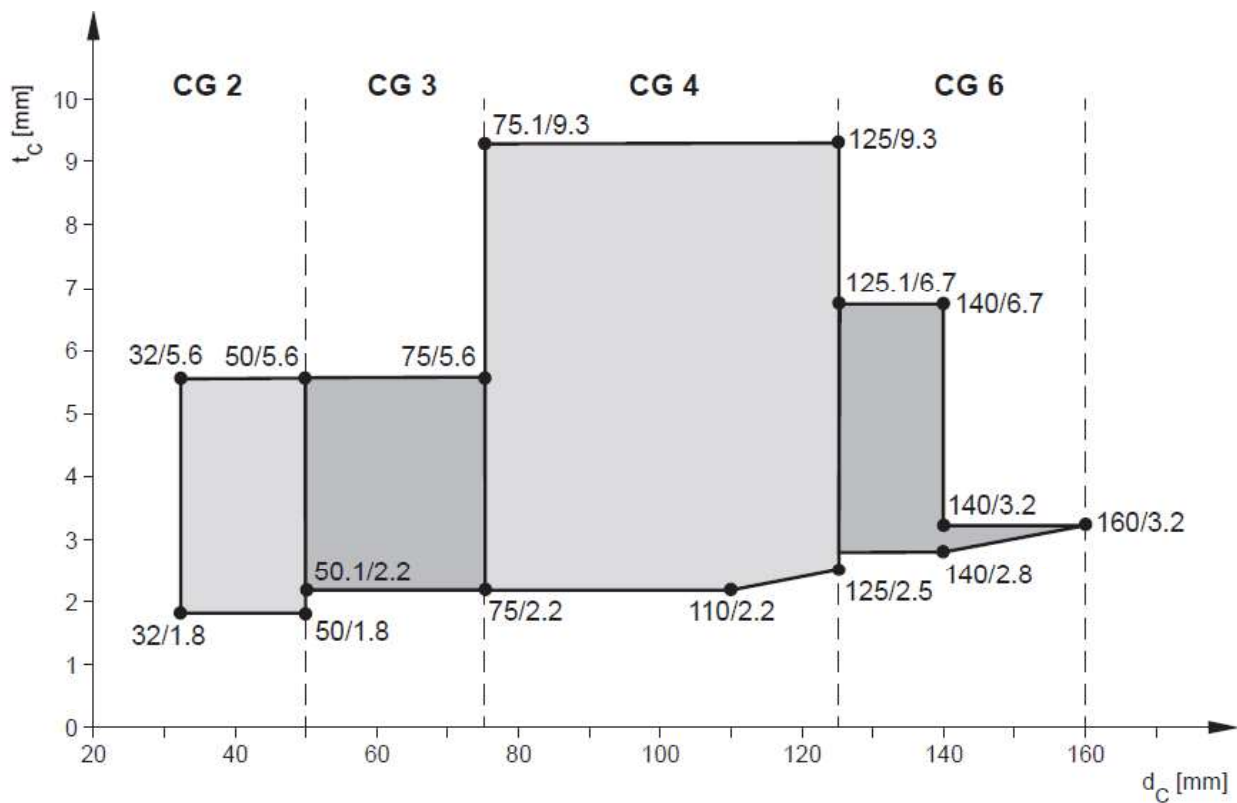

8.4.6. Assessed Application with Hilti Firestop Wrap CFS-W P in rigid floor with reduced number of layers (CG)

8.4.6.1. PE pipes according to EN 1519-1, EN 12666-1, EN 12201-2 (reduced number of layers)

EI 90-U/C, Seal design: iii) according to clause 8.4.4

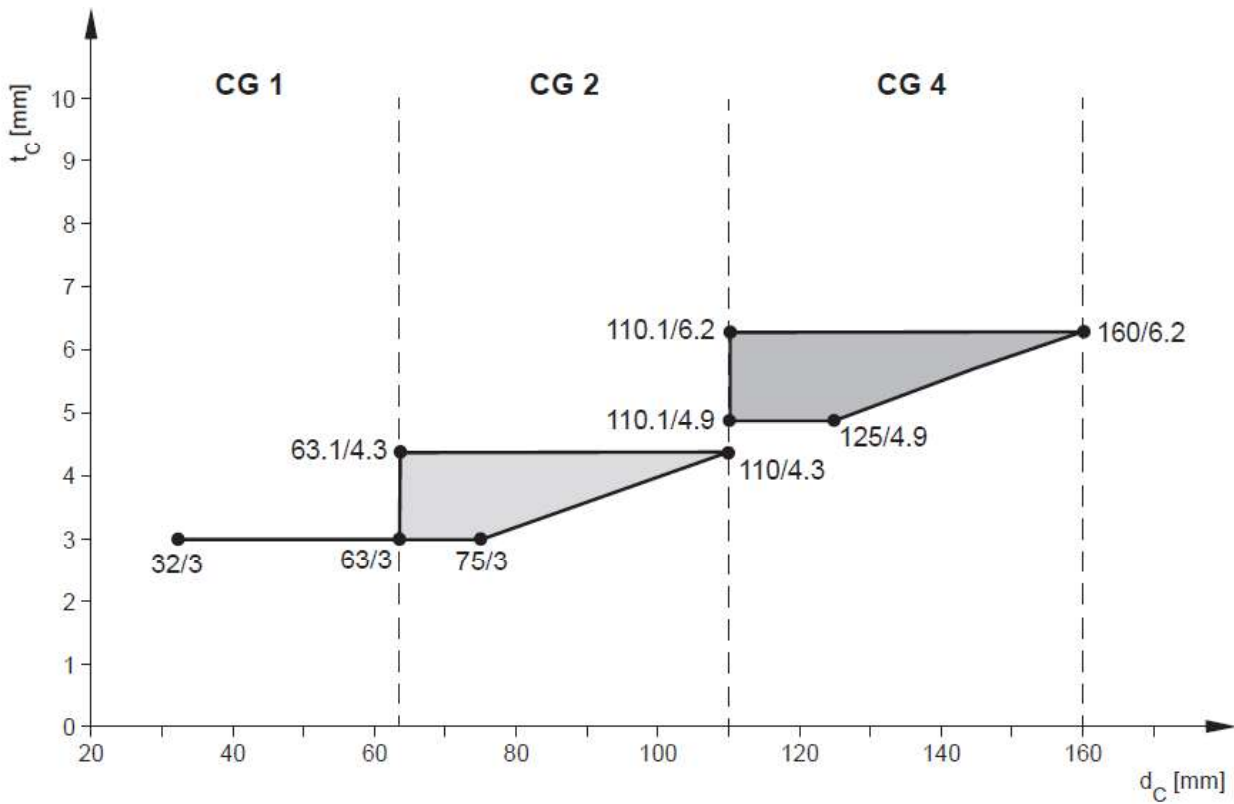

8.4.6.2. PE-S2 pipes, designation “Geberit Silent dB20”, (reduced number of layers)

EI 90-U/C, Seal design: iii) according to clause 8.4.4

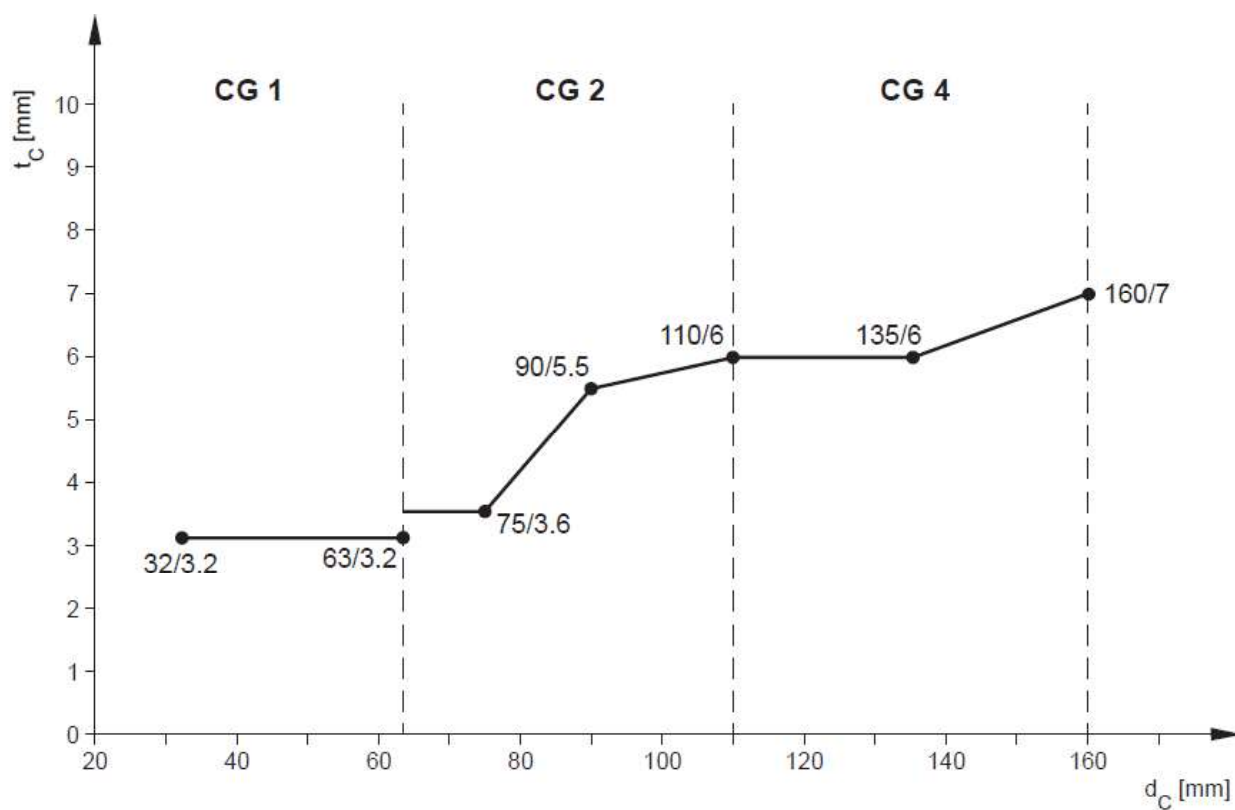

8.4.6.3. PE pipes according to EN 1519-1, EN 12666-1, EN 12201-2, (reduced number of layers)

EI 90-U/C, Seal design: iv) according to clause 8.4.4

Insulation in CS-position, for assessed brands and manufacturers: refer to clause 8.2.10

Pipe wall thickness: for CG 1: 3,0 mm; for CG 2: (3,0 – 3,5) mm

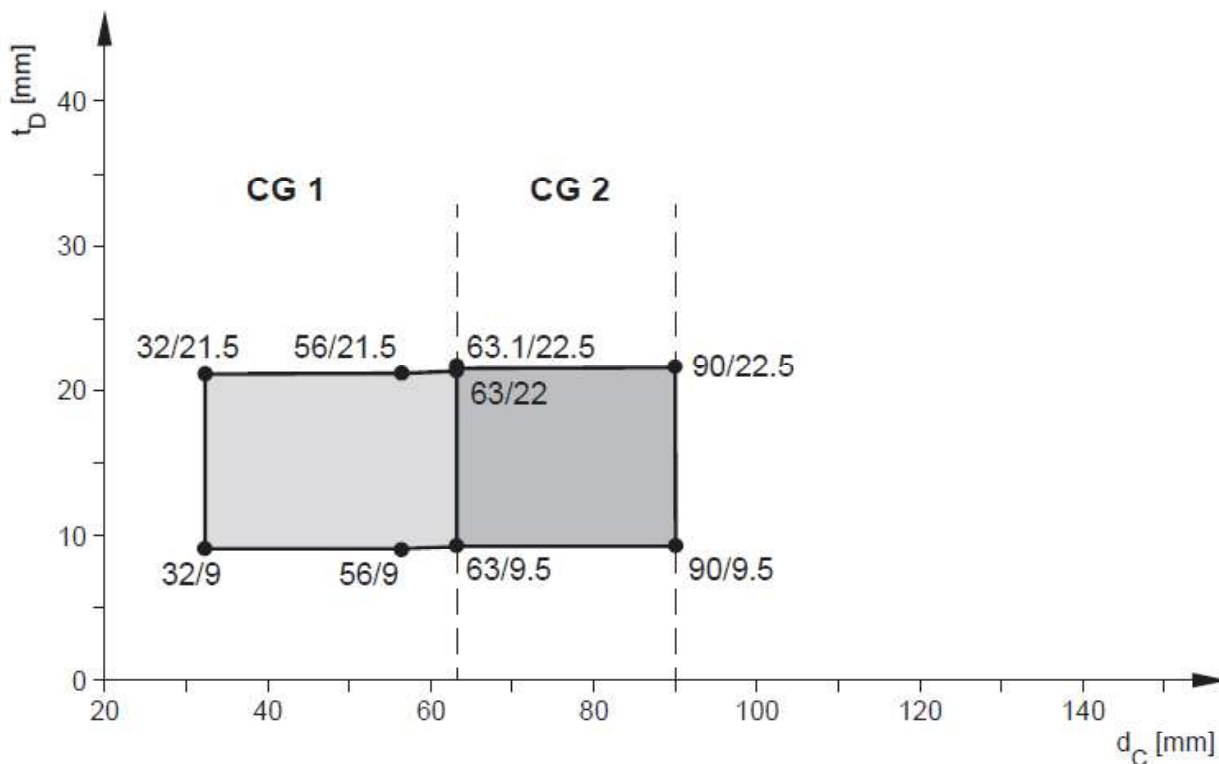

8.4.6.4. PE pipes according EN 15494 (reduced number of layers)

EI 90-U/C, Seal design: iii) according to clause 8.4.4

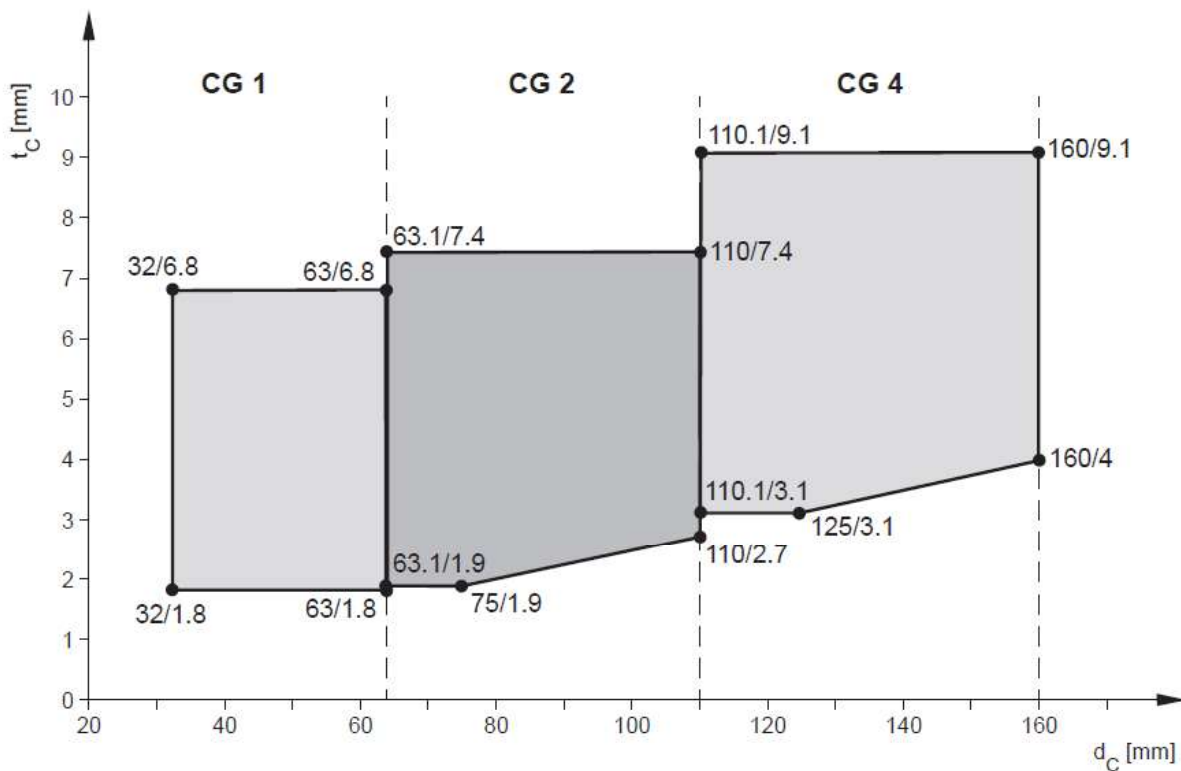

8.4.6.5. PP pipes, non-regulated (reduced number of layers)

EI 90-U/C, Seal design: iii) according to clause 8.4.4
For assessed brands and manufacturers: refer to clause 8.2.11

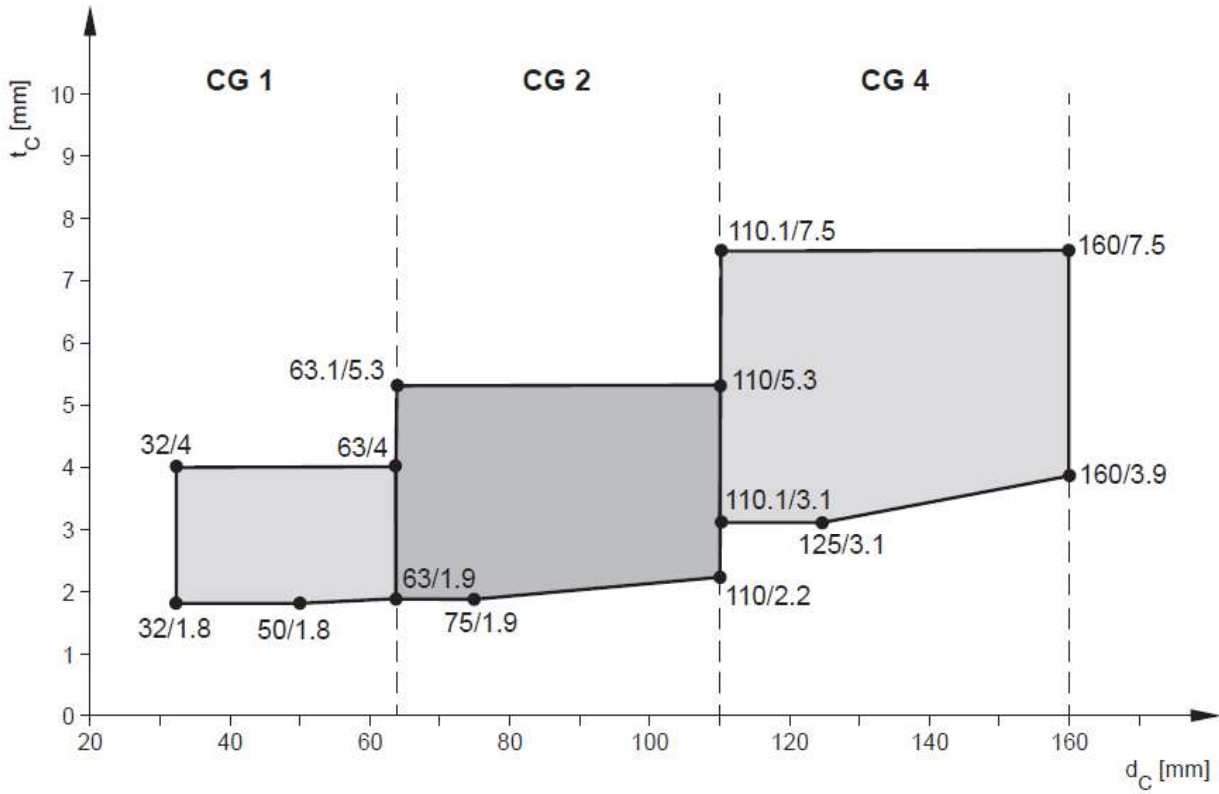

8.4.6.6. PVC pipes according to EN ISO 1452-1, (covers EN 1329-1, EN 1453-1, EN 1566-1), EN ISO 15493 (Industrial, equivalent EN 1452), (reduced number of layers)

EI 90-U/C, Seal design: iii) according to clause 8.4.4

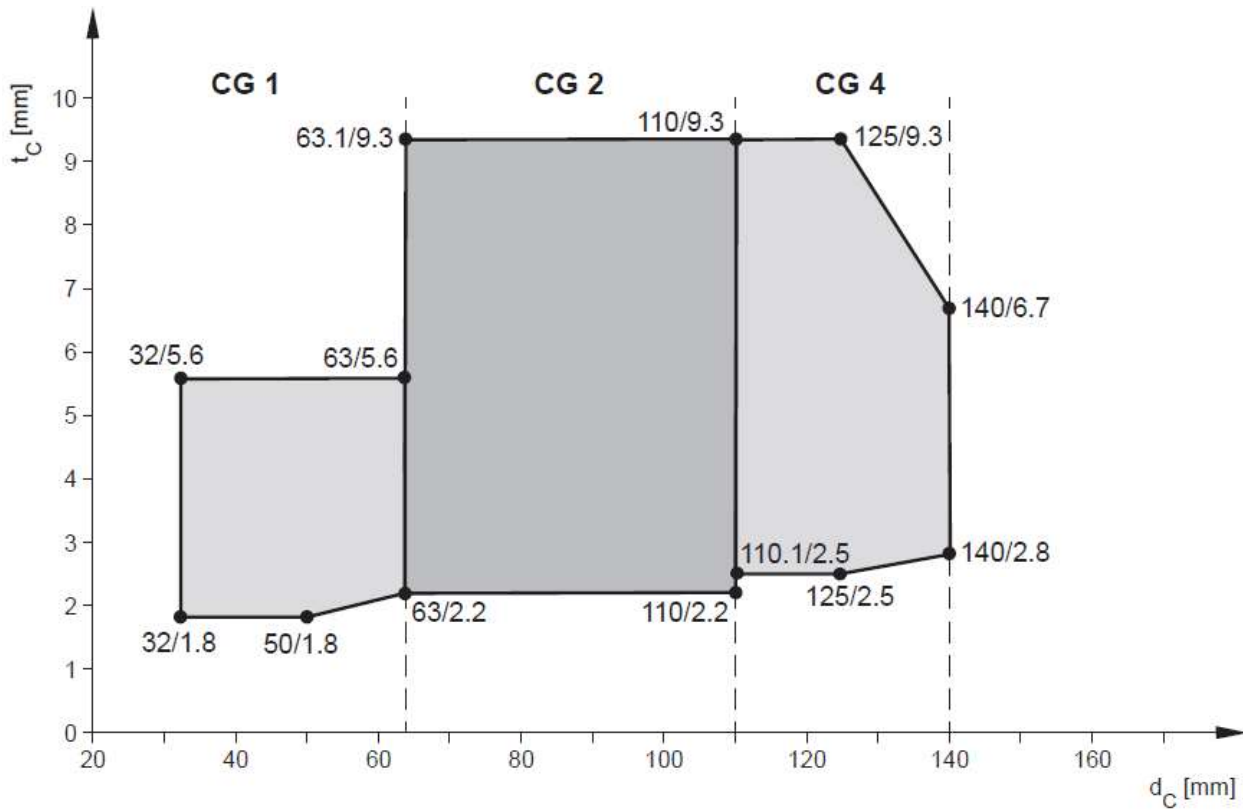

8.5. Shaftwall application

8.5.1. Suitable Shaft wall systems: 3 x 15 mm boards

Hilti Firestop Wrap CFS-W P (A₁) can be used to seal insulated Aluminum composite pipes installed in shaft wall systems classified at least with EI 90 according EN 13501-2. The mechanical resistance and stability have been proven for the required fire resistance period. Maximum wall dimension: 3000 mm high, 1250 mm width. The Shaft Wall should consist of the following components:

Boards:

Minimum three layers each of ≥ 15 mm gypsum boards acc. EN 520, Type DF

Track and Studs:

CW and UW Profil size 50 or bigger (acc. EN 14195),

Profiles should be minimum a 50 mm x 50 mm x 0,6 mm thick galvanized preformed steel sheet.

Fixing/Screws:

First layer should be fixed using 25 mm long x 3,5 mm diameter flexible wall screws, second layer should be fixed with 45 mm long x 3,5 mm diameter flexible wall screws, third layer should be fixed using 55 mm long x 3,5 mm diameter flexible wall screws

Gypsum:

Gypsum - based plaster.

8.5.2. Penetrating pipes

- For shaft wall system B: 3 x 15 mm (refer to clause 8.5.1)
- Same installation for double or single side fire access
- Polyethylene insulated or pre-insulated Aluminum Composite pipes only (and Rehau Rautitan Flex – PE-X) – see table below
- single penetration seal and multiple penetration seal assessed
- Pipe end configuration: U/C
- For type and thickness of PE-insulation refer to clause 8.5.8
- An additional protection insulation for material type and thickness refer to clause 8.5.9
- Hilti Firestop Wrap CFS-W P (A₁) inside the shaft wall, in a central position
- For pipe brand / specification see table below

Aluminum composite pipe brand/name	Assessed pipe diameter (mm)	Assessed pipe wall thickness (mm)	Assessed PE-Insulation thickness (mm)
Kelox Ke Kelit	16 – 32	2,0 – 3,0	4 – 13
Uponor Unipipe Plus	16 – 32	2,0 – 3,0	4 – 10 (13)*
TECE TECEflex	16 – 32	2,75 – 4,0	4 – 13
Geberit Mepla	20	2,5	6 – 13
Geberit Mepla	32	3,0	4 – 13
Rehau Rautitan Stabil	16,2 – 32	2,6 – 4,7	4 – 13
Rehau Rautitan Flex	16 – 32	2,2 – 4,4	4 – 13

* max.13 mm PE insulation for Uponor 32 x 3,0 mm, all other Uponor pipes: max.10 mm

8.5.3. Annular Gap

For shaft walls (refer to clause 8.5.1) annular gap size around single penetrating aluminum composite pipes and multiple pipe seals using CFS-W P to seal side edge (basement E) is always ($0 \leq s_3 \leq 15$) mm.

8.5.4. Gap Filler in Shaft Walls

CFS-S ACR must be installed over the entire wall thickness. No backfilling has to be used.

8.5.5. Firestop installation and wrap fixing

Hilti Firestop Wrap CFS-W P installation can be done from one side of the wall only. The product should be wrapped around the single penetration / multiple penetration prior the installation of CFS-S ACR with an overlapping of appr. 10 mm. The necessary number of layers must be considered (Construction Group = CG = number of layers). The wrapped product is secured by means of 30 – 50 mm adhesive strip (non-specified). The seal should be moved into the wall opening into a central position. There should be no gap between the CFS-W P wrap and the pipe insulation for single penetration.

8.5.6. Pipe support

Pipes shall be supported at maximum 250 mm away from both faces of wall constructions system A and B. (first support)

8.5.7. Pipe orientation

All pipes must penetrate the shaft wall in a perpendicular orientation only.

8.5.8. PE pipe insulation

PE- foam Insulation has to be in CS-situation on the Aluminum Composite pipes.

- For aluminum composite pipe brand refer to clause 8.5.2
- For aluminum composite pipe dimension refer to clause 8.5.2
- For assessed PE-foam thickness refer to clause 8.5.2

8.5.9. Additional Protection Insulation

An additional protection insulation DP has to be used on every pipe, penetrating the shaftwall. DP has to be installed on top of the pipe insulation D.

Installation situation:

- LI (local interrupted, do not penetrate the wall),
- Length $L_{DP} \geq 250$ mm on each side,
- Additional Protection insulation thickness: $t_{DP} \geq 9,0$ mm
- For material type/brand refer to clause 8.2.10

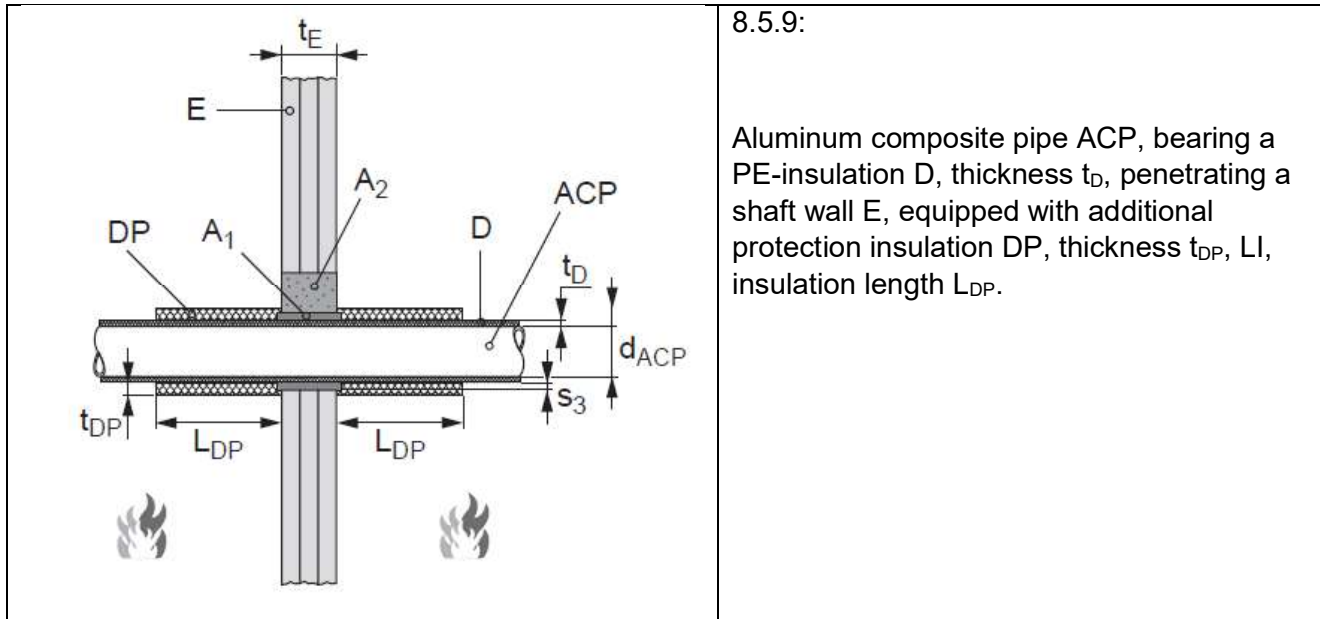

8.5.10. Zero distance pipe to pipe

Penetrating Aluminum Composite Pipes (ACP) may penetrate the shaft wall as a multiple seal in a parallel installation.

- For Pipe brand/type refer to clause 8.5.2
- All pipes in U/C end configuration
- All pipes bearing the insulation D (refer to clause 8.5.8) and additional protection insulation DP (refer to clause 8.5.9)
- Distance $s_2 \geq 0$ mm between adjacent pipe, DP to DP
- Distance between pipe insulation D and edge of seal (E) is $(0 \leq s_3 \leq 15)$ mm
- Only linear arrangement allowed, no cluster
- Number of pipes in line: unlimited
- Linear arrangement in horizontal or vertical position assessed

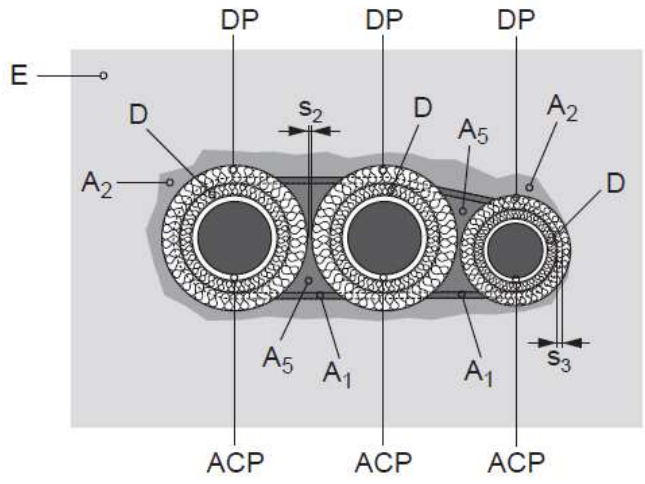
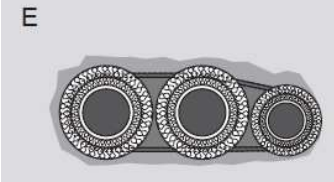
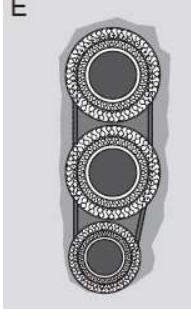
	<p>8.5.10.A:</p> <p>Three isolated (D) aluminum composite pipes (ACP), bearing a protection insulation DP. Zero distance s_2 (DP to DP) possible. Zero distance s_3 pipe insulation D to side edge of seal (basement E) is allowed.</p>
	<p>8.5.10.B:</p> <p>Linear arrangement of isolated aluminum composite pipes in horizontal position</p>
	<p>8.5.10.C:</p> <p>Linear arrangement of isolated aluminum composite pipes in vertical position</p>

9 ANNEX D - ABBREVIATIONS USED IN DRAWINGS

Abbreviation	Description
A ₁	Hilti Firestop Wrap CFS-W P
A ₁₀	Hilti Firestop Collar Endless CFS-C EL with oddment
A ₂	Annular gap seal with Hilti Firestop Acrylic Sealant CFS-S ACR
A ₃	Annular gap seal with gypsum / plaster
A ₄	Annular gap seal with mortar
A ₅	Annular gap seal with Hilti CFS-FIL
ACP	Aluminum Composite Pipe
B	Backfilling material (mineral wool)
C	Plastic Pipe
C ₁	Sound decoupling insulation / Acoustic pipe insulation
CG	Construction Group of CFS-W P
D	Pipe insulation
D _W	Pipe insulation, incombustible, based on mineral wool
D _E	Pipe insulation, combustibile, based on elastomeric foamed material
DP	Pipe insulation - Protection insulation
D _{PE}	Pipe insulation, combustibile, based on polyethylene foam
d _C	Pipe diameter (nominal outside diameter) for plastic pipes
d _M	Pipe diameter (nominal outside diameter) for metal pipes
d _{ACP}	Pipe diameter (nominal outside diameter) for Aluminum composite pipes
d _{RC}	Pipe diameter (nominal outside diameter) for Cable conduits
E	Building element (wall, floor)
F	Metallic Z-Profiles
L _D	Length of Insulation
L _{DP}	Length of Protection Insulation
L _{RC}	Projecting Length for electric conduits, filled or unfilled
n	amount, number of pieces
M	Metal pipe
PG	Pipe group
R	Electric Cables, optical cables
RC	Conduit for electric/optical cables
RB	Bundle of electric/optical cables
RS	Cable support system
S ₁	Minimum distance between single penetration seals
S ₂	Minimum distance between clustered pipe or other penetrants within one penetration
S ₃	Minimum distance between penetrating pipe and building element

10 ANNEX E - INSTALLATION OF THE PRODUCT AND ANCILLARY PRODUCT(S)

The arrangement and installation of Hilti Firestop Wrap CFS-W P shall be done in accordance with the details given below and in Annex C for the penetration seal(s).

Rigid/Flexible Wall Application:

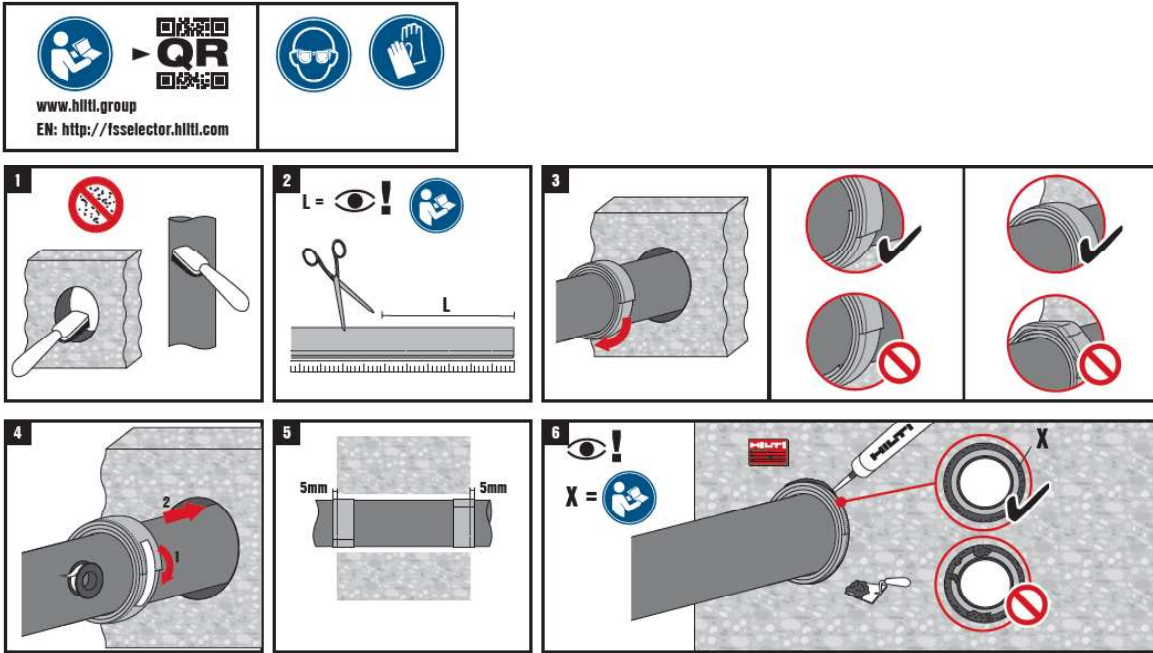

Rigid Floor Application:

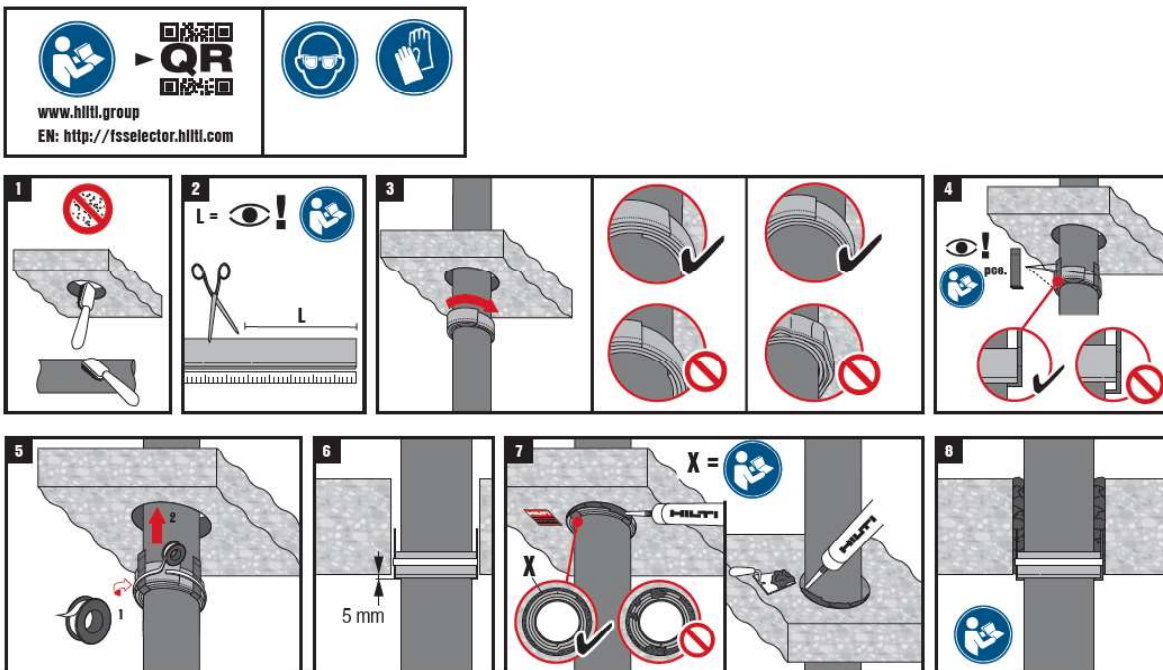

Wall Application in Coated Board:

For the wall application of "Hilti Firestop Wrap CFS-W P" in coated boards refer to ETA-11/0429.

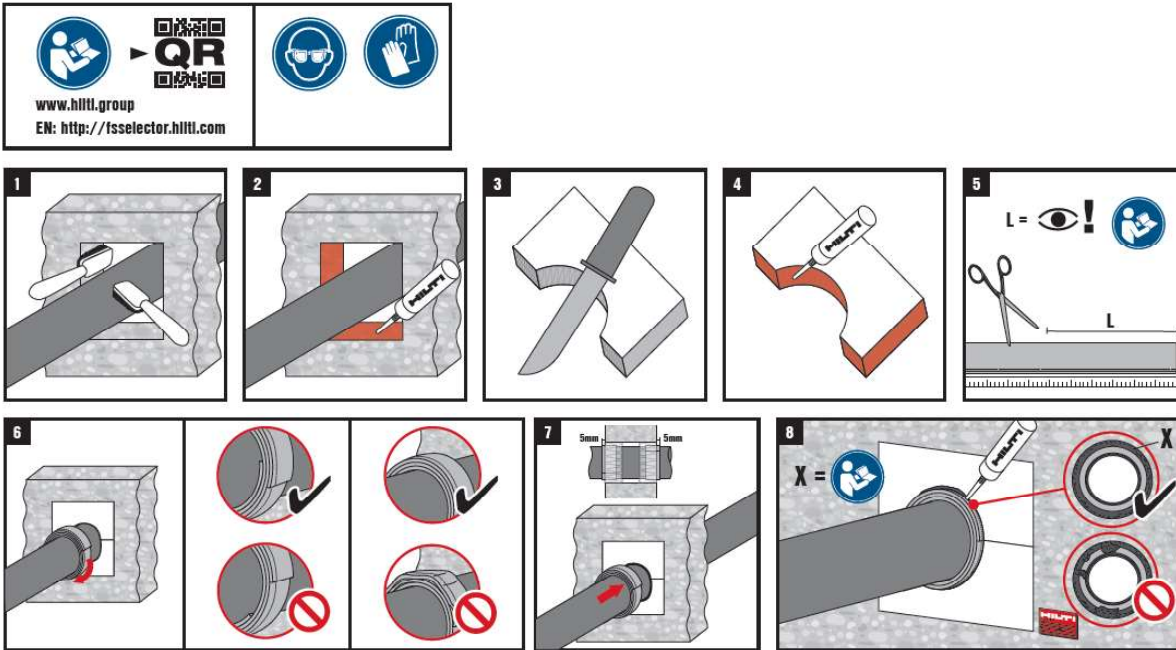

Floor Application in Coated Board:

For the floor application of "Hilti Firestop Wrap CFS-W P" in coated boards refer to ETA-11/0429.

