



## **MFT-FOX VTR-1L-HIDDEN CLAMPS**

Aluminum/Stainless steel support system  
for rainscreen cladding

Hilti facade system





## **MFT-FOX VTR-1L**

The system consists of stainless steel wall brackets and aluminum profiles and is specifically designed for vertical substructures in ventilated facades. Wall brackets are supplied with an additional isolator pad and different hole geometries in the base plate which allow the usage of every standard Hilti anchor.

Wall brackets are designed with fix or flexible points to allow for thermal expansion of the profile. The fixed point takes the weight of the panels and substructure and the proportional wind loads, while the flexible point only assumes the proportional wind loads.

Vertical profiles are connected to the wall brackets with specially designed screws for fixed and flexible points. This allows virtually frictionless sliding of the profiles against the wall brackets and keeps the profile connected by the fixed point in place. The flexible point makes sure that there are no additional loads on the substructure by the profile's expansion forces.

With this system, wall tolerances of up to 40 mm can be perfectly compensated. The wall brackets are available from 60 mm to 300 mm in 20 mm increments, each in two different sizes (large and medium). The isolator pad separates the substructure from the base material to reduce thermal bridging.

### **Advantages:**

- Flexible design using fixed and flexible points
- Two different sizes of brackets (large and medium)
- Bracket length 60 – 300 mm
- Stainless Steel A4 material
- Lower heat loss of bracket due to additional cut outs
- 40 mm adjustment capability of the profiles in the wall brackets
- Brackets can be mounted with every standard Hilti anchor / fastening method
- The isolator separates the substructure from the base material to reduce thermal bridging
- Substructures can be designed with PROFIS Façade to generate technically-sound and economically-optimised solutions
- Can be used with all common cladding materials

## View of cladding

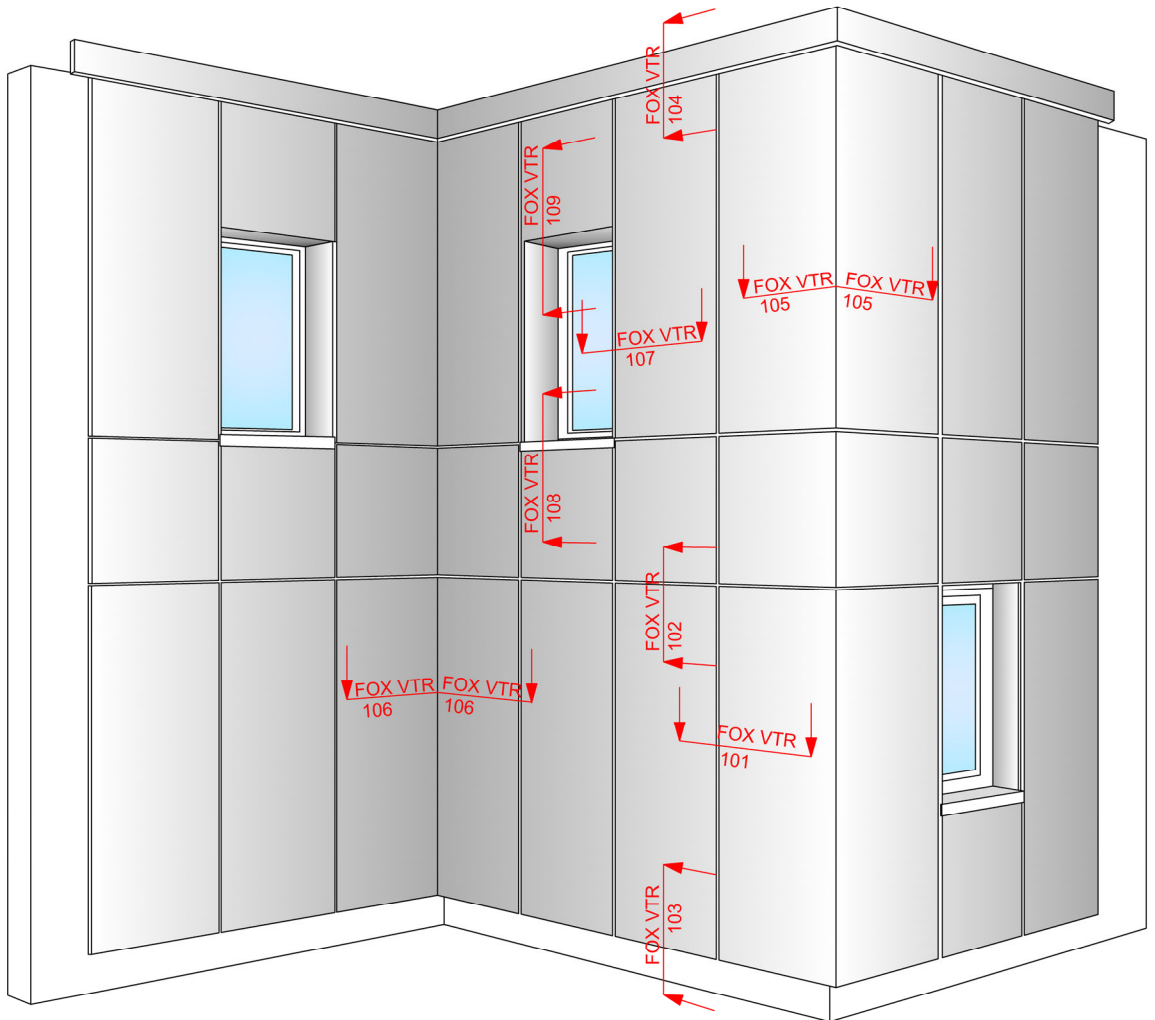

### CONTENTS:

MFT FOX VTR	101	Horizontal section
MFT FOX VTR	102	Vertical section
MFT FOX VTR	103	Bottom detail
MFT FOX VTR	104	Top detail
MFT FOX VTR	105	Outside corner
MFT FOX VTR	106	Inside corner
MFT FOX VTR	107	Window - reveal
MFT FOX VTR	108	Window - sill
MFT FOX VTR	109	Window - lintel



**MFT-FOX VTR-Large**

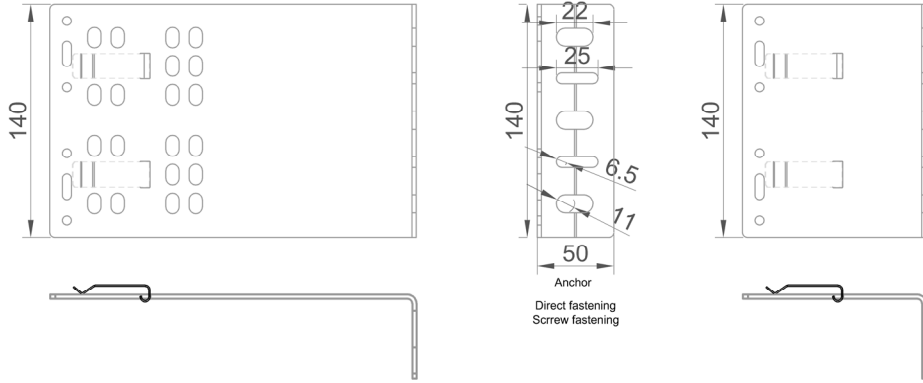

**MFT-FOX VTR-Medium**

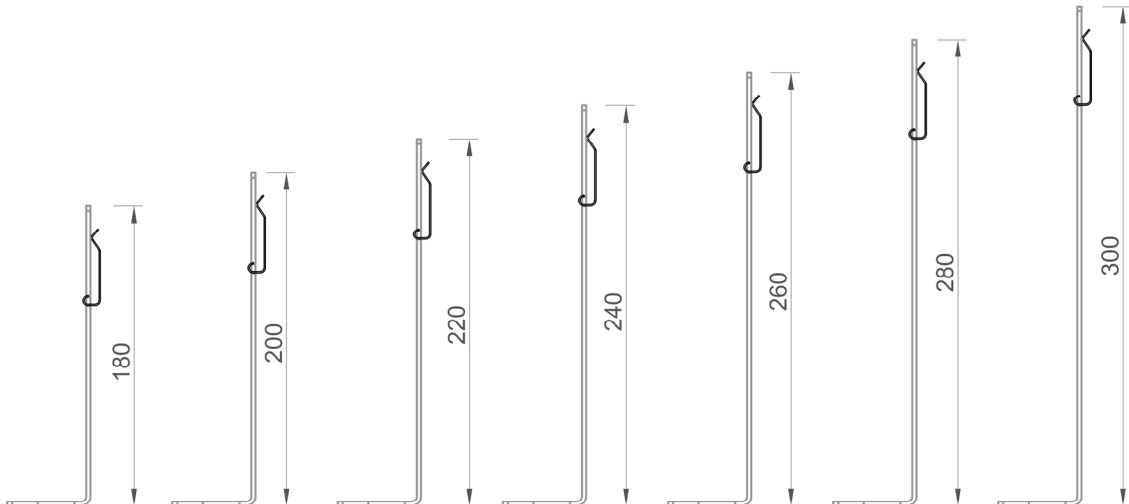
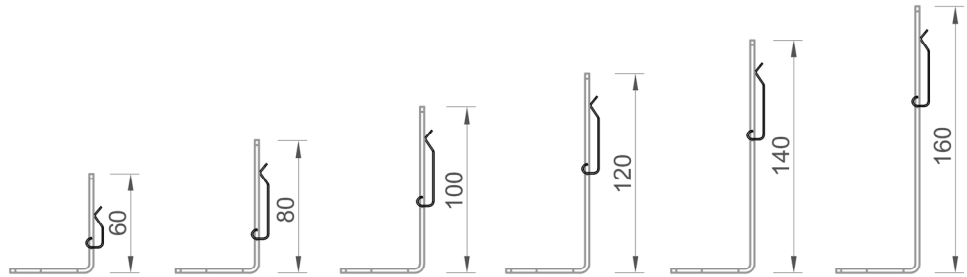
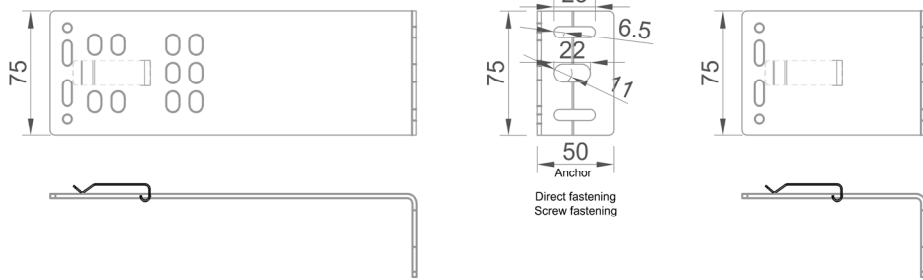



## MFT FOX VTR 101 - Horizontal section

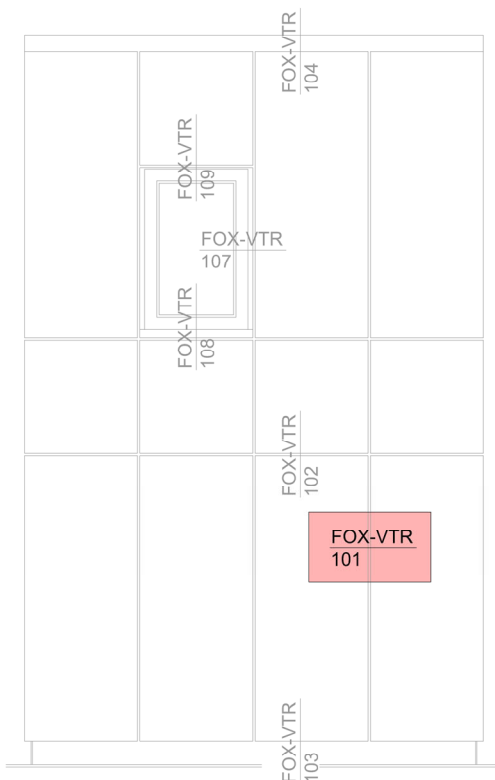
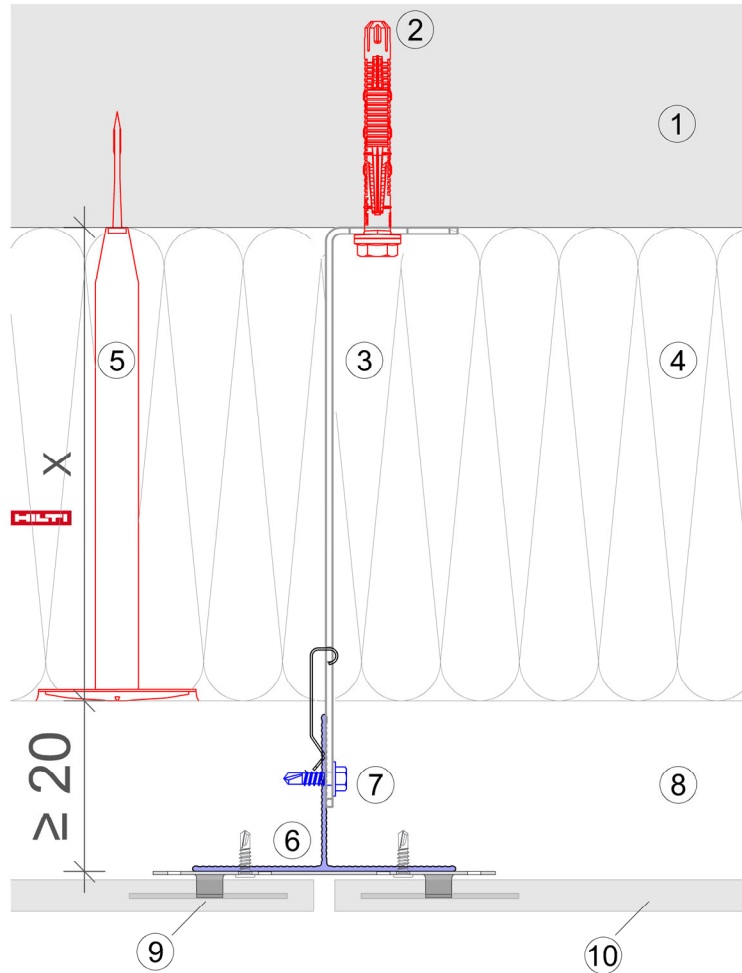

## Legend

- 1 Base material
- 2 Anchor acc. to static
- 3 Bracket + isolator
- 4 Insulation
- 5 Fixing insulation
- 6 Profile
- 7 Self drilling screw
- 8 Ventilation gap
- 9 Hidden clamp
- 10 Cladding



## MFT FOX VTR 102 - Vertical section

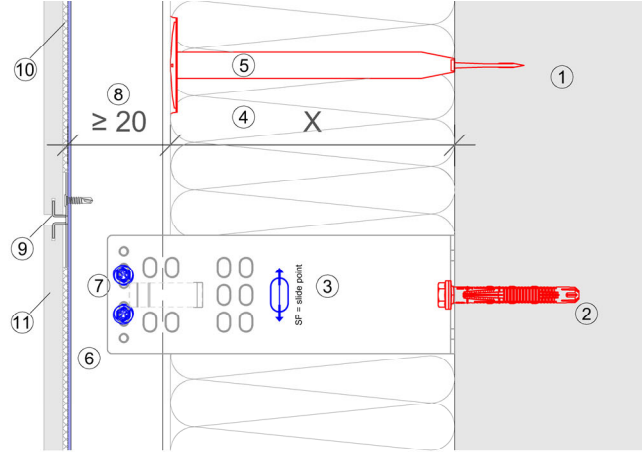

Vertical section-fixed point

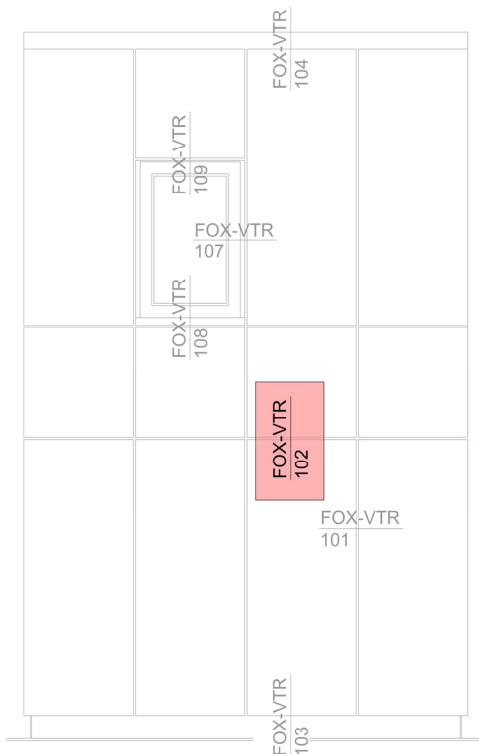
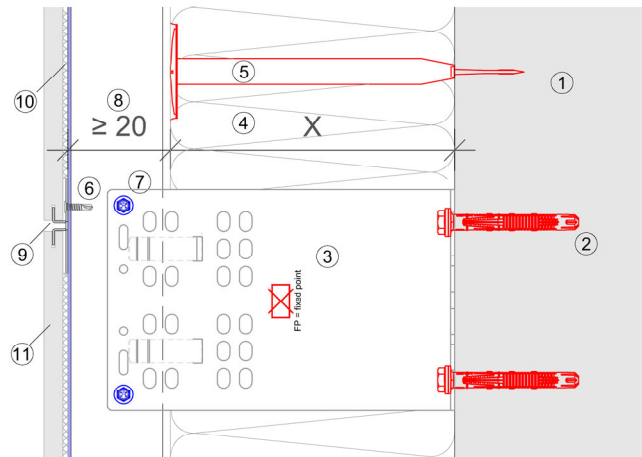

## Legend

- 1 Base material
- 2 Anchor acc. to static
- 3 Bracket + isolator
- 4 Insulation
- 5 Fixing insulation
- 6 Profile
- 7 Self drilling screw
- 8 Ventilation gap
- 9 Hidden clamp
- 10 Adhesive
- 11 Cladding



## MFT FOX VTR 103 - Bottom detail

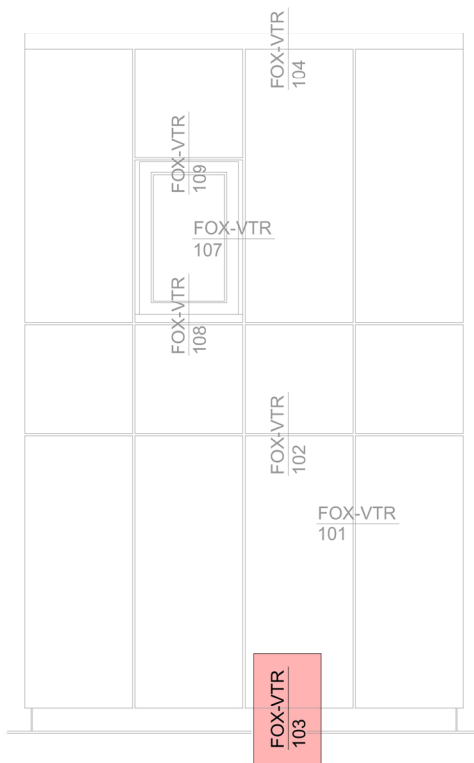
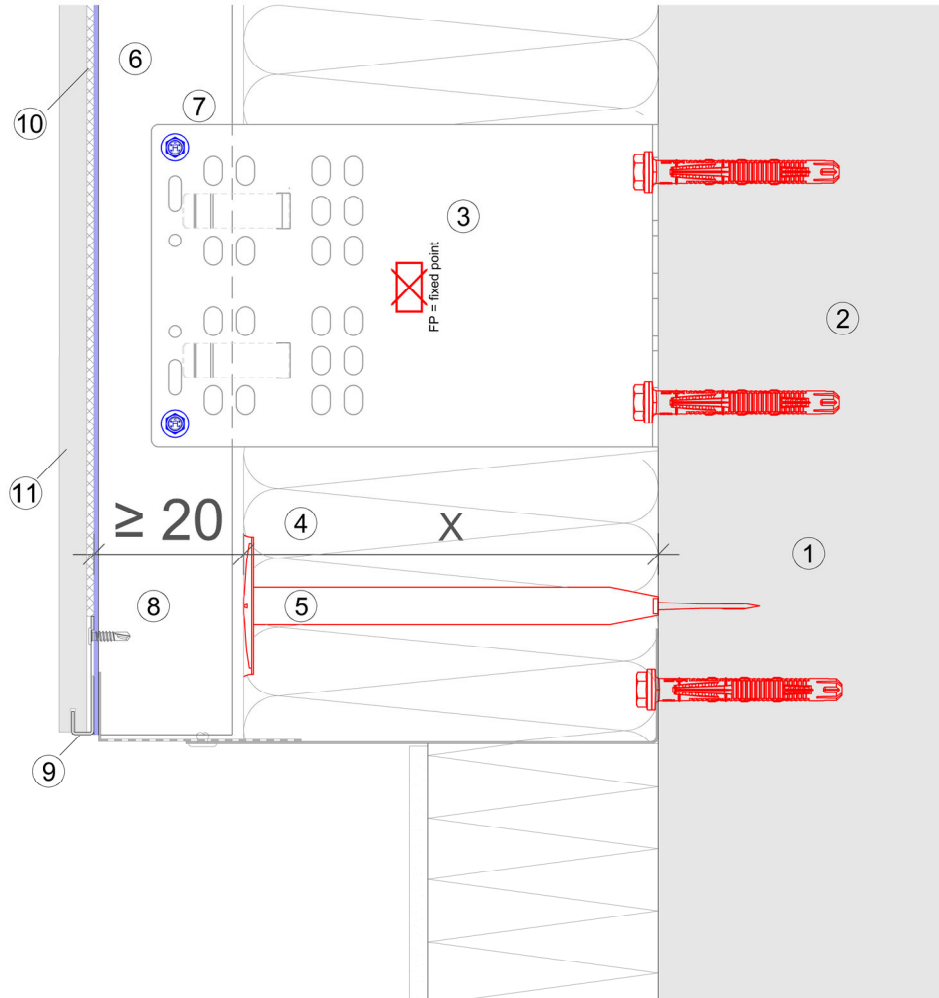

### Legend

- 1 Base material
- 2 Anchor acc. to static
- 3 Bracket + isolator
- 4 Insulation
- 5 Fixing insulation
- 6 Profile
- 7 Self drilling screw
- 8 Ventilation gap
- 9 Hidden clamp
- 10 Adhesive
- 11 Cladding





## MFT FOX VTR 104 - Top detail

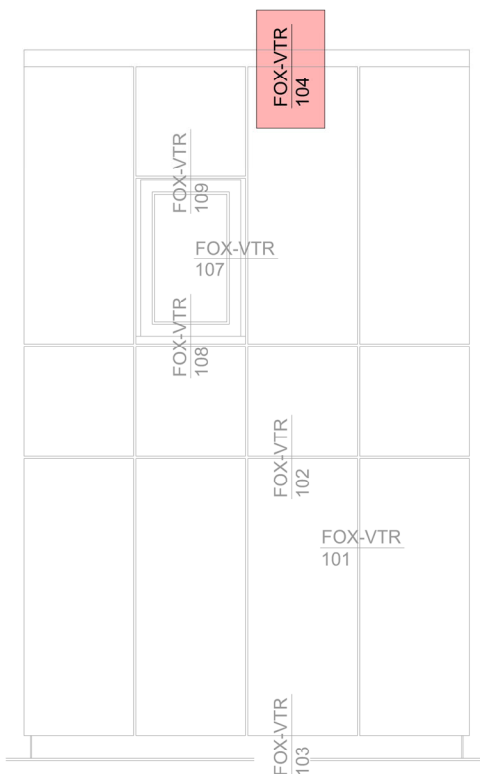
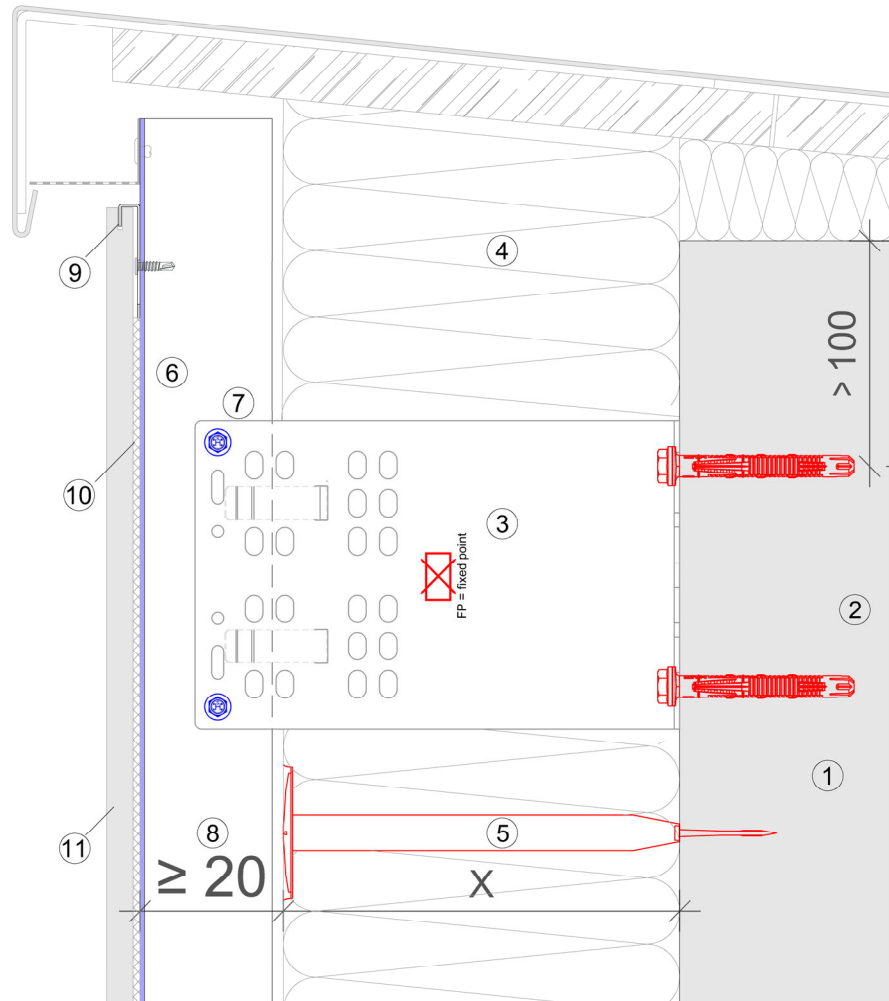

### Legend

- 1 Base material
- 2 Anchor acc. to static
- 3 Bracket + isolator
- 4 Insulation
- 5 Fixing insulation
- 6 Profile
- 7 Self drilling screw
- 8 Ventilation gap
- 9 Hidden clamp
- 10 Adhesive
- 11 Cladding



## MFT FOX VTR 105 - Outside corner

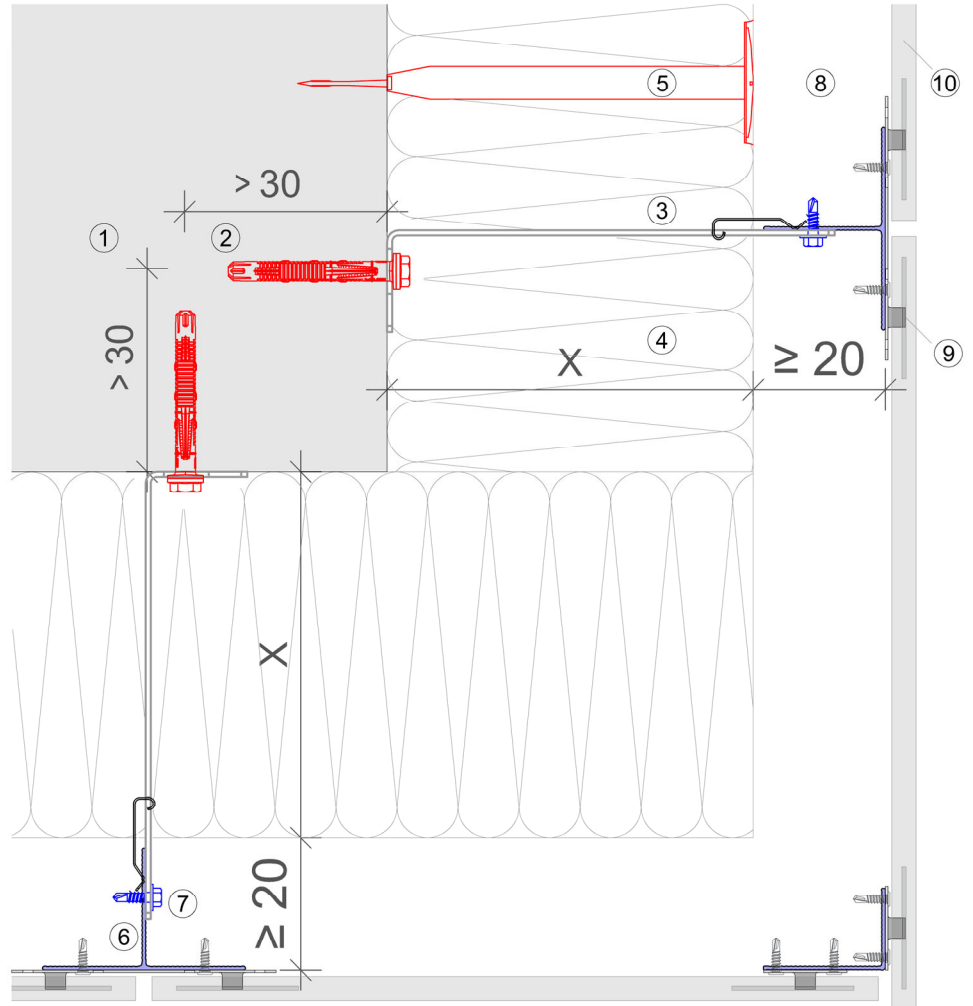

## Legend

- 1 Base material
- 2 Anchor acc. to static
- 3 Bracket + isolator
- 4 Insulation
- 5 Fixing insulation
- 6 Profile
- 7 Self drilling screw
- 8 Ventilation gap
- 9 Hidden clamp
- 10 Cladding



## MFT FOX VTR 106 - Inside corner

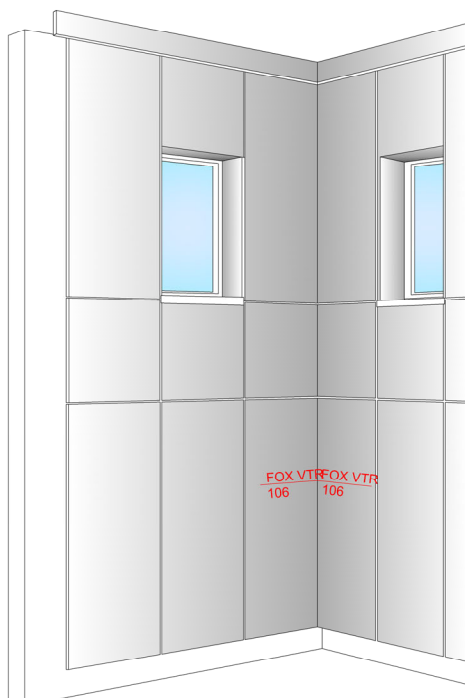
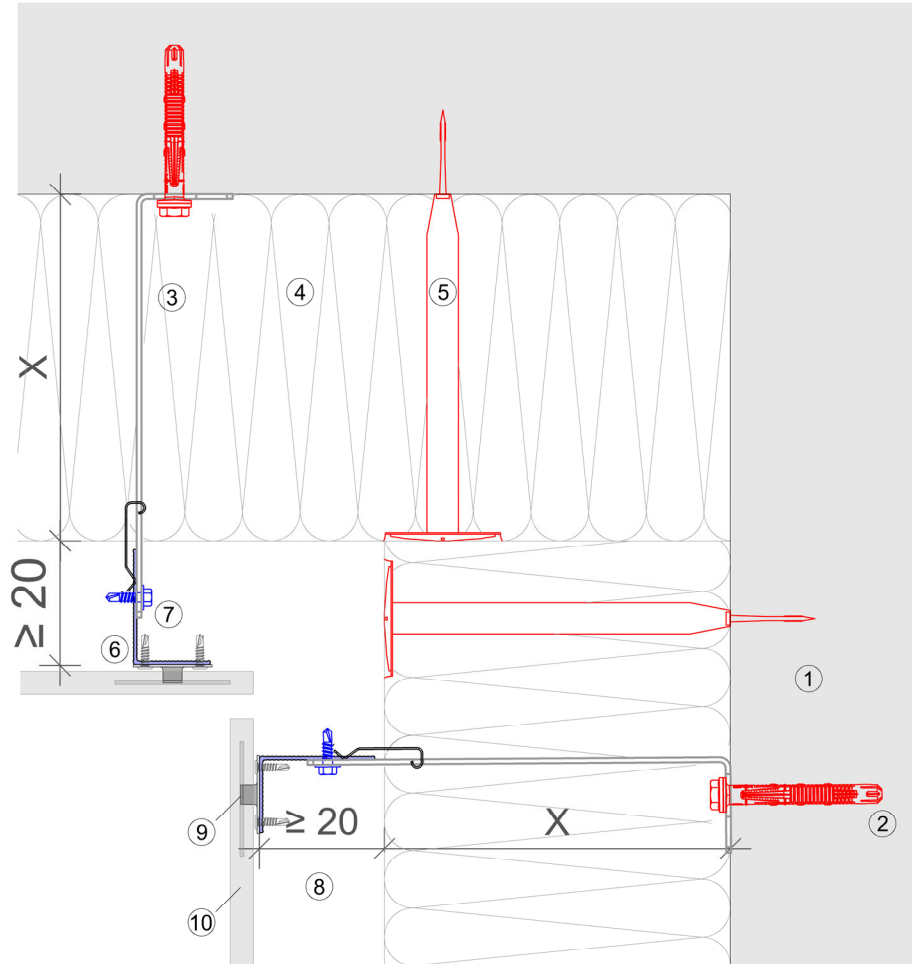

## Legend

- 1 Base material
- 2 Anchor acc. to static
- 3 Bracket + isolator
- 4 Insulation
- 5 Fixing insulation
- 6 Profile
- 7 Self drilling screw
- 8 Ventilation gap
- 9 Hidden clamp
- 10 Cladding



## MFT FOX VTR 107 - Window - reveal

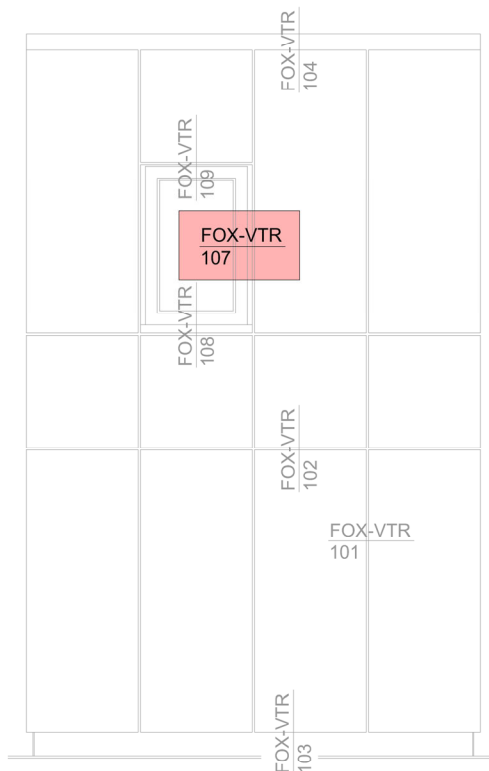
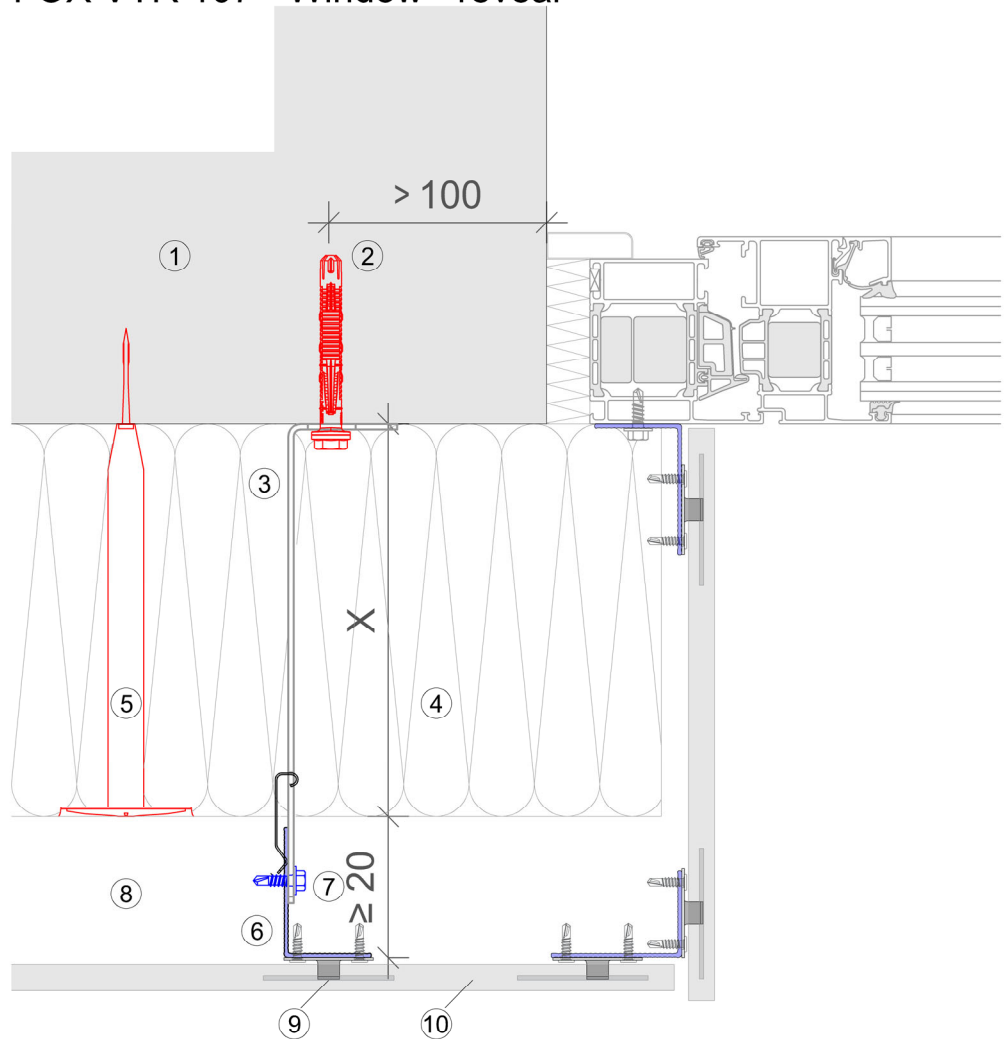

## Legend

- 1 Base material
- 2 Anchor acc. to static
- 3 Bracket + isolator
- 4 Insulation
- 5 Fixing insulation
- 6 Profile
- 7 Self drilling screw
- 8 Ventilation gap
- 9 Hidden clamp
- 10 Cladding



## MFT FOX VTR 107 - Window - reveal

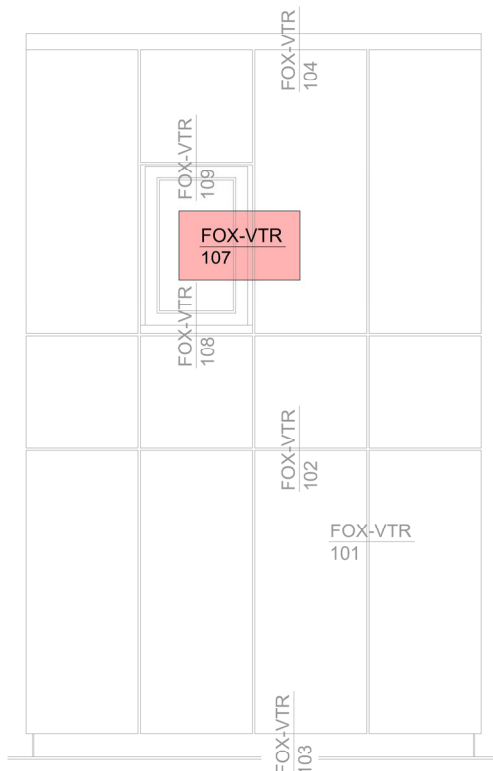
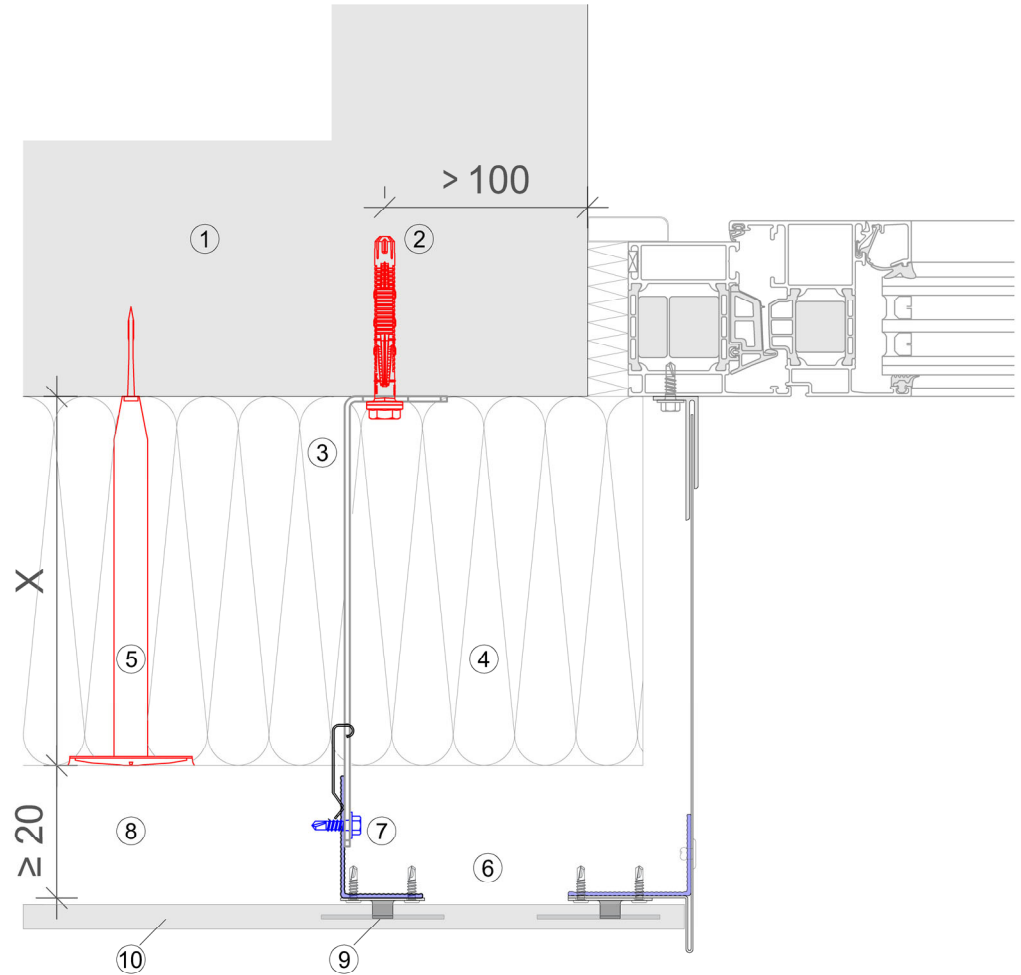

## Legend

- 1 Base material
- 2 Anchor acc. to static
- 3 Bracket + isolator
- 4 Insulation
- 5 Fixing insulation
- 6 Profile
- 7 Self drilling screw
- 8 Ventilation gap
- 9 Hidden clamp
- 10 Cladding



## MFT FOX VTR 108 - Window - sill

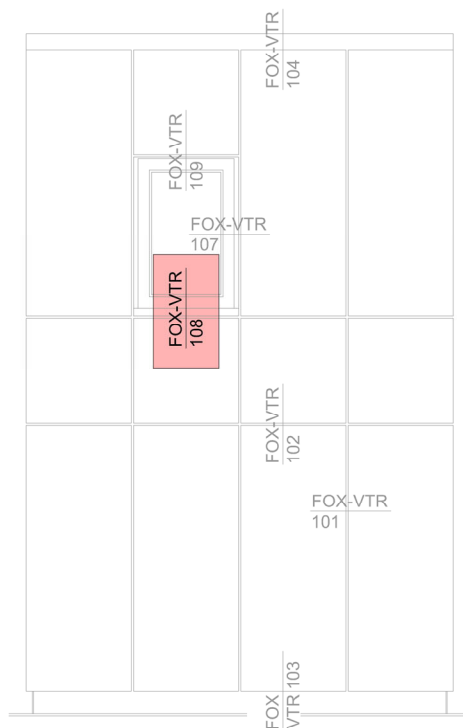
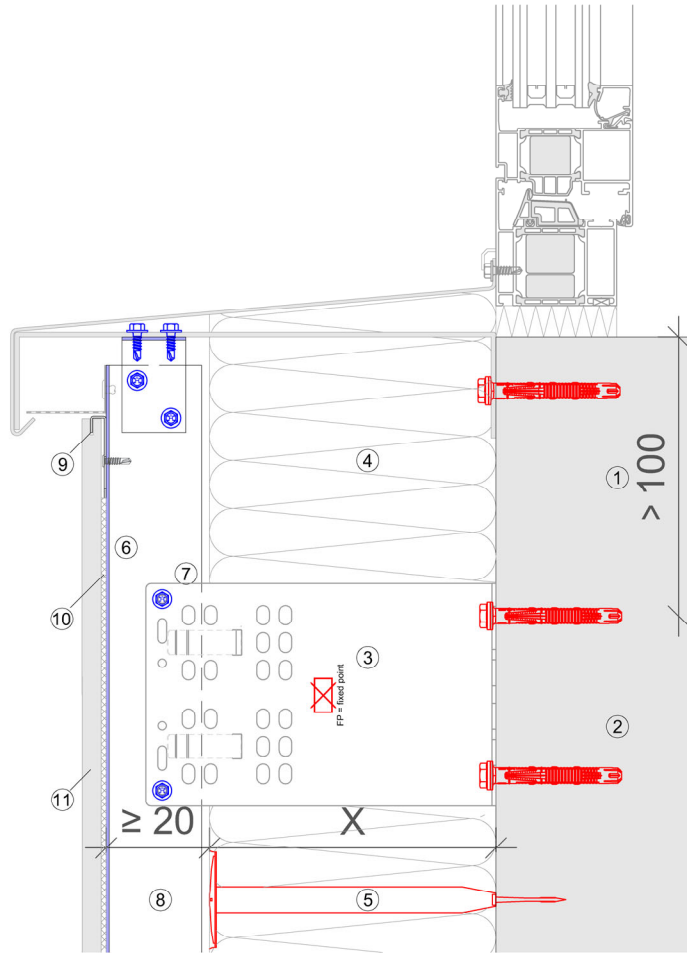

## Legend

- 1 Base material
- 2 Anchor acc. to static
- 3 Bracket + isolator
- 4 Insulation
- 5 Fixing insulation
- 6 Profile
- 7 Self drilling screw
- 8 Ventilation gap
- 9 Hidden clamp
- 10 Adhesive
- 11 Cladding



## MFT FOX VTR 109 - Window - lintel

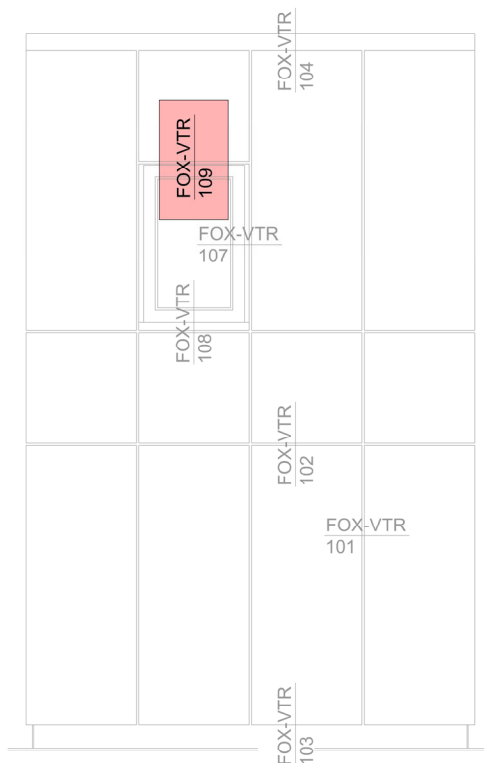
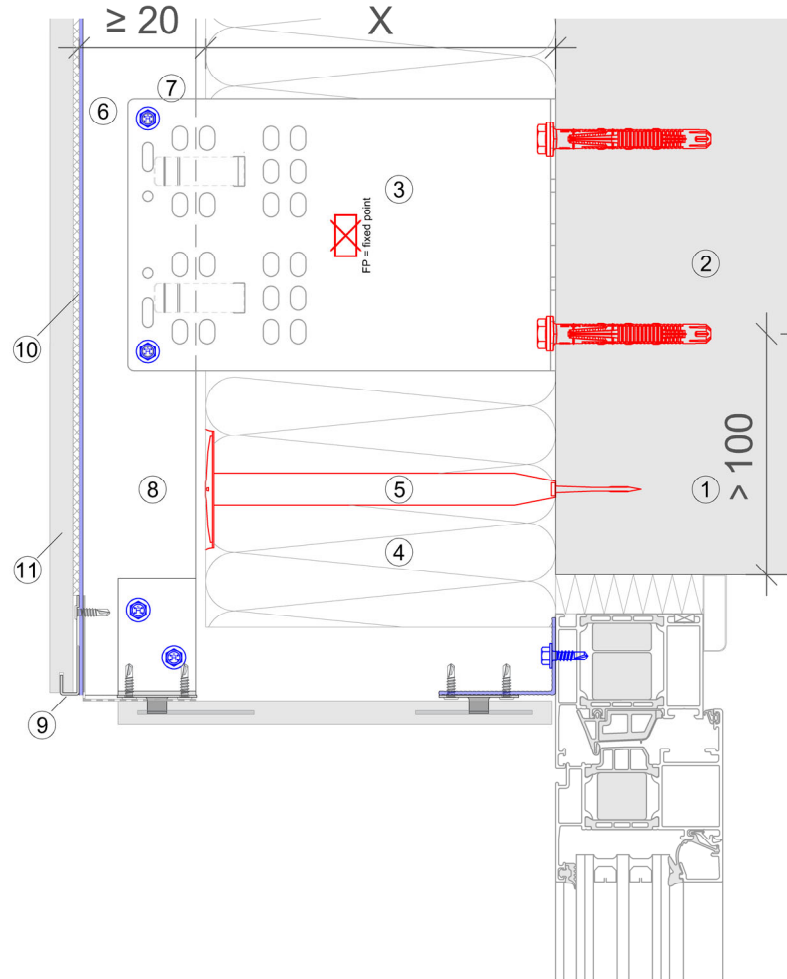

## Legend

- 1 Base material
- 2 Anchor acc. to static
- 3 Bracket + isolator
- 4 Insulation
- 5 Fixing insulation
- 6 Profile
- 7 Self drilling screw
- 8 Ventilation gap
- 9 Hidden clamp
- 10 Adhesive
- 11 Cladding



# MFT FOX VTR 109 - Window - lintel

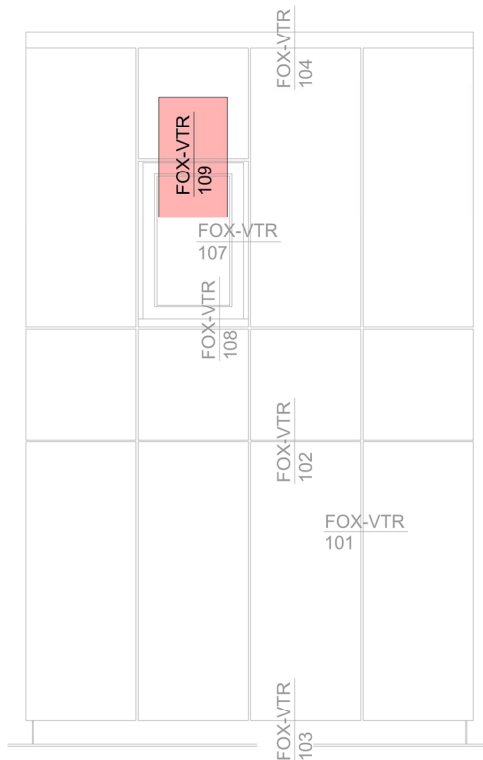
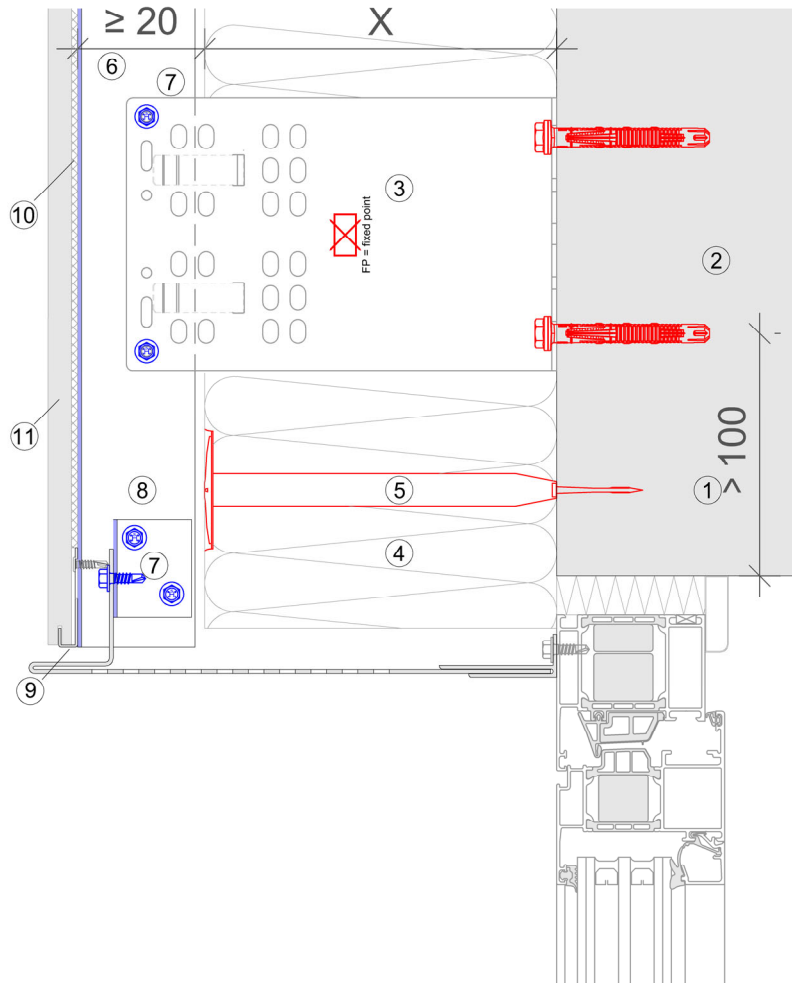

## Legend

- 1 Base material
- 2 Anchor acc. to static
- 3 Bracket + isolator
- 4 Insulation
- 5 Fixing insulation
- 6 Profile
- 7 Self drilling screw
- 8 Ventilation gap
- 9 Hidden clamp
- 10 Adhesive
- 11 Cladding





## MFT FOX VTR 109 - Window - lintel

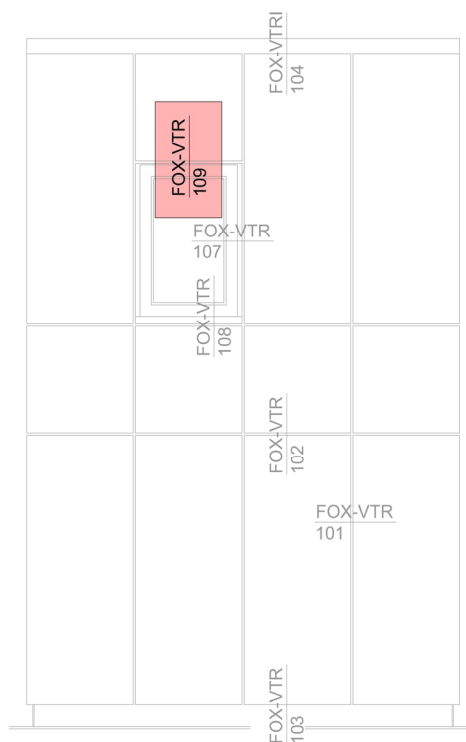
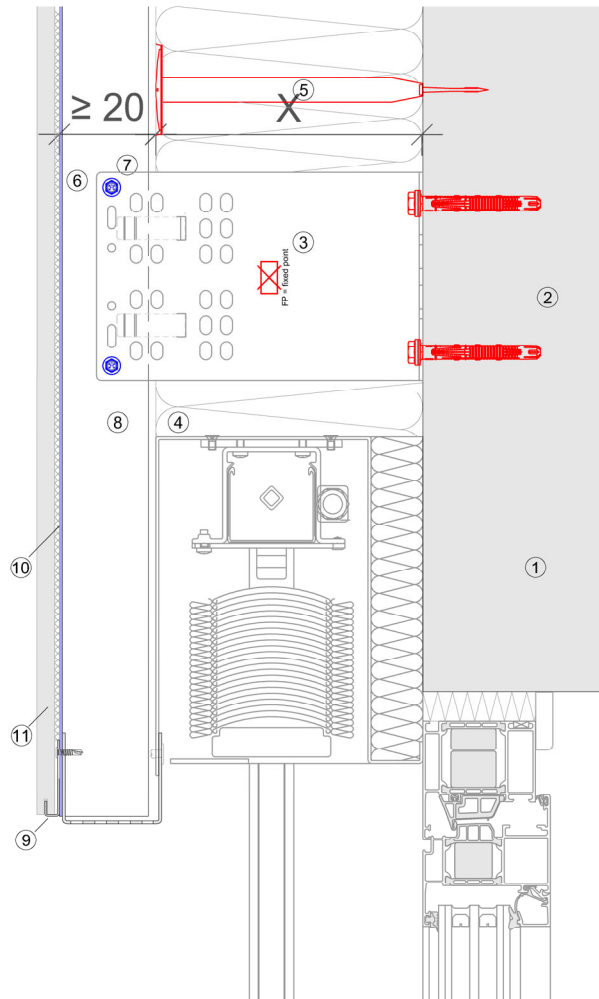

## Legend

- 1 Base material
- 2 Anchor acc. to static
- 3 Bracket + isolator
- 4 Insulation
- 5 Fixing insulation
- 6 Profile
- 7 Self drilling screw
- 8 Ventilation gap
- 9 Hidden clamp
- 10 Adhesive
- 11 Cladding