

# HILTI

**GX 3**  
**GX 3-ME**

Deutsch	de
English	en
Nederlands	nl
Français	fr
Español	es
Português	pt
Italiano	it
Dansk	da
Svenska	sv
Norsk	no
Suomi	fi
Polski	pl

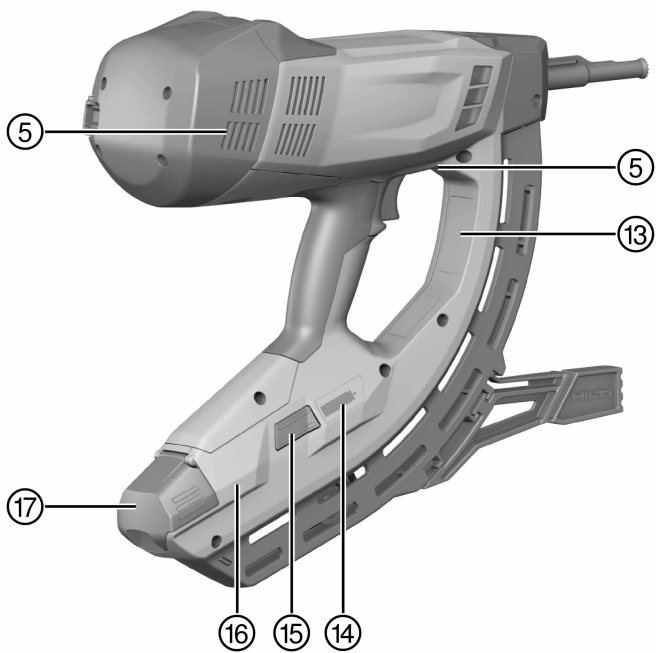

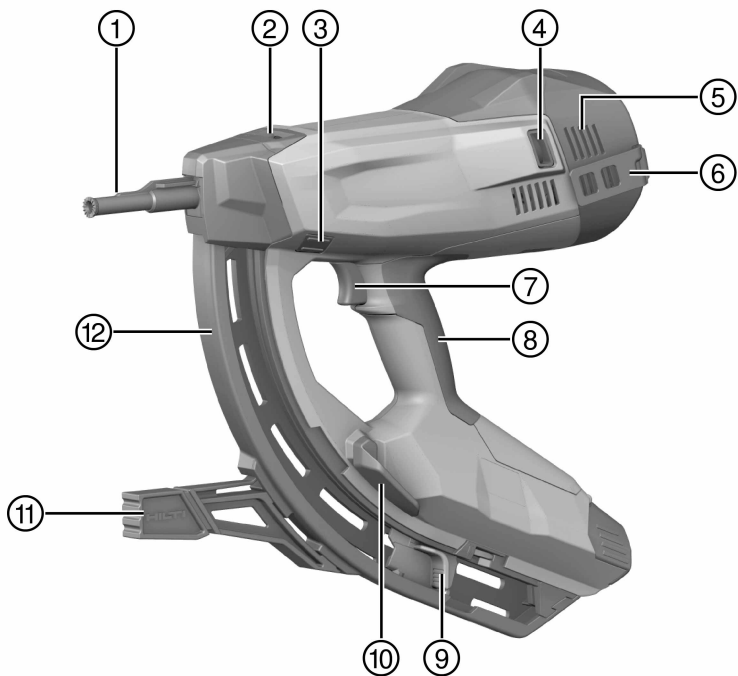

# GX 3

## GX 3-ME



de	Original-Bedienungsanleitung	1
en	Original operating instructions	15
nl	Originele handleiding	29
fr	Mode d'emploi original	43
es	Manual de instrucciones original	57
pt	Manual de instruções original	71
it	Istruzioni originali	85
da	Original brugsanvisning	99
sv	Originalbruksanvisning	112
no	Original bruksanvisning	125
fi	Alkuperäiset ohjeet	138
pl	Oryginalna instrukcja obsługi	151

## 1 Information about the documentation

### 1.1 Explanation of signs used

#### 1.1.1 Warnings

Warnings alert persons to hazards that occur when handling or using the product. The following signal words are used in combination with an icon:

	<b>DANGER!</b> Draws attention to imminent danger that will lead to serious personal injury or fatality.
	<b>WARNING!</b> Draws attention to a potentially dangerous situation that could lead to serious personal injury or fatality.
	<b>CAUTION!</b> Draws attention to a potentially dangerous situation that could lead to slight personal injury or damage to the equipment or other property.

#### 1.1.2 Symbols

The following symbols are used:

 Read the operating instructions before use

 Draws attention to instructions or other useful information

 General mandatory sign

 Wear eye protection

 Wear ear protection

 Wear a hard hat

 Return waste material for recycling

#### 1.1.3 Illustrations

The illustrations in this instruction manual are intended to convey a basic understanding and may differ from the actual version of the product:

**2** The illustrations at the beginning of this documentation are numbered with these numbers; in the text in this instruction manual, these numbers refer to the applicable illustration.

**11** Item reference numbers are used in the overview illustration. In the product overview section, the numbers shown in the legend relate to these item reference numbers.

#### 1.1.4 Highlighting of designations and markings

Designations and markings are indicated as follows:

, '	Description of marked operating controls on the setting tool.
« »	Markings on the setting tool

### 1.2 About this documentation

- ▶ It is essential that the operating instructions are read before initial operation.
- ▶ Always keep these operating instructions together with the power tool.
- ▶ Ensure that the operating instructions are with the power tool when it is given to other persons.

Changes and errors excepted.

### 1.3 Product information

Hilti products are designed for professional use and may be operated, serviced and maintained only by trained, authorized personnel. This personnel must be informed of any particular hazards that may be

encountered. The product and its ancillary equipment may present hazards when used incorrectly by untrained personnel or when used not as directed.

- ▶ Make a note of the designation and serial number printed on the rating plate in the following table.
- ▶ Always quote this information when you contact a Hilti representative or Hilti Service to enquire about the product.

**Product information**

Type:	
Generation:	01
Serial number:	

**2 Safety**

**2.1 Safety precautions**

**Working safely with the setting tool**

- ▶ Pressing the nosepiece of the setting tool against a part of the body may lead to serious injury due to inadvertent actuation and release of a fastener. **Never press the nosepiece of the tool against your hand or any other part of the body.**
- ▶ When inserting/loading application-specific fasteners (e.g. washers, clips or clamps, etc.) in/on the fastener guide there is a risk of serious injury due to inadvertent actuation of the tool resulting in discharge of a fastener. **When inserting/loading an application-specific type of fastener, never press a hand or any other part of the body against the fastener guide.**
- ▶ **Never point the setting tool towards yourself or any other person.**
- ▶ **Keep your arms flexed when operating the tool (do not straighten the arms).**
- ▶ **Stay alert, watch what you are doing and use common sense when operating the setting tool. Do not use the setting tool while you are tired or under the influence of drugs, alcohol or medication.** A moment of inattention while operating the setting tool may result in serious personal injury.
- ▶ When pulling back the nail pusher, always take care to ensure that it engages.
- ▶ **When disengaging the nail pusher, do not release it and allow it to jump forward. Guide it forward slowly.** There is a risk of pinching the fingers.
- ▶ Do not attempt to drive fasteners into **materials that are too hard**, such as welded steel or cast steel. Attempting to drive fasteners into these materials may lead to malfunctions, incorrectly driven fasteners or breakage of fasteners.
- ▶ Do not attempt to drive fasteners into **materials that are too soft**, such as wood or drywall/gypsum board. Attempting to drive fasteners into these materials may lead to malfunctions and fasteners being driven incorrectly or driven right through the material.
- ▶ Do not attempt to drive fasteners into **materials that are too brittle**, such as glass or tiles. Attempting to drive fasteners into these materials may lead to malfunctions, fasteners being driven incorrectly and may cause the material to shatter.
- ▶ Before driving fasteners, check that there is no risk of injuring persons or of damaging objects present behind or below the working surface.
- ▶ Only activate the trigger when the setting tool is pressed against the base material in such a way that the fastener guide is plunged into the setting tool as far as it will go.
- ▶ **Always wear gloves if you have to carry out maintenance work on the setting tool while it is still hot.**
- ▶ If fasteners are driven at a high rate or if the tool used for a long period, surfaces of the tool beyond the grip areas may get hot. Wear protective gloves to avoid burning injuries.
- ▶ If the setting tool overheats, remove the gas can and allow the tool to cool down. Do not exceed the specified maximum fastener driving rate.
- ▶ Driving fasteners may cause flying fragments or result in parts of the nail strip material being forcibly ejected from the tool. Flying fragments present a risk of injury to the body and eyes. **Wear a suitable form of eye protection, ear protectors and a hard hat.** Depending on the application and type of tool in use, wearing personal protective equipment such as a dust mask, non-slip safety footwear, hard hat or suitable eye protection and ear protection reduces the risk of injury. Other persons in the vicinity must also wear eye protection and a hard hat.
- ▶ Wear suitable ear protection (see noise information in the technical data section). The fastener is driven by the energy released on ignition of a gas-air mixture. The resulting noise exposure may cause damage to the hearing. Other persons in the vicinity should also wear suitable ear protection.

- ▶ When driving a fastener, always hold the setting tool securely and at right angles to the supporting material. This helps to avoid deflection of the fastener by the supporting material.
- ▶ Never drive a second fastener at the same location. This may lead to breakage or jamming of fasteners.
- ▶ **Never attempt to redrive a previously driven stud or nail.** Re-use of a fastener may cause it to break, thereby presenting a risk of injury.
- ▶ Always remove the gas can and ( → page 22) empty the magazine ( → page 22) before changing the magazine, before cleaning, servicing or maintenance work on the tool, before storage or transport and before leaving the setting tool unattended.
- ▶ After use, lay the tool flat on the floor. A tool that is mounted on a pole tool extension and left leaning against a wall presents a risk of injury as it may fall over.
- ▶ When lowering (tilting) the pole tool extension, do not hold the pole only at its lower end. The considerable leverage exerted may cause you to lose control over the tilting movement of the pole and tool. This may result in injury and damage to the equipment or other property.
- ▶ To ensure that the setting tool functions faultlessly and as intended, always check the tool and accessories for possible damage before use. Check that moving parts function faultlessly, without sticking, and that no parts are damaged. In order to ensure faultless operation of the tool, all parts must be fitted correctly and must meet the necessary requirements. Damaged protective devices or other parts must be properly repaired or replaced by **Hilti Service** unless otherwise stated in the operating instructions.
- ▶ Have the setting tool repaired only by trained and qualified specialists using genuine Hilti spare parts. This will ensure that the safety of the setting tool is maintained.
- ▶ Tampering with or modification of the setting tool is not permissible.
- ▶ **Do not use the setting tool where there is a risk of fire or explosion.**
- ▶ Take influences of the surrounding area into account. Do not expose the setting tool to rain or snow and do not use it in damp or wet conditions.
- ▶ Use the setting tool only in well-ventilated working areas.
- ▶ Select the correct combination of fastener guide and fastener. The wrong combination may result in damage to the tool and in reduced fastening quality.
- ▶ Always observe the application guidelines → page 18.

#### **Hazards presented by electricity**

- ▶ Before beginning work, check the working area (e.g. using a metal detector) to ensure that no concealed electric cables or gas and water pipes are present.
- ▶ Hold the setting tool only by the insulated grip when working in areas where fasteners may be driven inadvertently into concealed electric cables. Contact with a live electric cable may cause metal parts of the tool also to become live, leading to a risk of electric shock.

#### **Instructions for handling the propellant gas**

- ▶ Observe the instructions printed on the gas can and in the accompanying information.
- ▶ Escaping gas is harmful to the lungs, skin and eyes. Keep your face and eyes away from the gas can compartment for up to about 10 seconds after removing the gas can.
- ▶ Do not operate the gas can valve manually.
- ▶ If a person has inhaled gas, take the person into the open air or into a well-ventilated area and place the person in a comfortable position. Consult a doctor if necessary.
- ▶ **Call a doctor if the person is unconscious.** Bring the person into a well-ventilated area and place the person in the stable recovery position (i.e. lying on the side). If the person is not breathing, administer artificial respiration and, if necessary, supply oxygen.
- ▶ After eye contact with gas, rinse the open eyes thoroughly under running water for several minutes.
- ▶ After skin contact with gas, wash the contact area carefully with soap and warm water. Subsequently apply a skin cream.

#### **General instructions concerning personal safety**

- ▶ Take care to adopt an ergonomic body position. Work from a safe stance and take care to stay in balance at all times. This will allow you to control the setting tool better, even in unexpected situations.
- ▶ Keep other people away from the working area, especially children.

## **3 Description**

### **3.1 Overview of the product 1**

- |   |   |
|---|---|
| <ul style="list-style-type: none"> <li>① Fastener guide</li> <li>② Slider for fastener driving depth adjustment and for releasing the fastener guide</li> </ul> | <ul style="list-style-type: none"> <li>③ <b>RESET</b> button</li> <li>④ Inlet/outlet valve</li> </ul> |
|---|---|

- ⑤ Cooling air slots
- ⑥ Belt hook
- ⑦ Trigger
- ⑧ Grip
- ⑨ Nail pusher
- ⑩ Magazine lockbutton
- ⑪ Support leg

- ⑫ Magazine
- ⑬ Type identification plate
- ⑭ Gas can status indicator
- ⑮ **GAS** button
- ⑯ Gas can compartment
- ⑰ Gas can compartment cover

### 3.2 Intended use

The product described is a gas-actuated fastening tool ("fastening tool"). It is designed to drive suitable fasteners into concrete, steel, concrete-block masonry, sand-lime block, rendered masonry and other materials suitable for use of the direct fastening technique.

Further details can be found in the **Fastening Technology Manual** copies of which can be obtained from a **Hilti** Service Center or from the following address:

Internet: <http://www.hilti.com>

The fastening tool is designed for professional use in drywall construction, general construction work and in various installation trades.

The fastening tool, gas can and fasteners form a technical unit. This means that trouble-free fastening with this fastening tool can be ensured only when it is used together with the fasteners and gas cans specially manufactured for it by **Hilti**. The fastening and application recommendations made by **Hilti** apply only when this condition is observed.

This fastening tool may be used only hand held or in conjunction with the special "pole tool" extension (accessory).

### 3.3 Items supplied

Gas-actuated setting tool with fastener guide, toolbox, operating instructions.

You can find other system products approved for your product at your local **Hilti** Center or online at: [www.hilti.com](http://www.hilti.com)

### 3.4 Fastener guide

The fastener guide holds the studs or, respectively, guides the nails and, when the tool is fired, thus directs the fasteners into the supporting material at the desired position. Application-specific fastener guides (IF or ME) are available for the **GX 3** and **GX 3-ME** fastening tools (see type identification plate for exact designation).

### 3.5 Fasteners

Two types of fastener can be driven by the fastening tool: nails and threaded studs. Additional fastening components, which can be inserted in the fastener guide, are also available for various applications.

### 3.6 Guidelines for use on concrete and steel



Information about national regulations, and the **Fastening Technology Manual** containing further information, are available from the **Hilti** marketing organization responsible for your location.

The **Fastening Technology Manual** can also be obtained from:

Internet: <http://www.hilti.com>

### 3.7 Slider for fastener driving depth adjustment and for releasing the fastener guide

The slider can be used to reduce the depth to which the fastener is driven. In the **EJECT** position, it releases the fastener guide for removal.

Status	Meaning
	<ul style="list-style-type: none"> <li>• Standard fastener driving depth</li> </ul>
	<ul style="list-style-type: none"> <li>• Reduced fastener driving depth</li> </ul>
<b>EJECT</b>	<ul style="list-style-type: none"> <li>• Fastener guide release</li> </ul>

### 3.8 RESET button

After driving a fastener, under certain circumstances, the fastener guide may not return to its outset position. This is caused by the piston being incorrectly positioned. The incorrect piston position can be remedied by pressing the **RESET** button.

Status	Meaning
<b>RESET</b> button projects from the tool casing. Its white edge is visible.	<ul style="list-style-type: none"> <li>Piston position is incorrect</li> </ul>
<b>RESET</b> button is flush with the tool casing.	<ul style="list-style-type: none"> <li>Piston position is correct</li> </ul>

### 3.9 Support leg

On an even working surface, the support leg makes it easier to hold the fastening tool perpendicular as attention then only has to be paid to lateral alignment. On an uneven or undulating surface it may be necessary to remove the support leg in order to allow the fastener guide to be held perpendicular to the working surface.

### 3.10 Belt hook

The belt hook can be extended in two stages.

Status	Meaning
First position	<ul style="list-style-type: none"> <li>Position for attaching to a waist belt</li> </ul>
Second position	<ul style="list-style-type: none"> <li>Position for attaching to ladders, scaffolds, platforms, etc.</li> </ul>

### 3.11 Gas can



#### Note

Observe the safety instructions provided with the gas can!

In order to operate the fastening tool, the gas can must be inserted in the gas can compartment.

The gas can status can be read from the LED display after pressing the **GAS** button.

The gas can must be removed before breaks between working, before maintenance and before transporting or storing the fastening tool.

### 3.12 Indication of gas can status

After pressing the **GAS** button, the LED display indicates the status of the gas can.



#### Note

The fill level indicator does not operate correctly if the fastener guide has been fully plunged into the tool.

Status	Meaning
All four LEDs light green.	<ul style="list-style-type: none"> <li>Level is approx. 100 %.</li> </ul>
Three LEDs light green.	<ul style="list-style-type: none"> <li>Level is approx. 75 %.</li> </ul>
Two LEDs light green.	<ul style="list-style-type: none"> <li>Level is approx. 50 %.</li> </ul>
One LED lights green.	<ul style="list-style-type: none"> <li>Level is approx. 25 %.</li> </ul>
One LED blinks green.	<ul style="list-style-type: none"> <li>Level is below 10 %. Replacement of the gas can is recommended.</li> </ul>
One LED lights red.	<ul style="list-style-type: none"> <li>There is either no gas can in the setting tool, the wrong type of gas can is fitted or the can is empty.</li> </ul> <p><b>Note</b> Even when the level is indicated as “empty”, the gas can, for technical reasons, still contains a little gas.</p>

## 4 Technical data

### 4.1 Fastening tool

<b>Weight (empty)</b>	3.9 kg
<b>Application temperature, ambient temperature</b>	-10 °C ... 45 °C
<b>Maximum fastener length</b>	39 mm



<b>Fastener diameter</b>	<ul style="list-style-type: none"> <li>• 2.6 mm</li> <li>• 3.0 mm</li> </ul>
<b>Compression stroke</b>	40 mm
<b>Magazine capacity</b>	40 + 2 nails
<b>Maximum fastener driving frequency (Fasteners per hour)</b>	1,200

#### 4.2 Noise information and vibration values

The sound pressure and vibration values given in these instructions have been measured in accordance with a standardized test and may be used to compare one fastening tool with another. They may be used for a preliminary assessment of exposure. The data given represents the main applications of the fastening tool. However, if the fastening tool is used for different applications, with different accessories or is poorly maintained, the data may vary. This may significantly increase exposure over the total working period. An estimation of the level of exposure should also take into account the periods of time when the tool is not actually in use. This may significantly reduce exposure over the total working period. Prescribe additional safety measures to protect the operator from the effects of noise and/or vibration, such as: maintenance of the direct fastening tool and its additional equipment or accessories, keeping the hands warm, organization of work patterns.

#### Noise emission values determined in accordance with EN 15895

<b>Emission sound pressure level at the workplace (<math>L_{pA, 1s}</math>)</b>	99 dB(A)
<b>Peak sound pressure level at the workplace (<math>L_{pC, peak}</math>)</b>	133 dB (C)
<b>Sound (power) level (<math>L_{WA}</math>)</b>	105 dB(A)
<b>Sound level uncertainty</b>	2 dB(A) / 2 dB(C)

#### Recoil

<b>Energy-equivalent acceleration, (<math>a_{hw, RMS(3)}</math>)</b>	Applicable to 1 mm sheet metal on B35 concrete: 3.64 m/s <sup>2</sup>
<b>Measurement uncertainty</b>	0.13 m/s <sup>2</sup>

## 5 Loading the setting tool

### 5.1 Loading for driving nails

#### 5.1.1 Equipment required for driving nails

Nails are fed through the magazine in strip form (ready-to-use strips of nails).



#### Note

When driving nails there must be no single-fastener adapter present in the tool .

#### 5.1.2 Loading the magazine

1. Pull the nail pusher back until it engages.
2. Slide the nail strips into the magazine as far as they will go.



#### Note

Strips of short nails could be inadvertently inserted the wrong way round. With short nails, take care to ensure that the tips of the nails point towards the nose of the tool.



#### WARNING

**Risk of finger injury!** Fingers could be pinched when the nail pusher is released.

- ▶ When disengaging the nail pusher, do not release it and allow it to jump forward. Guide it forward slowly as far as it will go.

3. Release the nail pusher and guide it forward as far as it will go.

#### 5.1.3 Inserting the gas can

1. Open the gas can compartment cover.

2. Remove the cap from the gas can.

**Note**

Keep the cap so that it can be used to close the gas can securely when it is removed from the tool, e.g. when unloading and for transport.

3. Slide the gas can into the gas can compartment, valve first, so that the gas can clip enters the opening for the clip and engages securely.
4. Close the gas can compartment cover.
5. Without pulling the trigger, firmly press the setting tool with the fastener guide three times against the base material in order to bleed the gas lines of air.

## 5.2 Loading for driving threaded studs

### 5.2.1 Equipment required for driving threaded studs

Threaded studs must be inserted singly in the fastener guide from the front. An adapter is required for driving single fasteners. The packaging units for threaded studs each contain an adapter for individual setting, with the corresponding fitting information.

**Note**

In order to drive threaded studs, the magazine must first be emptied and an adapter for driving single fasteners inserted.

### 5.2.2 Inserting the single-fastener adapter

- ▶ Insert the single-fastener adapter ( → page 23).

### 5.2.3 Inserting the gas can

- ▶ Insert the gas can ( → page 20).

## 6 Driving fasteners

### 6.1 Driving nails

**WARNING**

**Risk of injury!** Pressing the nosepiece of the fastening tool against a part of the body may lead to serious injury due to inadvertent firing and release of a fastener.

- ▶ **Never press the nosepiece of the tool against your hand or any other part of the body.**

1. Check the fastener driving depth setting.
2. Bring the nosepiece of the setting tool and the support leg into contact with the working surface.
3. Using the fastener guide, press the setting tool as far as it will go against the base material.
4. Check that the fastener guide is perpendicular to the working surface.
5. Pull the trigger to drive a fastener.

**Note**

It is not possible to drive a fastener if the fastener guide is not pressed fully against the working surface.

6. Lift the fastening tool completely away from the working surface after driving a fastener.
7. Remove the gas can ( → page 22) and empty the magazine ( → page 22) when work with the setting tool is finished or before leaving the tool unattended.

### 6.2 Driving threaded studs

**WARNING**

**Risk of injury!** Pressing the nosepiece of the setting tool against a part of the body may lead to serious injury due to inadvertent firing and release of a fastener.

- ▶ **When inserting fasteners, on no occasion press the fastener guide against a hand or any other part of the body.**
- ▶ **Never press the nosepiece of the tool against your hand or any other part of the body.**



## WARNING

**Risk of injury by falling objects!** Triggering the tool again on top of a nail or stud that was not optimally driven may weaken the fastening. The object that was fastened may fall down as a result, causing damage or injury.

- ▶ **Never trigger the tool again in an attempt to improve the hold of a previously driven nail or stud.**

1. Check the fastener driving depth setting.
2. Insert a stud in the fastener guide.
3. Bring the nosepiece of the setting tool and the support leg into contact with the working surface.
4. Using the fastener guide, press the setting tool as far as it will go against the base material.
5. Check that the fastener guide is perpendicular to the working surface.
6. Pull the trigger to drive a fastener.



## Note

It is not possible to drive a fastener if the fastener guide is not pressed fully against the working surface.

7. Remove the gas can when work with the setting tool is finished or before leaving the tool unattended ( → page 22).

## 7 Unloading the setting tool

### 7.1 Removing the gas can

1. Open the gas can compartment cover.
2. Press the gas can clip to release the gas can.
3. Remove the gas can from the gas can compartment.
4. Fit the cap on the gas can.
5. Close the gas can compartment cover.

### 7.2 Unloading the magazine

1. Pull the nail pusher back until it engages.
2. Remove all nail strips from the magazine.



## WARNING

**Risk of finger injury!** Fingers could be pinched when the nail pusher is released.

- ▶ When disengaging the nail pusher, do not release it and allow it to jump forward. Guide it forward slowly as far as it will go.

3. Release the nail pusher and guide it forward as far as it will go.

### 7.3 Removing the single-fastener adapter

- ▶ After driving the fasteners, remove the single-fastener adapter ( → page 23) from the fastening tool.

## 8 Optional operating steps

### 8.1 Checking the status of the gas can

1. Without pressing the fastening tool against the working surface, press the **GAS** button.
2. Read the gas can status from the display. → page 19

### 8.2 Removing the magazine

1. Pull the nail pusher back until it engages.
2. Remove the loose nail strips from the magazine.



## **WARNING**

**Risk of finger injury!** Fingers could be pinched when the nail pusher is released.

- ▶ When disengaging the nail pusher, do not release it and allow it to jump forward. Guide it forward slowly as far as it will go.

3. Release the nail pusher and guide it forward as far as it will go.
4. Release the magazine locking catch.
5. Pivot the magazine about the pivot point towards the front.
6. Detach the magazine.

### **8.3 Fitting the magazine**

1. Release the magazine locking catch.
2. Engage the front end of the magazine with the setting tool.
3. Pivot the magazine towards the setting tool as far as it will go.
4. Close the magazine locking catch.

### **8.4 Removing the fastener guide**

1. Remove the gas can. → page 22
2. Move the fastener guide release slider to the **EJECT** position.
3. Remove the fastener guide.

### **8.5 Inserting the fastener guide**

1. Remove the gas can. → page 22
2. Slide the fastener guide into the slot in the nose of the fastening tool.
3. Hold the fastener guide securely so that it cannot fall out and then press the nose of the tool (i.e. the tool with the fastener guide) against a firm surface until the fastener guide engages.
4. Check that the fastener guide has engaged.
  - ◀ Once the fastener guide has engaged, the slider for releasing the fastener guide is again in the **+** position.

### **8.6 Removing the support leg**

1. Release the support leg engaging mechanism by pressing lightly.
2. Rotate the support leg through 90°.
3. Remove the support leg.

### **8.7 Fitting the support leg**

1. Bring the support leg into contact with the magazine at right angles and guide it into the slot.
2. Rotate the support leg through 90° relative to the magazine and allow it to engage while applying light pressure.

### **8.8 Inserting the single-fastener adapter**

1. Remove the gas can. → page 22
2. Remove the magazine. → page 22
3. Insert the single-fastener adapter.
4. Fit the magazine. → page 23

### **8.9 Removing the single-fastener adapter**

1. Remove the gas can. → page 22
2. Remove the magazine. → page 22
3. Remove the single-fastener adapter.
4. Fit the magazine. → page 23

## 9 Remediating possible malfunctions

### 9.1 Remediating an incorrect piston position

- ▶ Check the position of the **RESET** → page 18 button.

#### Result

- **RESET** button projects from the tool casing. Its white edge is visible.

To remedy the incorrect piston position, press the **RESET** button.

### 9.2 Removing foreign objects and nails from the area around the fastener guide



#### CAUTION

**Risk of injury by flying parts!** Triggering the tool (attempting to drive a fastener) when foreign objects are present in the area around the fastener guide, or when a fastener is jammed in the fastener guide, may lead to injury caused by flying objects or fragments.

- ▶ Never attempt to remedy tool malfunctions by continuing to trigger the tool!

1. Remove the gas can. → page 22
2. Unload the magazine. → page 22
3. Remove the magazine. → page 22
4. Remove the fastener guide. → page 23
5. Remove all foreign objects and nails from the area around the fastener guide.
6. Insert the fastener guide. → page 23
7. Fit the magazine. → page 23

## 10 Care and maintenance

### 10.1 Caring for the fastening tool

- ▶ Never operate the fastening tool if the cooling air slots are blocked.
- ▶ Keep the grip areas free from oil and grease.
- ▶ Clean the fastening tool regularly. → page 24
- ▶ Do not use spray devices, pressure jet washers or running water for cleaning.
- ▶ Do not use cleaning agents containing silicone.
- ▶ Do not use sprays or similar lubricating and cleaning agents.

### 10.2 Cleaning the fastening tool

1. Remove the gas can. → page 22
2. Unload the magazine. → page 22
3. Remove plastic fragments from the fastener guide.
4. Use a dry brush to clean the cooling air slots, taking care to prevent dirt or foreign objects entering the interior of the tool.
5. Use a damp cloth to clean the exterior of the tool.

## 11 Transport and storage

### 11.1 Maintenance





- ▶ To help ensure safe and reliable operation, use only genuine Hilti spare parts and consumables. Spare parts, consumables and accessories approved by Hilti for use with the product can be found at your local **Hilti Center** or online at: [www.hilti.com](http://www.hilti.com).
- ▶ Check all external parts of the setting tool regularly for damage and make sure that all operating controls function faultlessly.
- ▶ Do not use the setting tool if parts are damaged or if operating controls do not function faultlessly.
- ▶ Have a defective setting tool repaired by **Hilti Service**.

### 11.2 Checks after care and maintenance work

- ▶ Move the fastener driving depth adjustment slider to the **+** position.

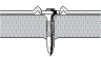
## 12 Troubleshooting

If the trouble you are experiencing is not listed in this table or you are unable to remedy the problem by yourself, please contact **Hilti Service**.

Malfunction	Possible cause	Action to be taken
 <p>Fasteners are frequently driven to inadequate depth.</p>	Driving power is too low.	► Move the fastener driving depth adjustment slider to the <b>+</b> position.
	The fasteners are too long.	► Use shorter fasteners.
	The supporting material is too hard.	► Consider using a DX fastening tool.
	The inlet/outlet valve is clogged or covered over.	► Clean the fastening tool and check how it is held.
 <p>Fasteners are frequently driven too deeply.</p>	Driving power is too high.	► Move the fastener driving depth adjustment slider to the <b>-</b> position.
	The fasteners are too short.	► Use longer fasteners.
 <p>Fasteners break.</p>	Driving power is too low.	► Move the fastener driving depth adjustment slider to the <b>+</b> position.
	The fasteners are too long.	► Use shorter fasteners.
	The supporting material is too hard.	► Consider using a DX fastening tool.
	The fastener guide is not held perpendicular to the working surface.	► Press the nosepiece against the working surface while keeping the tool perpendicular to the surface.
 <p>Fasteners bend.</p>	Driving power is too low.	► Move the fastener driving depth adjustment slider to the <b>+</b> position.
	The fasteners are too long.	► Use shorter fasteners.
	The fastener guide is not held perpendicular to the working surface.	► Press the nosepiece against the working surface while keeping the tool perpendicular to the surface.
 <p>Fasteners do not hold in steel base material.</p>	The supporting material is too thin.	► Use a different fastening method.
The content of the gas can be inadequate for the number of fasteners in the package.	High gas consumption due to frequent compression of the tool nosepiece without driving a fastener.	► Avoid compressing the tool nosepiece without driving a fastener.
<p>The tool remains compressed (nose does not extend when pressure is released).</p>	Incorrect piston position.	► Remedy the incorrect piston position. → page 24
	The nail detector is jammed and the <b>RESET</b> button is not flush with the casing when pressed.	► Remove foreign objects and nails from the area around the fastener guide. → page 24
	A fastener has jammed in the fastener guide.	► Release the jammed fastener.

<b>Malfunction</b>	<b>Possible cause</b>	<b>Action to be taken</b>
Fastener driving failure rate is too high.	The fastener guide is not held perpendicular to the working surface.	▶ Press the nosepiece against the working surface while keeping the tool perpendicular to the surface.
	Wrong type of fastener used.	▶ Use a suitable type of fastener.
	The supporting material is too hard.	▶ Consider using a DX fastening tool.
No fastener is driven.	The nail pusher was not moved forward.	▶ Release the nail pusher and guide it forward as far as it will go.
	Insufficient nails in the magazine (2 nails or fewer).	▶ Load the magazine. → page 20
	Nail transport malfunction.	▶ Use a different nail strip.
		▶ Clean the magazine.
	Gas can is empty.	▶ Check the status of the gas can. → page 22
	LED 1 lights red	▶ Check the status of the gas can. → page 22
	Air in the gas lines	▶ Press the setting tool three times in position without pulling the trigger.
	Foreign object in the area of the fastener guide	▶ Remove foreign objects and nails from the area around the fastener guide. → page 24
The fastening tool is too hot.	▶ Allow the fastening tool to cool down.	
The fastening tool is hot and doesn't work even after a break.	The fastener driving rate was well above 1,200 fastenings per hour.	▶ Remove the gas can and then reinsert it. If the problem persists, use a new gas can.
		▶ Allow the fastening tool to cool down.
No fastener is driven (or driven only intermittently).	Ambient conditions are outside the permissible range.	▶ Make sure that the permissible ranges, in accordance with the technical data, are observed.
	The gas can temperature is outside the permissible range.	▶ Make sure that the permissible ranges, in accordance with the technical data, are observed.
	Gas bubbles have formed in the gas regulating system.	▶ Remove the gas can and then reinsert it.
	The tool was not lifted completely away from the surface after driving a fastener.	▶ Lift the fastening tool completely away from the working surface after driving a fastener.
A fastener cannot be removed from the fastener guide.	A fastener has jammed in the fastener guide.	▶ Release the jammed fastener.

### 13 Disposal

 Most of the materials from which **Hilti** tools and appliances are manufactured can be recycled. The materials must be correctly separated before they can be recycled. In many countries, your old tools, machines or appliances can be returned to **Hilti** for recycling. Ask **Hilti** Service or your Hilti representative for further information.

In accordance with the European Directive on waste electrical and electronic equipment and its implementation in conformance with national law, electric tools or appliances that have reached the end of their life must be collected separately and returned to an environmentally compatible recycling facility.



- 
- Disposal of electric tools or appliances together with household waste is not permissible.
- 

#### 14 Manufacturer's warranty

- Please contact your local **Hilti** representative if you have questions about the warranty conditions.

#### 15 FCC statement (applicable in US) / IC statement (applicable in Canada)

This device complies with Part 15 of the FCC Rules and RSS-210 of IC. Operation is subject to the following two conditions:

1. This device shall cause no harmful interference.
2. This device must accept any interference received, including interference that may cause undesired operation.

#### 16 EC declaration of conformity

##### Manufacturer

Hilti Aktiengesellschaft  
Feldkircherstrasse 100  
9494 Schaan  
**Liechtenstein**

We declare, on our sole responsibility, that this product complies with the following directives and standards.

Designation	Gas-actuated fastening tool
Type designation	GX 3
Generation	01
Year of design	2015
Type designation	GX 3-ME
Generation	01
Year of design	2015
Applicable directives:	<ul style="list-style-type: none"><li>• 1999/5/EC</li><li>• 2006/42/EC</li><li>• 2006/66/EC</li><li>• 2011/65/EU</li><li>• 2004/108/EC (up to April 19, 2016)</li><li>• 2014/30/EU (as of April 20, 2016)</li></ul>
Applicable standards:	<ul style="list-style-type: none"><li>• EN 792-13</li><li>• EN ISO 12100</li><li>• EN 300 330-1 V1.7.1</li><li>• EN 300 330-2 V1.5.1</li><li>• EN 301 489-1 V1.9.2, EN 301 489-3 V1.6.1</li></ul>



Technical documentation filed at:

- Electric Tools Approval Department  
Hilti Entwicklungsgesellschaft mbH  
Hiltistraße 6  
86916 Kaufering  
**Germany**

Schaan, 8/2015



Norbert Wohlwend  
(Head of BA Quality and Process Management /  
Business Unit Direct Fastening)

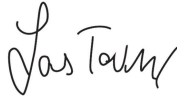

Dr. Lars Tänzer  
(Head of BU Direct Fastening)



Hilti Corporation

LI-9494 Schaan

Tel.: +423/234 21 11

Fax: +423/234 29 65

[www.hilti.com](http://www.hilti.com)



21266638