

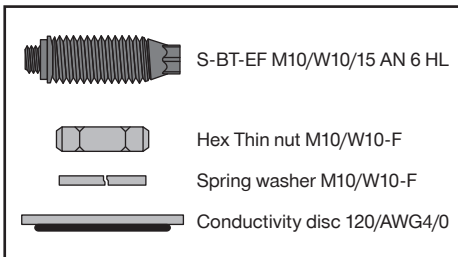

S-BT-EF M10/W10 HC HL

2353585-03.2023

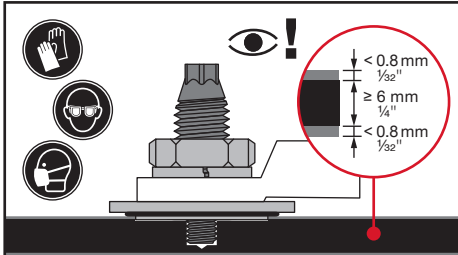

	SBT 4	SBT 6 SF 6
	TS-BT 5.3-65 S	
	TS-BT 5.3 HC	
	S-DG BT M10-W10/15 HC 6	
	Torque Tool S-BT 1/4" 16 Nm / 11.8 lb-ft	
	S-NS P 1/4" HKH 17 (M10) S-NS 9/16" C 95/3 1/4" (W10)	
	S-CC BT HC 6	

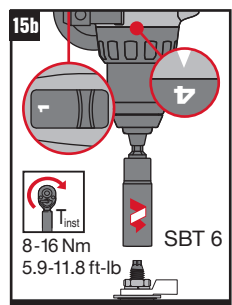
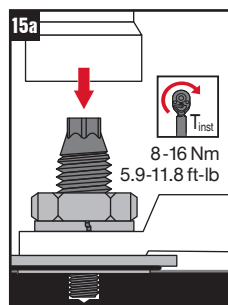
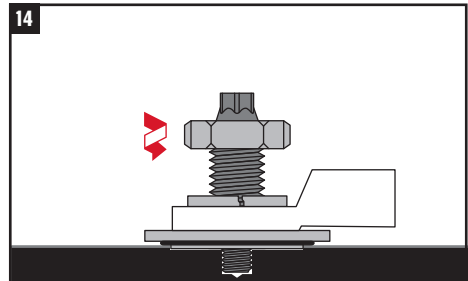
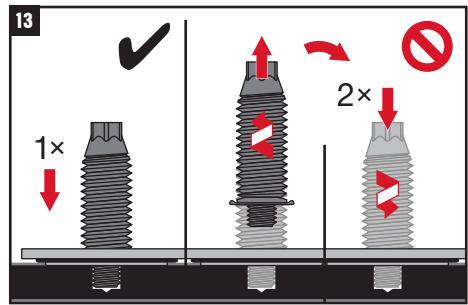
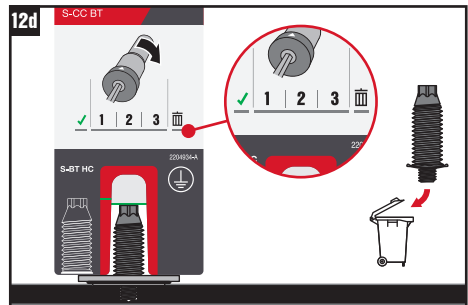
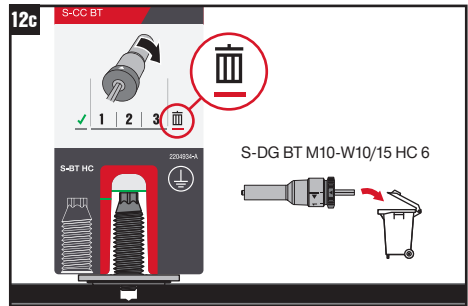
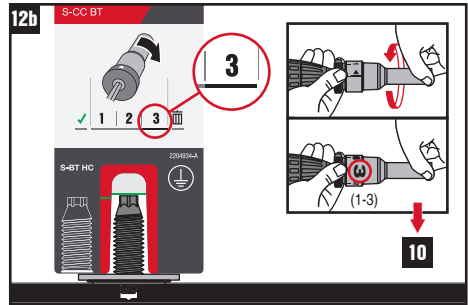
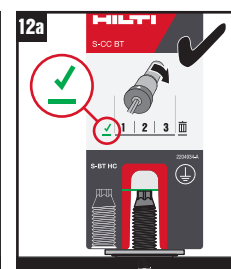
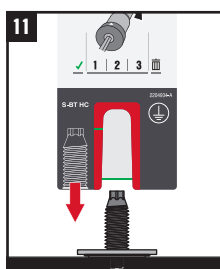
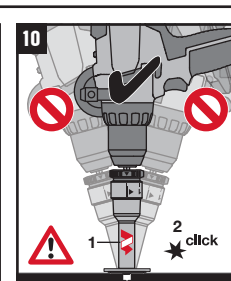
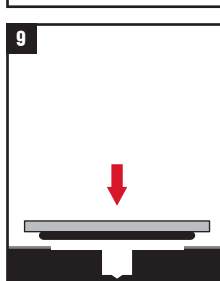
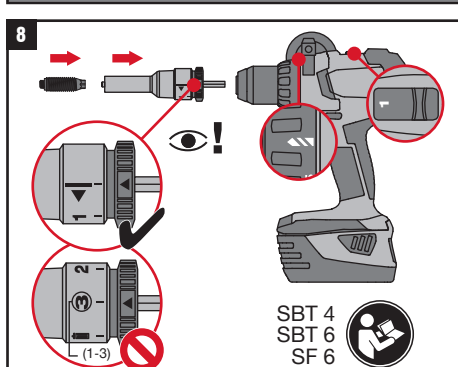
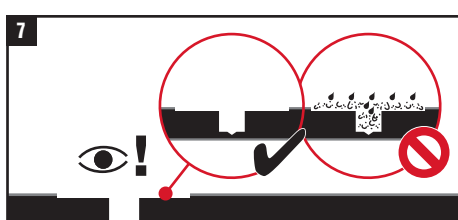
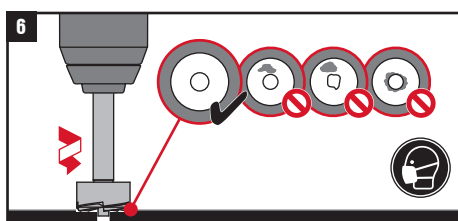
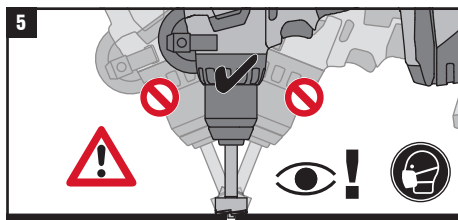
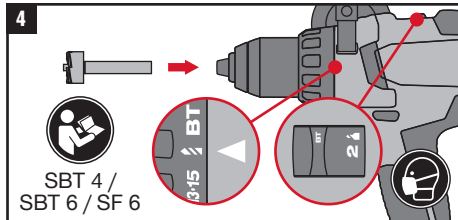
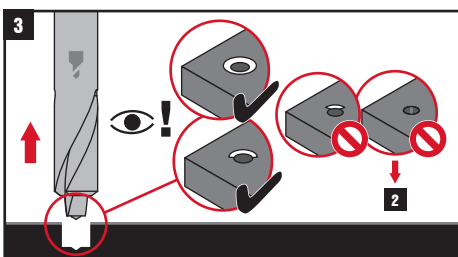
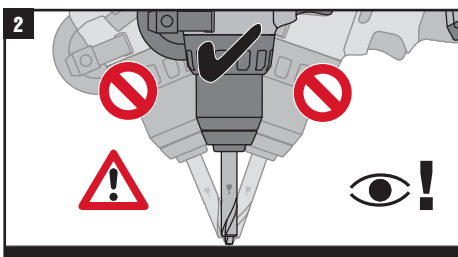
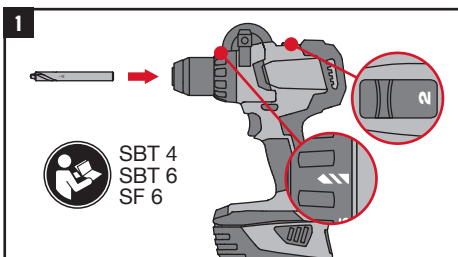

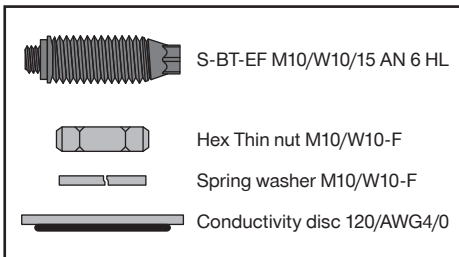
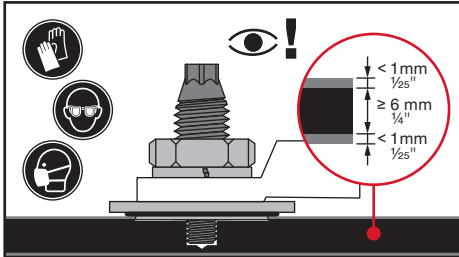

	SBT 6
	TS-BT 5.3-65 S
	TS-BT 5.3 HC
	S-SH BT M10/W10
	Torque Tool S-BT 1/4" 16 Nm / 11.8 lb-ft
	S-NS 15 C 95/3 1/4" S-NS 9/16" C 95/3 1/4"

